



SAW Components

SAW RF filter

Automotive telematics

| | |
|-----------------------|------------------------|
| Series/type: | B3517 |
| Ordering code: | B39162B3517U510 |
| Date: | January 30, 2013 |
| Version: | 2.3 |

Data sheet

Application

- Low-loss RF filter for automotive telematics applications
- Unbalanced to balanced operation
- Low insertion attenuation
- Low amplitude ripple
- Usable passband 42.0 MHz

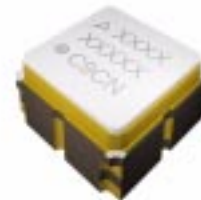
Features

- Package size 3.0 x 3.0 x 1.1 mm³
- Package code DCC6D
- RoHS compatible
- Approximate weight 0.037 g
- Package for **Surface Mount Technology (SMT)**
- Ni, gold-plated terminals
- Lead free soldering compatible with J - STD20C
- **Electrostatic Sensitive Device (ESD)**

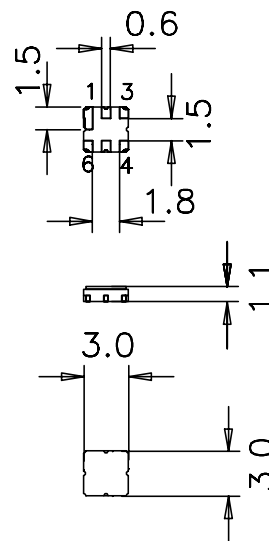
Pin configuration

- 2 Input unbalanced
- 4,6 Output balanced
- 1,3,5 Case ground (to be grounded)

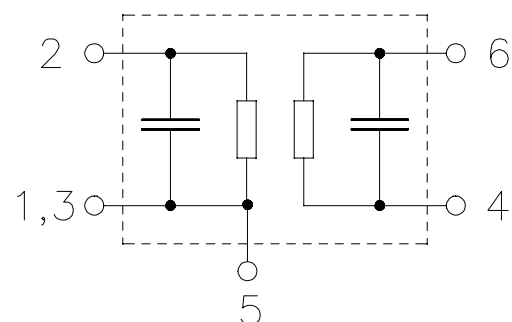

Data sheet

Characteristics

Temperature range for specification: $T = -40\text{ °C to }+85\text{ °C}$
 Terminating source impedance: $Z_S = 50\ \Omega$
 Terminating load impedance: $Z_L = 100\ \Omega \parallel 18\text{ nH (balanced)}$

| | | | | min. | typ. | max. | |
|--|-------------------|-----|-----------------|------|------|------|-----|
| Center frequency | | | f_C | — | 1586 | — | MHz |
| Maximum insertion attenuation | | | α_{\max} | | | | |
| | 1565.0 ... 1607.0 | MHz | | — | 1.9 | 2.5 | dB |
| Amplitude ripple (p-p) | | | $\Delta\alpha$ | | | | |
| | 1565.0 ... 1607.0 | MHz | | — | 0.7 | 1.4 | dB |
| Input VSWR | | | | | | | |
| | 1565.0 ... 1607.0 | MHz | | — | 1.7 | 2.4 | |
| Output VSWR | | | | | | | |
| | 1565.0 ... 1607.0 | MHz | | — | 1.7 | 2.3 | |
| Group delay ripple¹⁾ (p-p) | | | | | | | |
| | 1565.0 ... 1607.0 | MHz | | — | 9 | 20 | ns |
| | 1597.0 ... 1607.0 | MHz | | — | 7 | 14 | ns |
| Attenuation | | | α | | | | |
| | 10.0 ... 960.0 | MHz | | 52 | 57 | — | dB |
| | 960.0 ... 1463.0 | MHz | | 47 | 52 | — | dB |
| | 1710.0 ... 1785.0 | MHz | | 39 | 43 | — | dB |
| | 1785.0 ... 1850.0 | MHz | | 42 | 47 | — | dB |
| | 1850.0 ... 1910.0 | MHz | | 45 | 50 | — | dB |
| | 1910.0 ... 2050.0 | MHz | | 50 | 53 | — | dB |
| | 2050.0 ... 2300.0 | MHz | | 38 | 41 | — | dB |
| | 2300.0 ... 2400.0 | MHz | | 45 | 55 | — | dB |
| | 2400.0 ... 2500.0 | MHz | | 53 | 57 | — | dB |

1) Averaged over 500 kHz

Data sheet

Characteristics

| | |
|--------------------------------------|---|
| Temperature range for specification: | T = -40 °C to +125 °C |
| Terminating source impedance: | Z _S = 50 Ω |
| Terminating load impedance: | Z _L = 100 Ω 18nH (balanced) |

| | | min. | typ. | max. | |
|--|------------------|------|------|------|-----|
| Center frequency | f _C | — | 1586 | — | MHz |
| Maximum insertion attenuation | α _{max} | | | | |
| 1565.0 ... 1607.0 MHz | | — | 1.9 | 2.7 | dB |
| Amplitude ripple (p-p) | Δα | | | | |
| 1565.0 ... 1607.0 MHz | | — | 0.7 | 1.6 | dB |
| Input VSWR | | | | | |
| 1565.0 ... 1607.0 MHz | | — | 1.7 | 2.4 | |
| Output VSWR | | | | | |
| 1565.0 ... 1607.0 MHz | | — | 1.7 | 2.4 | |
| Group delay ripple¹⁾ (p-p) | | | | | |
| 1565.0 ... 1607.0 MHz | | — | 9 | 22 | ns |
| 1597.0 ... 1607.0 MHz | | — | 7 | 16 | ns |
| Attenuation | α | | | | |
| 10.0 ... 960.0 MHz | | 52 | 57 | — | dB |
| 960.0 ... 1463.0 MHz | | 42 | 52 | — | dB |
| 1710.0 ... 1785.0 MHz | | 39 | 43 | — | dB |
| 1785.0 ... 1850.0 MHz | | 42 | 47 | — | dB |
| 1850.0 ... 1910.0 MHz | | 45 | 50 | — | dB |
| 1910.0 ... 2050.0 MHz | | 50 | 53 | — | dB |
| 2050.0 ... 2300.0 MHz | | 38 | 41 | — | dB |
| 2300.0 ... 2400.0 MHz | | 45 | 55 | — | dB |
| 2400.0 ... 2500.0 MHz | | 53 | 57 | — | dB |

1) Averaged over 500 kHz

Maximum ratings

| | | | | |
|----------------------------|------------------|------------------|-----|-------------------------------|
| Operable temperature range | T | -45/+125 | °C | |
| Storage temperature range | T _{stg} | -45/+125 | °C | |
| DC voltage | V _{DC} | 6 | V | |
| ESD voltage | V _{ESD} | 50 ¹⁾ | V | machine model, 10 pulses |
| Input power at | | | | source 50Ω, load 100Ω 18nH |
| 1565.0 ... 1607.0 MHz | P _{IN} | 5 | dBm | cw |
| 2400 ... 2483.5 MHz | P _{IN} | 20 | dBm | cw |
| 824...960, 1710...2170 MHz | P _{IN} | 20 | dBm | cw |
| 960...1525 MHz | P _{IN} | 10 | dBm | cw |

¹⁾ acc. to JESD22-A115A (machine model), 10 negative & 10 positive pulses.

Data sheet



Transfer function

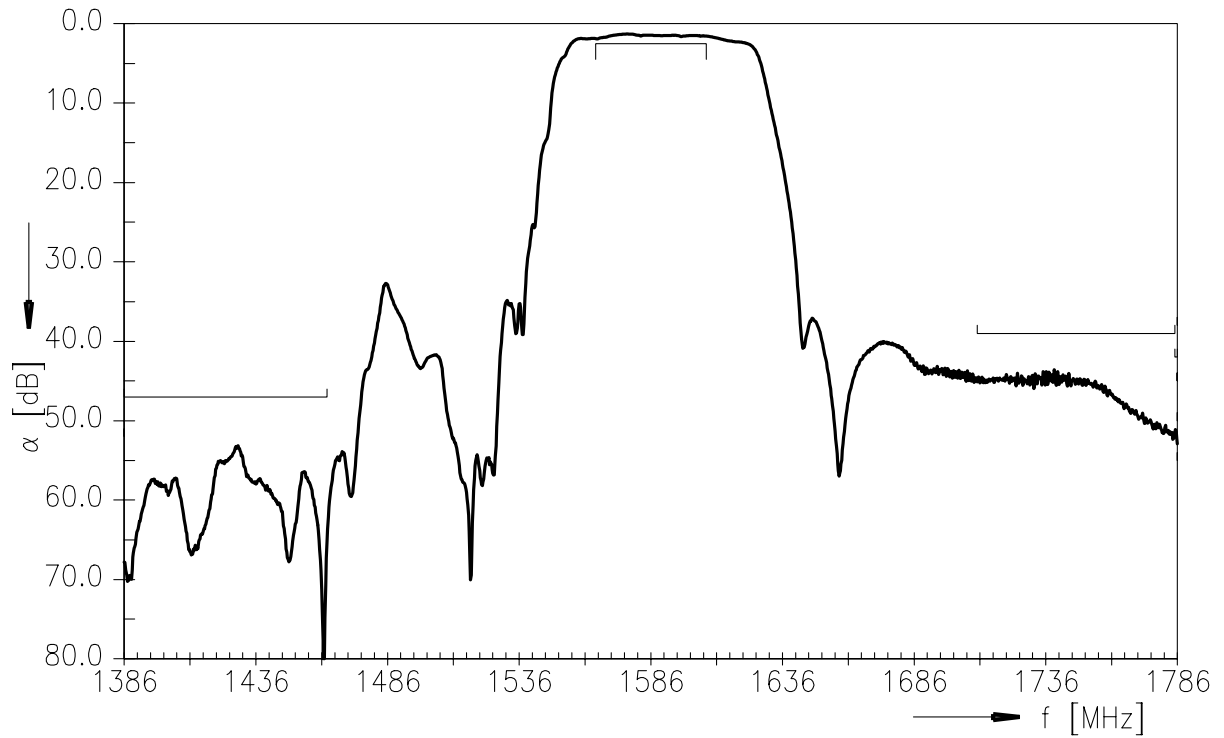

Transfer function (wideband)

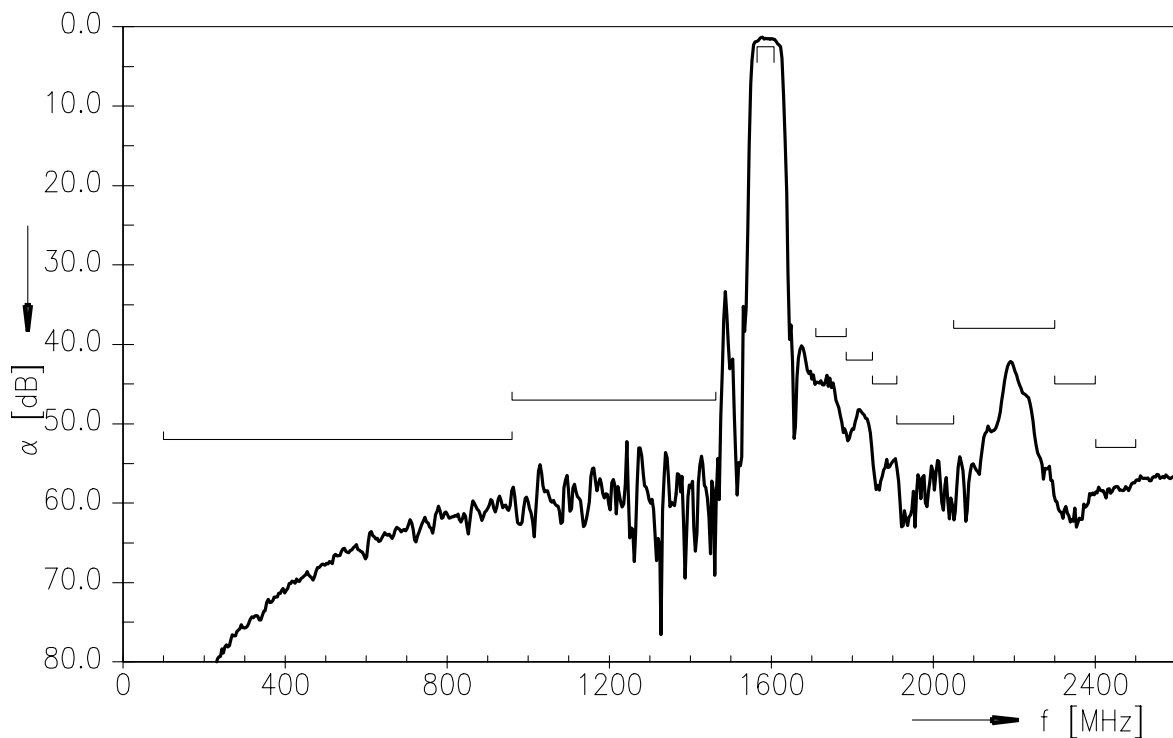



Group delay time

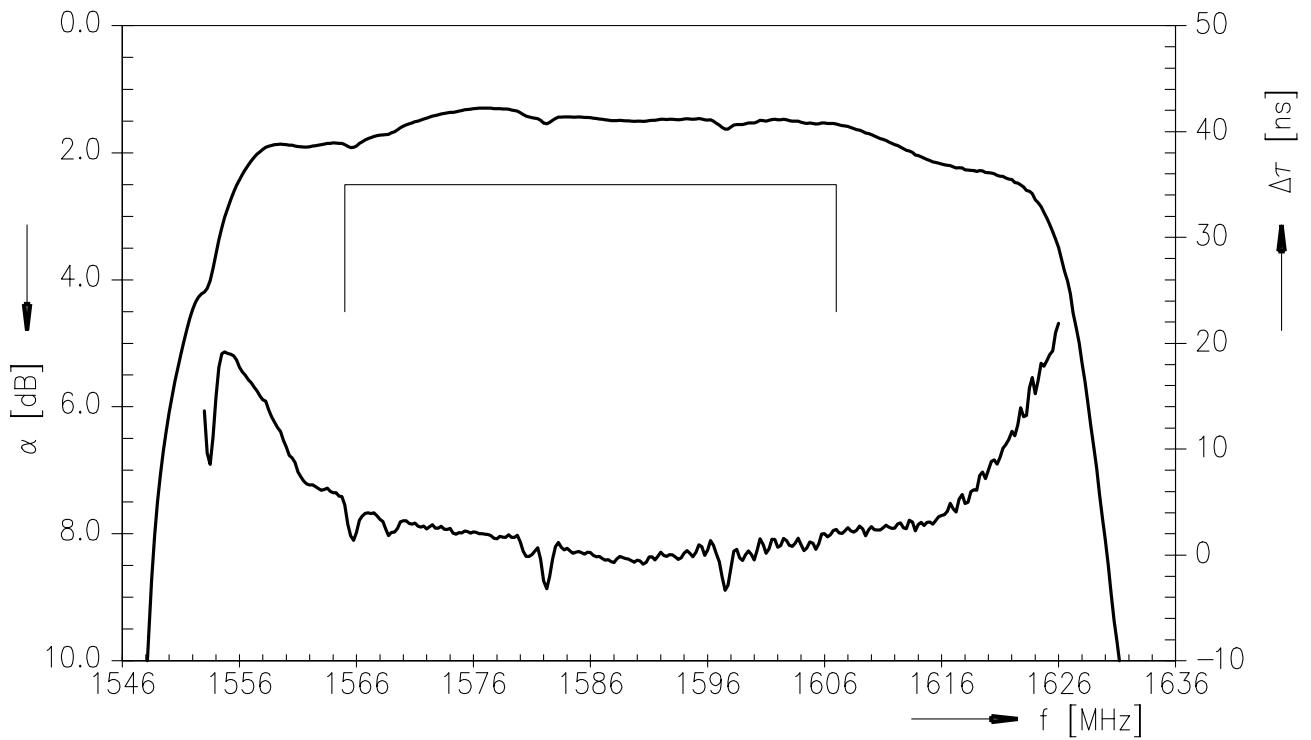



ESD protection of SAW filters

SAW filters are **E**lectro **S**tatic **D**ischarge sensitive devices. To reduce the probability of damages caused by ESD, special matching topologies have to be applied.

In general, “ESD matching” has to be ensured at that filter port, where electrostatic discharge is expected.

Electrostatic discharges predominantly appear at the antenna input of RF receivers. Therefore only the input matching of the SAW filter has to be designed to short circuit or to block the ESD pulse.

Below three figures show recommended “ESD matching” topologies.

For wideband filters the high-pass ESD matching structure needs to be at least of 3rd order to ensure a proper matching for any impedance value of antenna and SAW filter input. The required component values have to be determined from case to case.

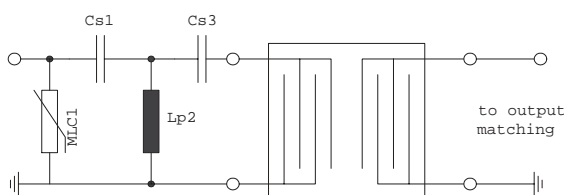

Fig. 1 MLC varistor plus ESD matching

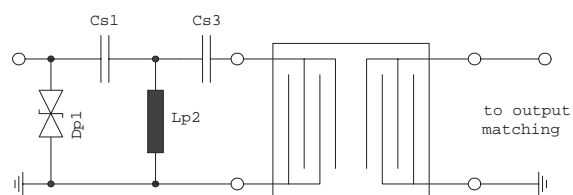

Fig. 2 Suppressor diode plus ESD matching

In cases where minor ESD occur, following simplified “ESD matching” topologies can be used alternatively.

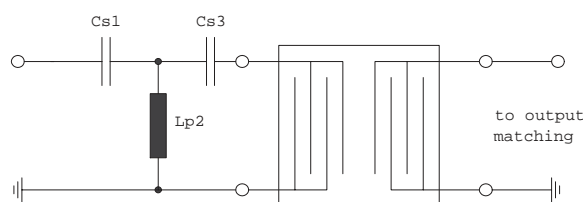

Fig. 3 3rd order high-pass structure for basic ESD protection

In all three figures the shunt inductor Lp2 could be replaced by a shorted microstrip with proper length and width. If this configuration is possible depends on the operating frequency and available pcb space.

Effectiveness of the applied ESD protection has to be checked according to relevant industry standards or customer specific requirements

For further information, please refer to EPCOS Application report:

“ESD protection for SAW filters”.

This report can be found under www.epcos.com/rke. Click on “Applications Notes”.

Data sheet

References

| | |
|----------------------------|---|
| Type | B3517 |
| Ordering code | B39162B3517U510 |
| Marking and package | C61157-A7-A68 |
| Packaging | F61074-V8228-Z000 |
| Date codes | L_1126 |
| S-parameters | B3517_NB.s3p, B3517_WB.s3p see file header for port/pin assignment table |
| Soldering profile | S_6001 |
| RoHS compatible | RoHS-compatible means that products are compatible with the requirements according to Art. 4 (substance restrictions) of Directive 2011/65/EU of the European Parliament and of the Council of June 8 th , 2011, on the restriction of the use of certain hazardous substances in electrical and electronic equipment ("Directive") with due regard to the application of exemptions as per Annex III of the Directive in certain cases. |
| Moldability | Before using in overmolding environment, please contact your EPCOS sales office. |
| Matching coils | See Inductor pdf-catalog http://www.tdk.co.jp/tefe02/coil.htm#aname1 and Data Library for circuit simulation http://www.tdk.co.jp/etvcl/index.htm |

For further information please contact your local EPCOS sales office or visit our webpage at www.epcos.com .

Published by EPCOS AG
Systems, Acoustics, Waves Business Group
P.O. Box 80 17 09, 81617 Munich, GERMANY

© EPCOS AG 2013. This brochure replaces the previous edition.

For questions on technology, prices and delivery please contact the Sales Offices of EPCOS AG or the international Representatives.

Due to technical requirements components may contain dangerous substances. For information on the type in question please also contact one of our Sales Offices.

Important notes

The following applies to all products named in this publication:

1. Some parts of this publication contain **statements about the suitability of our products for certain areas of application**. These statements are based on our knowledge of typical requirements that are often placed on our products in the areas of application concerned. We nevertheless expressly point out **that such statements cannot be regarded as binding statements about the suitability of our products for a particular customer application**. As a rule, EPCOS is either unfamiliar with individual customer applications or less familiar with them than the customers themselves. For these reasons, it is always ultimately incumbent on the customer to check and decide whether an EPCOS product with the properties described in the product specification is suitable for use in a particular customer application.
2. We also point out that **in individual cases, a malfunction of electronic components or failure before the end of their usual service life cannot be completely ruled out in the current state of the art, even if they are operated as specified**. In customer applications requiring a very high level of operational safety and especially in customer applications in which the malfunction or failure of an electronic component could endanger human life or health (e.g. in accident prevention or life-saving systems), it must therefore be ensured by means of suitable design of the customer application or other action taken by the customer (e.g. installation of protective circuitry or redundancy) that no injury or damage is sustained by third parties in the event of malfunction or failure of an electronic component.
3. **The warnings, cautions and product-specific notes must be observed.**
4. In order to satisfy certain technical requirements, **some of the products described in this publication may contain substances subject to restrictions in certain jurisdictions (e.g. because they are classed as hazardous)**. Useful information on this will be found in our Material Data Sheets on the Internet (www.epcos.com/material). Should you have any more detailed questions, please contact our sales offices.
5. We constantly strive to improve our products. Consequently, **the products described in this publication may change from time to time**. The same is true of the corresponding product specifications. Please check therefore to what extent product descriptions and specifications contained in this publication are still applicable before or when you place an order. We also **reserve the right to discontinue production and delivery of products**. Consequently, we cannot guarantee that all products named in this publication will always be available. The aforementioned does not apply in the case of individual agreements deviating from the foregoing for customer-specific products.
6. Unless otherwise agreed in individual contracts, **all orders are subject to the current version of the “General Terms of Delivery for Products and Services in the Electrical Industry” published by the German Electrical and Electronics Industry Association (ZVEI)**.
7. The trade names EPCOS, BAOKE, Alu-X, CeraDiode, CeraLink, CSMP, CSSP, CTVS, DeltaCap, DigiSiMic, DSSP, FilterCap, FormFit, MiniBlue, MiniCell, MKD, MKK, MLSC, MotorCap, PCC, PhaseCap, PhaseCube, PhaseMod, PhiCap, SIFERRIT, SIFI, SIKOREL, SilverCap, SIMDAD, SiMic, SIMID, SineFormer, SIOV, SIP5D, SIP5K, ThermoFuse, WindCap are **trademarks registered or pending** in Europe and in other countries. Further information will be found on the Internet at www.epcos.com/trademarks.