



## Main

Range of Product	Harmony XAC
Product or Component Type	Pendant control station
Device short name	XACA pistol grip

## Complementary

Control station type	Double insulated
Enclosure Material	Polypropylene
Control Type	Intuitive
Electrical circuit type	Control circuit
Enclosure type	Complete ready for use
Control station application	Control of 2-speed hoist motor
Control station composition	2 push-buttons
Control button type	First push-button 2 NO (2 step) raise, slow-fast Second push-button 2 NO (2 step) lower, slow-fast
Product compatibility	ZB2BE101 + ZB2BE201 for each direction
Mechanical interlocking	With mechanical interlocking
Control station colour	Yellow
Connections - terminals	Screw clamp terminals, 1 x 2.5 mm <sup>2</sup> with or without cable end Screw clamp terminals, 2 x 1.5 mm <sup>2</sup> with or without cable end
Standards	EN/IEC 60204-32 CSA C22.2 No 14 UL 508 EN/IEC 60947-5-1
Product Certifications	CSA UL
Protective treatment	TH
Ambient air temperature for operation	-13...158 °F (-25...70 °C)
Ambient Air Temperature for Storage	-40...158 °F (-40...70 °C)
Vibration resistance	15 gn 10...500 Hz)IEC 60068-2-6
Shock resistance	100 gn IEC 60068-2-27
Overvoltage category	Class II IEC 61140
IP degree of protection	IP65 conforming to IEC 60529
IK degree of protection	IK08 EN 50102
Mechanical durability	1000000 cycles
Cable entry	Rubber sleeve with stepped entry 0.28...0.59 in (7...15 mm)
Contact code designation	A600 AC-15, Ue = 240 V, Ie = 3 A IEC 60947-5-1 appendix A A600 AC-15, Ue = 600 V, Ie = 1.2 A IEC 60947-5-1 appendix A Q600 DC-13, Ue = 250 V, Ie = 0.27 A IEC 60947-5-1 appendix A Q600 DC-13, Ue = 600 V, Ie = 0.1 A IEC 60947-5-1 appendix A
[I <sub>th</sub> ] conventional enclosed thermal current	10 A
[U <sub>i</sub> ] rated insulation voltage	600 V 3)IEC 60947-1

[Uimp] rated impulse withstand voltage	6 kV IEC 60947-1
Contact operation	Staggered Slow-break
Maximum resistance across terminals	25 MOhm
Operating force	13...15 N
Short-circuit protection	10 A fuse protection cartridge gG
Rated operational power in W	40 W DC-13 1000000 cycles 60 cyc/mn 120 V 0.5 inductive IEC 60947-5-1 appendix C 48 W DC-13 1000000 cycles 60 cyc/mn 48 V 0.5 inductive IEC 60947-5-1 appendix C 65 W DC-13 1000000 cycles 60 cyc/mn 24 V 0.5 inductive IEC 60947-5-1 appendix C
Terminals description ISO n°1	(3-4)NO
Terminal identifier	AI1, AI2
Net Weight	0.71 lb(US) (0.32 kg)





## Ordering and shipping details

Category	22473 - PUSHBUTTON, PENDANTS
Discount Schedule	CS2
GTIN	3389110645033
Nbr. of units in pkg.	1
Package weight(Lbs)	9.95 oz (282 g)
Returnability	Yes
Country of origin	FR

## Packing Units

Unit Type of Package 1	PCE
Package 1 Height	2.60 in (6.6 cm)
Package 1 width	11.46 in (29.1 cm)
Package 1 Length	4.02 in (10.2 cm)
Unit Type of Package 2	S02
Number of Units in Package 2	6
Package 2 Weight	4.29 lb(US) (1.948 kg)
Package 2 Height	5.91 in (15 cm)
Package 2 width	11.81 in (30 cm)
Package 2 Length	15.75 in (40 cm)

## Offer Sustainability

Sustainable offer status	Green Premium product
California proposition 65	WARNING: This product can expose you to chemicals including: Nickel compounds, which is known to the State of California to cause cancer, and Di-isodecyl phthalate (DIDP), which is known to the State of California to cause birth defects or other reproductive harm. For more information go to <a href="http://www.P65Warnings.ca.gov">www.P65Warnings.ca.gov</a>
REACH Regulation	 <a href="#">REACH Declaration</a>
REACH free of SVHC	Yes
EU RoHS Directive	Pro-active compliance (Product out of EU RoHS legal scope)  <a href="#">EU RoHS Declaration</a>
Toxic heavy metal free	Yes
Mercury free	Yes
RoHS exemption information	 <a href="#">Yes</a>
China RoHS Regulation	 <a href="#">China RoHS Declaration</a>
Environmental Disclosure	 <a href="#">Product Environmental Profile</a>
WEEE	The product must be disposed on European Union markets following specific waste collection and never end up in rubbish bins.

## Contractual warranty

---

Warranty	18 months
----------	-----------

---

Dimensions

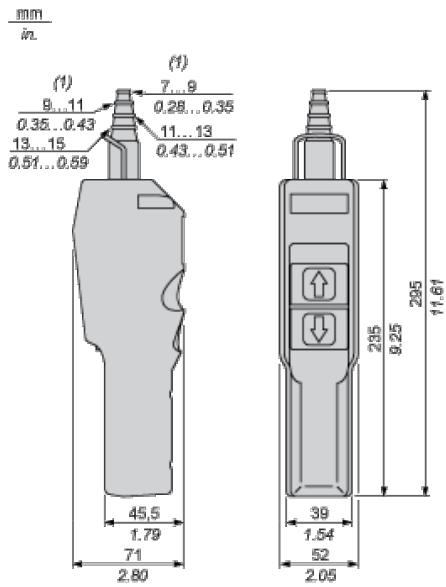

(1) Internal Ø

## Control of 2-Speed Reversing Motor

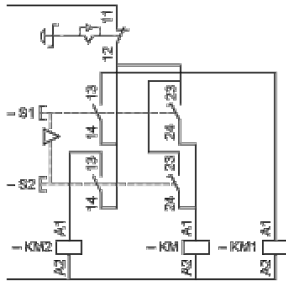

Rated Operational Power

AC Supply 50/60 Hz Inductive Circuit

Operating rate: 3600 operating cycles/hour. Load factor: 0.5.

Millions of operating cycles, AC-15 utilization category

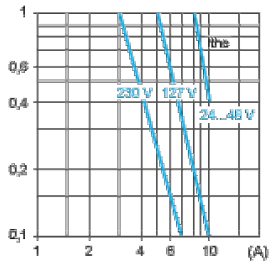

Ithe Thermal current  
(A) Current

DC Supply

Operating rate: 3600 operating cycles/hour. Load factor: 0.5.

Power broken in W for 1 million operating cycles, DC-13 utilization category

Voltage	V	24	48	120
Inductive circuit	W	65	48	40