

61813-1 ✓ ACTIVE

FASTON | Special Purpose Terminals

TE Internal #: 61813-1

Quick Disconnects, Receptacle, 26 – 22 AWG Wire Size, .12 – .32 mm² Wire Size, 254 – 642 CMA Wire Size, Special Purpose Terminals

[View on TE.com >](#)



Terminals & Splices > Quick Disconnects

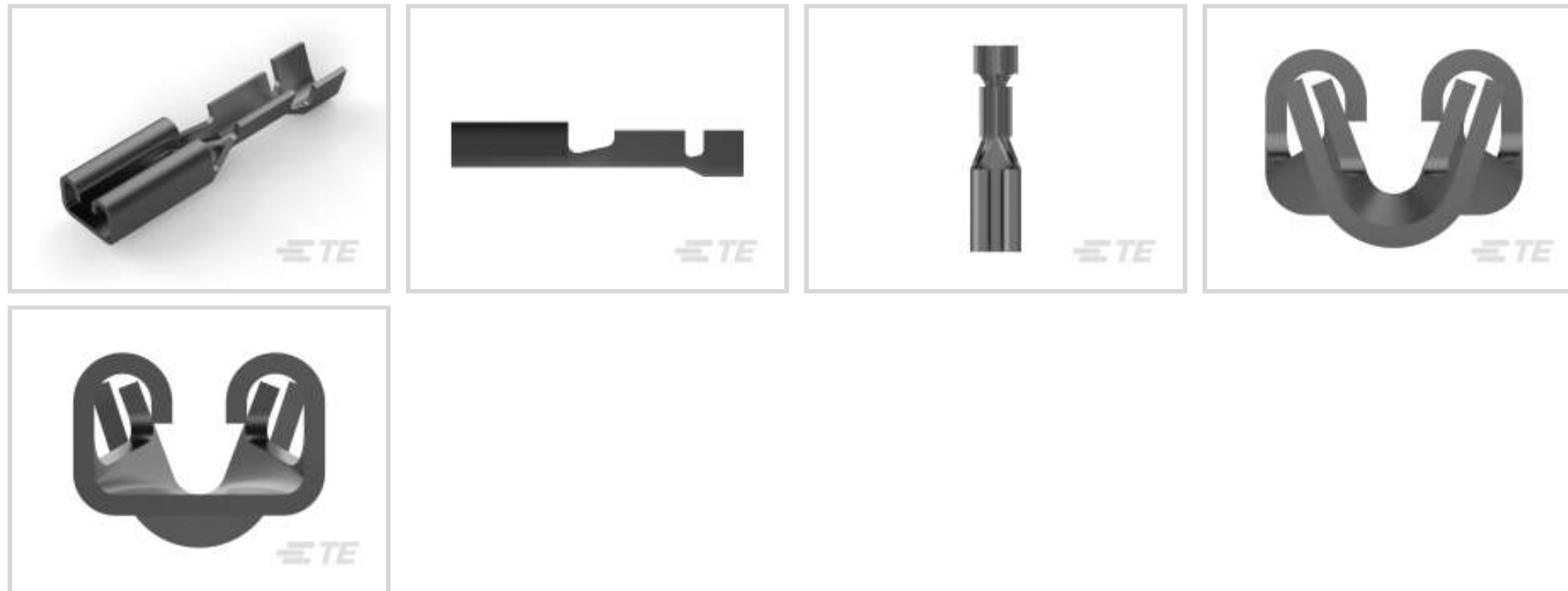

Quick Disconnect Terminal Type: **Receptacle**

Wire Size: **254 – 642 CMA**

Mating Tab Width: **2.36 mm [.093 in]**

Features

Configuration Features

Connection Capacity	Single
Compatible With Wire & Cable Type	Discrete Wire

Contact Features

Quick Disconnect Terminal Type	Receptacle
Mating Tab Width	2.36 mm[.093 in]
Mating Tab Thickness	.81 mm[.032 in]
Terminal Orientation	Straight
Contact Base Material	Brass
Terminal Plating Material	Tin
Crimp Type	F-Crimp
Barrel Type	Open

Termination Features

Product Terminates To	Wire & Cable
-----------------------	--------------

Mechanical Attachment

Wire Insulation Support	With
-------------------------	------

Dimensions



Terminal Material Thickness	.25 mm[.01 in]
Product Length	12.06 mm[.475 in]
Compatible Insulation Diameter Range	.89 – 1.52 mm[.035 – .06 in]
Wire Size	254 – 642 CMA

Usage Conditions

Insulation Option	Uninsulated
Operating Temperature Range	-40 – 105 °C[-40 – 221 °F]

Industry Standards

Agency/Standard	UL
-----------------	----

Packaging Features

Packaging Quantity	30000
Packaging Method	Reel

Other

Line	Budget
------	--------

Product Compliance

[For compliance documentation, visit the product page on TE.com>](#)

















EU RoHS Directive 2011/65/EU	Compliant
EU ELV Directive 2000/53/EC	Compliant
China RoHS 2 Directive MIIT Order No 32, 2016	No Restricted Materials Above Threshold
EU REACH Regulation (EC) No. 1907/2006	Current ECHA Candidate List: JUNE 2023 (235) Candidate List Declared Against: JAN 2023 (233) Does not contain REACH SVHC
Halogen Content	Low Halogen - Br, Cl, F, I < 900 ppm per homogenous material. Also BFR/CFR/PVC Free
Solder Process Capability	Not applicable for solder process capability

Product Compliance Disclaimer

This information is provided based on reasonable inquiry of our suppliers and represents our current actual knowledge based on the information they provided. This information is subject to change. The part numbers that TE has identified as EU RoHS compliant have a maximum concentration of 0.1% by weight in homogenous materials for lead, hexavalent chromium, mercury, PBB, PBDE, DBP, BBP, DEHP, DIBP, and 0.01% for cadmium, or qualify for an exemption to these limits as defined in the Annexes of Directive 2011/65/EU (RoHS2). Finished electrical and electronic equipment products will be CE marked as required by Directive 2011/65/EU. Components may not be CE marked. Additionally, the part numbers that TE has identified as EU ELV compliant have a maximum concentration of 0.1% by weight in homogenous

materials for lead, hexavalent chromium, and mercury, and 0.01% for cadmium, or qualify for an exemption to these limits as defined in the Annexes of Directive 2000/53/EC (ELV). Regarding the REACH Regulation, the information TE provides on SVHC in articles for this part number is based on the latest European Chemicals Agency (ECHA) 'Guidance on requirements for substances in articles' posted at this URL: <https://echa.europa.eu/guidance-documents/guidance-on-reach>

Compatible Parts

 <p>TE Part # 60252-1 103 FASTON REC 22-18 AWG TPBR</p>	 <p>TE Part # 60900-4 WRAP TYPE TAB REC 24-22 AWG TPBR</p>	 <p>TE Part # 63391-2 093 FASTON TAB REC 22-18 AWG TPBR</p>	 <p>TE Part # 1-160760-2 110 FASTON,REC.,30-26 AWG,PTPBR</p>
 <p>TE Part # 42765-1 TAPER TAB 078 REVERSE REEL REC 24-22TPBR</p>	 <p>TE Part # 60432-1 103 FASTON REC 22-18 AWG TPBR</p>	 <p>TE Part # 62352-1 50 FASTON TAB 24-20 AWG TPBZ</p>	 <p>TE Part # 2-4150120-1 OCEAN-2.0-APPLICATOR-E-055F0700</p>
 <p>TE Part # 2-4150120-2 OCEAN-2.0-APPLICATOR-E-055F0700</p>	 <p>TE Part # 4150120-1 OCEAN-2.0-APPLICATOR-E-055F0700</p>	 <p>TE Part # 7-4150120-1 OCEAN-2.0-APPLICATOR-E-055F0700</p>	 <p>TE Part # 7-4150120-2 OCEAN-2.0-APPLICATOR-E-055F0700</p>
 <p>KIT REPRESENTATION ONLY</p> <p>TE Part # 7-4150120-7 OCEAN_2.0_SPARE_PART_KIT-055F0700</p>	 <p>TE Part # 969207-2 FLA-STE-KONT2,8X0,8</p>	 <p>TE Part # 969208-2 FLA-STE-KONT6,3X0,8</p>	 <p>TE Part # 4150120-2 OCEAN-2.0-APPLICATOR-E-055F0700</p>

Also in the Series | [Special Purpose Terminals](#)



PCB Terminals(2)



Quick Disconnects(9)

Customers Also Bought

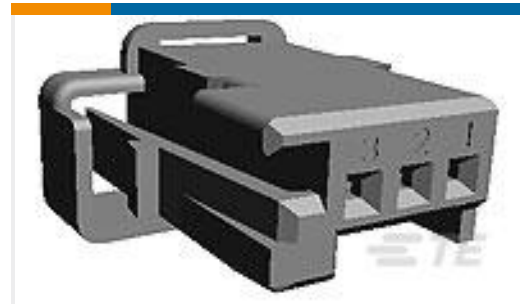
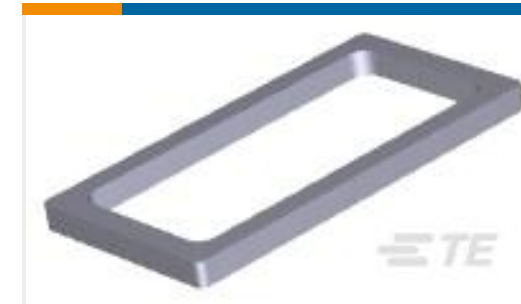
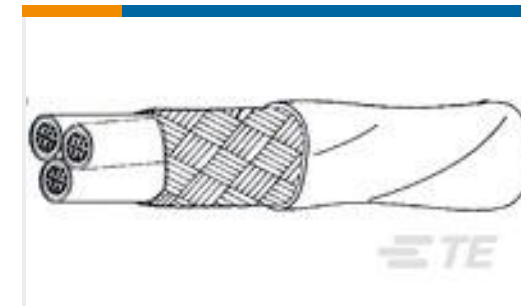
TE Part #35274
TERMINAL,PIDG R 16-14 14TE Part #953697-2
3POS MQS RECTE Part #86561-4
ROUND WIRE PIN L.P.TE Part #1-1586362-6
16P MINI UMNL SEAL, DIE CUTTE Part #3-1825137-8
A105SYZB04TE Part #2-2329387-0
PB OFF/ON FC GRE M1 TERM BLU
LED IP68TE Part #2-2329387-4
PB OFF/ON FC BLU M1 TERM GRE
LED IP68TE Part #599511-000
44AM1131-22-MST3-9CS2275TE Part #5227169-4
BNC - SOLDER RECEPTTE Part #216156-1
44P.HDP22 PLUG ASSY

Documents

Product Drawings

[093 FASTON REC 26-22 AWG TPBR](#)

English

CAD Files

[Customer View Model](#)

[ENG_CVM_CVM_61813-1_P.2d_dxf.zip](#)

English

[3D PDF](#)



3D

Customer View Model

[ENG_CVM_CVM_61813-1_P.3d_igs.zip](#)

English

Customer View Model

[ENG_CVM_CVM_61813-1_P.3d_stp.zip](#)

English

By downloading the CAD file I accept and agree to the [Terms and Conditions](#) of use.

Datasheets & Catalog Pages

[82004 FASTON Terminals \(Insulated and Uninsulated\) Catalog - FASTON Receptacles Section](#)

English