

TL1963A-Q1 1.5-A Low-Noise Fast-Transient-Response Low-Dropout Regulator

1 Features

- Qualified for Automotive Applications
- AEC-Q100 Test Guidance With the Following:
 - Device Temperature Grade 1: -40°C to 125°C Ambient Operating Temperature
 - Device HBM ESD Classification Level 2
 - Device CDM ESD Classification Level C6
- Optimized for Fast Transient Response
- Output Current: 1.5 A
- Dropout Voltage: 340 mV
- Low Noise: $40\ \mu\text{V}_{\text{RMS}}$ (10 Hz to 100 kHz)
- 1-mA Quiescent Current
- No Protection Diodes Required
- Controlled Quiescent Current in Dropout
- Fixed Output Voltages: 1.5 V, 1.8 V, 2.5 V, and 3.3 V
- Adjustable Output Voltage: 1.21 V to 20 V
- Less Than $1\text{-}\mu\text{A}$ Quiescent Current in Shutdown
- Stable With $10\text{-}\mu\text{F}$ Output Capacitor
- Stable With Ceramic Capacitors
- Reverse-Battery Protection
- No Reverse Current
- Thermal Limiting

2 Applications

- 3.3-V to 2.5-V Logic Power Supplies
- Post Regulator for Switching Supplies

3 Description

The TL1963A-Q1 device is a low-dropout (LDO) regulator optimized for fast transient response. The device can supply 1.5 A of output current with a dropout voltage of 340 mV. Operating quiescent current is 1 mA, dropping to less than $1\ \mu\text{A}$ in shutdown. Quiescent current is well controlled; it does not rise in dropout as it does with many other regulators. In addition to fast transient response, the TL1963A-Q1 regulators have very low output noise, which makes them ideal for sensitive RF supply applications.

Output voltage range is from 1.21 V to 20 V. The TL1963A-Q1 regulators are stable with output capacitors as low as $10\ \mu\text{F}$. Small ceramic capacitors can be used without the necessary addition of ESR, as is common with other regulators. Internal protection circuitry includes reverse-battery protection, current limiting, thermal limiting, and reverse-current protection. The devices are available in fixed output voltages of 1.5 V, 1.8 V, 2.5 V, and 3.3 V, and as an adjustable device with a 1.21-V reference voltage. The TL1963A-Q1 regulators are available in the 5-pin TO-263 (KTT) package.

Device Information⁽¹⁾

PART NUMBER	PACKAGE	BODY SIZE (NOM)
TL1963A-Q1	TO-263 (5)	10.16 mm × 8.42 mm

(1) For all available packages, see the orderable addendum at the end of the data sheet.

Simplified Schematic

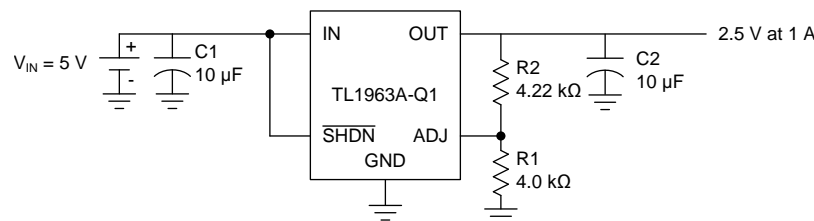

Copyright © 2016, Texas Instruments Incorporated



Table of Contents

1 Features	1	7.4 Device Functional Modes.....	14
2 Applications	1	8 Application and Implementation	15
3 Description	1	8.1 Application Information.....	15
4 Revision History	2	8.2 Typical Application	15
5 Pin Configuration and Functions	3	9 Power Supply Recommendations	20
6 Specifications	4	10 Layout	20
6.1 Absolute Maximum Ratings	4	10.1 Layout Guidelines	20
6.2 ESD Ratings.....	4	10.2 Layout Example	21
6.3 Recommended Operating Conditions	4	10.3 Calculating Junction Temperature	21
6.4 Thermal Information	4	11 Device and Documentation Support	22
6.5 Electrical Characteristics.....	5	11.1 Receiving Notification of Documentation Updates	22
6.6 Typical Characteristics	7	11.2 Community Resources.....	22
7 Detailed Description	12	11.3 Trademarks	22
7.1 Overview	12	11.4 Electrostatic Discharge Caution.....	22
7.2 Functional Block Diagram	12	11.5 Glossary	22
7.3 Feature Description.....	12	12 Mechanical, Packaging, and Orderable Information	22

4 Revision History

NOTE: Page numbers for previous revisions may differ from page numbers in the current version.

Changes from Original (April 2010) to Revision A	Page
• Added <i>ESD Ratings</i> table, <i>Feature Description</i> section, <i>Device Functional Modes</i> , <i>Application and Implementation</i> section, <i>Power Supply Recommendations</i> section, <i>Layout</i> section, <i>Device and Documentation Support</i> section, and <i>Mechanical, Packaging, and Orderable Information</i> section	1
• Deleted <i>Ordering Information</i> table, see POA at the end of the data sheet.....	1
• Added AEC-Q100 Test Guidance bullets to <i>Features</i>	1
• Changed $R_{\theta JA}$ from 26.5°C/W : to 22.8°C/W	4
• Changed $R_{\theta JC(top)}$ from 24.1°C/W : to 36.5°C/W	4
• Changed $R_{\theta JC(bot)}$ from 0.38°C/W : to 1.1°C/W	4
• Changed x-axis on <i>Line Transient Response</i> graph from TBD $\mu\text{s}/\text{div}$ to 500 $\mu\text{s}/\text{div}$	11

5 Pin Configuration and Functions

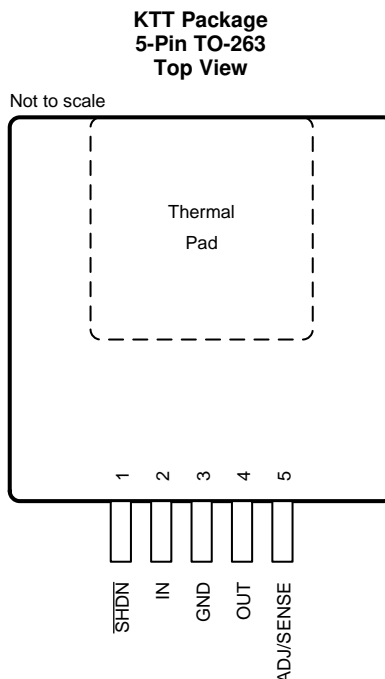

Pin Functions

PIN		I/O	DESCRIPTION
NO.	NAME		
1	$\overline{\text{SHDN}}$	I	Shutdown – The $\overline{\text{SHDN}}$ pin is used to put the TL1963A-Q1 regulators into a low-power shutdown state. The output is off when the $\overline{\text{SHDN}}$ pin is pulled low. The $\overline{\text{SHDN}}$ pin can be driven either by 5-V logic or open-collector logic with a pullup resistor. The pullup resistor is required to supply the pullup current of the open-collector gate, normally several microamperes, and the $\overline{\text{SHDN}}$ pin current, typically 3 μA . If unused, the $\overline{\text{SHDN}}$ pin must be connected to V_{IN} . The device is in the low-power shutdown state if the $\overline{\text{SHDN}}$ pin is not connected.
2	IN	I	Input – Power is supplied to the device through the IN pin. A bypass capacitor is required on this pin if the device is more than six inches away from the main input filter capacitor. In general, the output impedance of a battery rises with frequency, so it is advisable to include a bypass capacitor in battery-powered circuits. A bypass capacitor (ceramic) in the range of 1 μF to 10 μF is sufficient. The TL1963A-Q1 regulators are designed to withstand reverse voltages on the IN pin with respect to ground and the OUT pin. In the case of a reverse input, which can happen if a battery is plugged in backwards, the device acts as if there is a diode in series with its input. There is no reverse current flow into the regulator, and no reverse voltage appears at the load. The device protects both itself and the load.
3	GND	—	Ground
4	OUT	O	Output – The output supplies power to the load. A minimum output capacitor (ceramic) of 10 μF is required to prevent oscillations. Larger output capacitors are required for applications with large transient loads to limit peak voltage transients.
5	ADJ/SENSE	I	Adjust – For the adjustable TL1963A-Q1, this is the input to the error amplifier. This pin is clamped internally to $\pm 7\text{ V}$. It has a bias current of 3 μA that flows into the pin. The ADJ pin voltage is 1.21 V referenced to ground, and the output voltage range is 1.21 V to 20 V. Sense – For fixed voltage versions of the TL1963A-Q1 (TL1963A-Q1-1.5, TL1963A-Q1-1.8, TL1963A-Q1-2.5, and TL1963A-Q1-3.3), the SENSE pin is the input to the error amplifier. Optimum regulation is obtained at the point where the SENSE pin is connected to the OUT pin of the regulator. In critical applications, small voltage drops are caused by the resistance (R_{P}) of printed-circuit traces between the regulator and the load. These may be eliminated by connecting the SENSE pin to the output at the load. Note that the voltage drop across the external printed-circuit traces adds to the dropout voltage of the regulator. The SENSE pin bias current is 600 μA at the rated output voltage. The SENSE pin can be pulled below ground (as in a dual supply system in which the regulator load is returned to a negative supply) and still allow the device to start and operate.
–	Thermal Pad	—	For the KTT package, the exposed thermal pad is connected to ground and must be soldered to the PCB for rated thermal performance.

6 Specifications

6.1 Absolute Maximum Ratings

 over operating free-air temperature range (unless otherwise noted)⁽¹⁾

		MIN	MAX	UNIT
Input voltage, V_{IN}	IN	-20	20	V
	OUT	-20	20	
	Input-to-output differential ⁽²⁾	-20	20	
	SENSE	-20	20	
	ADJ	-7	7	
	SHDN	-20	20	
Output short-circuit duration, t_{short}		Indefinite		
Operating junction temperature, T_J		-40	125	°C
Storage temperature, T_{stg}		-65	150	°C

- (1) Stresses beyond those listed under *Absolute Maximum Ratings* may cause permanent damage to the device. These are stress ratings only, which do not imply functional operation of the device at these or any other conditions beyond those indicated under *Recommended Operating Conditions*. Exposure to absolute-maximum-rated conditions for extended periods may affect device reliability.
- (2) Absolute maximum input-to-output differential voltage cannot be achieved with all combinations of rated IN pin and OUT pin voltages. With the IN pin at 20 V, the OUT pin may not be pulled below 0 V. The total measured voltage from IN to OUT cannot exceed ± 20 V.

6.2 ESD Ratings

		VALUE	UNIT
$V_{(ESD)}$ Electrostatic discharge	Human-body model (HBM), per ANSI/ESDA/JEDEC JS-001 ⁽¹⁾	± 2000	V
	Charged-device model (CDM), per JEDEC specification JESD22-C101 ⁽²⁾	± 1000	

- (1) JEDEC document JEP155 states that 500-V HBM allows safe manufacturing with a standard ESD control process.
- (2) JEDEC document JEP157 states that 250-V CDM allows safe manufacturing with a standard ESD control process.

6.3 Recommended Operating Conditions

over operating free-air temperature range (unless otherwise noted)

		MIN	MAX	UNIT
V_{IN}	Input voltage	$V_{OUT} + V_{DO}$	20	V
V_{IH}	$\overline{\text{SHDN}}$ high-level input voltage	2	20	V
V_{IL}	$\overline{\text{SHDN}}$ low-level input voltage		0.25	V
T_J	Operating junction temperature	-40	125	°C

6.4 Thermal Information

THERMAL METRIC ⁽¹⁾		TL1963A-Q1	UNIT
		KTT (TO-263)	
		5 PINS	
$R_{\theta JA}$	Junction-to-ambient thermal resistance	22.8	°C/W
$R_{\theta JC(top)}$	Junction-to-case (top) thermal resistance	36.5	°C/W
$R_{\theta JB}$	Junction-to-board thermal resistance	6.8	°C/W
Ψ_{JT}	Junction-to-top characterization parameter	3.2	°C/W
Ψ_{JB}	Junction-to-board characterization parameter	6.8	°C/W
$R_{\theta JC(bot)}$	Junction-to-case (bottom) thermal resistance	1.1	°C/W

- (1) For more information about traditional and new thermal metrics, see the [Semiconductor and IC Package Thermal Metrics](#) application report.

6.5 Electrical Characteristics

Over operating temperature range $T_J = -40^{\circ}\text{C}$ to 125°C (unless otherwise noted)⁽¹⁾

PARAMETER		TEST CONDITIONS		MIN	TYP ⁽²⁾	MAX	UNIT
V_{IN}	Minimum input voltage ⁽³⁾⁽⁴⁾	$I_{LOAD} = 0.5\text{ A}$, $T_J = 25^{\circ}\text{C}$		1.9			V
		$I_{LOAD} = 1.5\text{ A}$, $T_J = -40^{\circ}\text{C}$ to 125°C		2.1	2.5		
V_{OUT}	Regulated output voltage ⁽⁵⁾	TL1963A-Q1-1.5	$V_{IN} = 2.21\text{ V}$, $I_{LOAD} = 1\text{ mA}$, $T_J = 25^{\circ}\text{C}$	1.477	1.5	1.523	V
			$V_{IN} = 2.5\text{ V}$ to 20 V , $I_{LOAD} = 1\text{ mA}$ to 1.5 A , $T_J = -40^{\circ}\text{C}$ to 125°C	1.447	1.5	1.545	
		TL1963A-Q1-1.8	$V_{IN} = 2.3\text{ V}$, $I_{LOAD} = 1\text{ mA}$, $T_J = 25^{\circ}\text{C}$	1.773	1.8	1.827	
			$V_{IN} = 2.8\text{ V}$ to 20 V , $I_{LOAD} = 1\text{ mA}$ to 1.5 A , $T_J = -40^{\circ}\text{C}$ to 125°C	1.737	1.8	1.854	
		TL1963A-Q1-2.5	$V_{IN} = 3\text{ V}$, $I_{LOAD} = 1\text{ mA}$, $T_J = 25^{\circ}\text{C}$	2.462	2.5	2.538	
			$V_{IN} = 3.5\text{ V}$ to 20 V , $I_{LOAD} = 1\text{ mA}$ to 1.5 A , $T_J = -40^{\circ}\text{C}$ to 125°C	2.412	2.5	2.575	
		TL1963A-Q1-3.3	$V_{IN} = 3.8\text{ V}$, $I_{LOAD} = 1\text{ mA}$, $T_J = 25^{\circ}\text{C}$	3.25	3.3	3.35	
			$V_{IN} = 4.3\text{ V}$ to 20 V , $I_{LOAD} = 1\text{ mA}$ to 1.5 A , $T_J = -40^{\circ}\text{C}$ to 125°C	3.2	3.3	3.4	
V_{ADJ}	ADJ pin voltage ⁽³⁾⁽⁵⁾	TL1963A-Q1	$V_{IN} = 2.21\text{ V}$, $I_{LOAD} = 1\text{ mA}$, $T_J = 25^{\circ}\text{C}$	1.192	1.21	1.228	V
			$V_{IN} = 2.5\text{ V}$ to 20 V , $I_{LOAD} = 1\text{ mA}$ to 1.5 A , $T_J = -40^{\circ}\text{C}$ to 125°C	1.174	1.21	1.246	
Line regulation		TL1963A-Q1-1.5, $\Delta V_{IN} = 2.21\text{ V}$ to 20 V , $I_{LOAD} = 1\text{ mA}$, $T_J = -40^{\circ}\text{C}$ to 125°C	2		6	mV	
		TL1963A-Q1-1.8, $\Delta V_{IN} = 2.3\text{ V}$ to 20 V , $I_{LOAD} = 1\text{ mA}$, $T_J = -40^{\circ}\text{C}$ to 125°C	2.5		7		
		TL1963A-Q1-2.5, $\Delta V_{IN} = 3\text{ V}$ to 20 V , $I_{LOAD} = 1\text{ mA}$, $T_J = -40^{\circ}\text{C}$ to 125°C	3		10		
		TL1963A-Q1-3.3, $\Delta V_{IN} = 3.8\text{ V}$ to 20 V , $I_{LOAD} = 1\text{ mA}$, $T_J = -40^{\circ}\text{C}$ to 125°C	3.5		10		
		TL1963A-Q1 ⁽³⁾ , $\Delta V_{IN} = 2.21\text{ V}$ to 20 V , $I_{LOAD} = 1\text{ mA}$, $T_J = -40^{\circ}\text{C}$ to 125°C	1.5		5		
Load regulation		TL1963A-Q1-1.5, $V_{IN} = 2.5\text{ V}$, $\Delta I_{LOAD} = 1\text{ mA}$ to 1.5 A	$T_J = 25^{\circ}\text{C}$	2	9	mV	
			$T_J = -40^{\circ}\text{C}$ to 125°C	18			
		TL1963A-Q1-1.8, $V_{IN} = 2.8\text{ V}$, $\Delta I_{LOAD} = 1\text{ mA}$ to 1.5 A	$T_J = 25^{\circ}\text{C}$	2	10		
			$T_J = -40^{\circ}\text{C}$ to 125°C	20			
		TL1963A-Q1-2.5, $V_{IN} = 3.5\text{ V}$, $\Delta I_{LOAD} = 1\text{ mA}$ to 1.5 A	$T_J = 25^{\circ}\text{C}$	2.5	15		
			$T_J = -40^{\circ}\text{C}$ to 125°C	30			
		TL1963A-Q1-3.3, $V_{IN} = 4.3\text{ V}$, $\Delta I_{LOAD} = 1\text{ mA}$ to 1.5 A	$T_J = 25^{\circ}\text{C}$	3	20		
			$T_J = -40^{\circ}\text{C}$ to 125°C	70			
		TL1963A-Q1 ⁽³⁾ , $V_{IN} = 2.5\text{ V}$, $\Delta I_{LOAD} = 1\text{ mA}$ to 1.5 A	$T_J = 25^{\circ}\text{C}$	2	8		
			$T_J = -40^{\circ}\text{C}$ to 125°C	18			

- (1) The TL1963A-Q1 regulators are tested and specified under pulse load conditions such that $T_J \approx T_A$. The TL1963A-Q1 is fully tested at $T_A = 25^{\circ}\text{C}$. Performance at -40°C and 125°C is specified by design, characterization, and correlation with statistical process controls.
- (2) Typical values represent the likely parametric nominal values determined at the time of characterization. Typical values depend on the application and configuration and may vary over time. Typical values are not ensured on production material.
- (3) The TL1963A-Q1 (adjustable version) is tested and specified for these conditions with the ADJ pin connected to the OUT pin.
- (4) For the TL1963A-Q1, TL1963A-Q1-1.5 and TL1963A-Q1-1.8, dropout voltages are limited by the minimum input voltage specification under some output voltage and load conditions.
- (5) Operating conditions are limited by maximum junction temperature. The regulated output voltage specification does not apply for all possible combinations of input voltage and output current. When operating at maximum input voltage, the output current range must be limited. When operating at maximum output current, the input voltage range must be limited.

Electrical Characteristics (continued)

 Over operating temperature range $T_J = -40^{\circ}\text{C}$ to 125°C (unless otherwise noted)⁽¹⁾

PARAMETER		TEST CONDITIONS	MIN	TYP ⁽²⁾	MAX	UNIT
V_{DROPOUT}	Dropout voltage ⁽⁴⁾⁽⁶⁾⁽⁷⁾ $V_{\text{IN}} = V_{\text{OUT(NOMINAL)}}$	$I_{\text{LOAD}} = 1 \text{ mA}$	$T_J = 25^{\circ}\text{C}$	0.02	0.06	V
			$T_J = -40^{\circ}\text{C}$ to 125°C		0.1	
		$I_{\text{LOAD}} = 100 \text{ mA}$	$T_J = 25^{\circ}\text{C}$	0.1	0.17	
			$T_J = -40^{\circ}\text{C}$ to 125°C		0.22	
		$I_{\text{LOAD}} = 500 \text{ mA}$	$T_J = 25^{\circ}\text{C}$	0.19	0.27	
			$T_J = -40^{\circ}\text{C}$ to 125°C		0.35	
		$I_{\text{LOAD}} = 1.5 \text{ A}$	$T_J = 25^{\circ}\text{C}$	0.34	0.45	
			$T_J = -40^{\circ}\text{C}$ to 125°C		0.55	
I_{GND}	GND pin current ⁽⁷⁾⁽⁸⁾ $V_{\text{IN}} = V_{\text{OUT(NOMINAL)}} + 1$	$I_{\text{LOAD}} = 0 \text{ mA}, T_J = -40^{\circ}\text{C}$ to 125°C		1	1.5	mA
		$I_{\text{LOAD}} = 1 \text{ mA}, T_J = -40^{\circ}\text{C}$ to 125°C		1.1	1.6	
		$I_{\text{LOAD}} = 100 \text{ mA}, T_J = -40^{\circ}\text{C}$ to 125°C		3.8	5.5	
		$I_{\text{LOAD}} = 500 \text{ mA}, T_J = -40^{\circ}\text{C}$ to 125°C		15	25	
		$I_{\text{LOAD}} = 1.5 \text{ A}, T_J = -40^{\circ}\text{C}$ to 125°C		80	120	
e_{N}	Output voltage noise	$C_{\text{OUT}} = 10 \mu\text{F}, I_{\text{LOAD}} = 1.5 \text{ A}, B_{\text{W}} = 10 \text{ Hz}$ to $100 \text{ kHz}, T_J = 25^{\circ}\text{C}$		40		μV_{RMS}
I_{ADJ}	ADJ pin bias current ⁽³⁾⁽⁹⁾	$T_J = 25^{\circ}\text{C}$		3	10	μA
	Shutdown threshold	$V_{\text{OUT}} = \text{OFF}$ to $\text{ON}, T_J = -40^{\circ}\text{C}$ to 125°C		0.9	2	V
		$V_{\text{OUT}} = \text{ON}$ to $\text{OFF}, T_J = -40^{\circ}\text{C}$ to 125°C		0.25	0.75	
I_{SHDN}	$\overline{\text{SHDN}}$ pin current	$V_{\text{SHDN}} = 0 \text{ V}, T_J = 25^{\circ}\text{C}$		0.01	1	μA
		$V_{\text{SHDN}} = 20 \text{ V}, T_J = 25^{\circ}\text{C}$		3	30	
	Quiescent current in shutdown	$V_{\text{IN}} = 6 \text{ V}, V_{\text{SHDN}} = 0 \text{ V}, T_J = 25^{\circ}\text{C}$		0.01	1	μA
	Ripple rejection	$V_{\text{IN}} - V_{\text{OUT}} = 1.5 \text{ V (avg)}, V_{\text{RIPPLE}} = 0.5 \text{ V}_{\text{P-P}}, f_{\text{RIPPLE}} = 120 \text{ Hz}, I_{\text{LOAD}} = 0.75 \text{ A}, T_J = 25^{\circ}\text{C}$		55	63	dB
I_{LIMIT}	Current limit	$V_{\text{IN}} = 7 \text{ V}, V_{\text{OUT}} = 0 \text{ V}, T_J = 25^{\circ}\text{C}$		2		A
		$V_{\text{IN}} = V_{\text{OUT(NOMINAL)}} + 1, T_J = -40^{\circ}\text{C}$ to 125°C		1.6		
I_{IL}	Input reverse leakage current	$V_{\text{IN}} = -20 \text{ V}, V_{\text{OUT}} = 0 \text{ V}, T_J = -40^{\circ}\text{C}$ to 125°C			1	mA
I_{RO}	Reverse output current ⁽¹⁰⁾	TL1963A-Q1-1.5, $V_{\text{OUT}} = 1.5 \text{ V}, V_{\text{IN}} < 1.5 \text{ V}, T_J = 25^{\circ}\text{C}$		600	1200	μA
		TL1963A-Q1-1.8, $V_{\text{OUT}} = 1.8 \text{ V}, V_{\text{IN}} < 1.8 \text{ V}, T_J = 25^{\circ}\text{C}$		600	1200	
		TL1963A-Q1-2.5, $V_{\text{OUT}} = 2.5 \text{ V}, V_{\text{IN}} < 2.5 \text{ V}, T_J = 25^{\circ}\text{C}$		600	1200	
		TL1963A-Q1-3.3, $V_{\text{OUT}} = 3.3 \text{ V}, V_{\text{IN}} < 3.3 \text{ V}, T_J = 25^{\circ}\text{C}$		600	1200	
		TL1963A-Q1, $V_{\text{OUT}} = 1.21 \text{ V}, V_{\text{IN}} < 1.21 \text{ V}, T_J = 25^{\circ}\text{C}$		300	600	

- (6) Dropout voltage is the minimum input to output voltage differential required to maintain regulation at a specified output current. In dropout, the output voltage is equal to: $V_{\text{IN}} - V_{\text{DROPOUT}}$.
- (7) To satisfy requirements for minimum input voltage, the TL1963A-Q1 (adjustable version) is tested and specified for these conditions with an external resistor divider (two 4.12-k Ω resistors) for an output voltage of 2.4 V. The external resistor divider adds a 300-mA DC load on the output.
- (8) GND pin current is tested with $V_{\text{IN}} = (V_{\text{OUT(NOMINAL)}} + 1 \text{ V})$ and a current source load. The GND pin current decreases at higher input voltages.
- (9) ADJ pin bias current flows into the ADJ pin.
- (10) Reverse output current is tested with the IN pin grounded and the OUT pin forced to the rated output voltage. This current flows into the OUT pin and out the GND pin.

6.6 Typical Characteristics

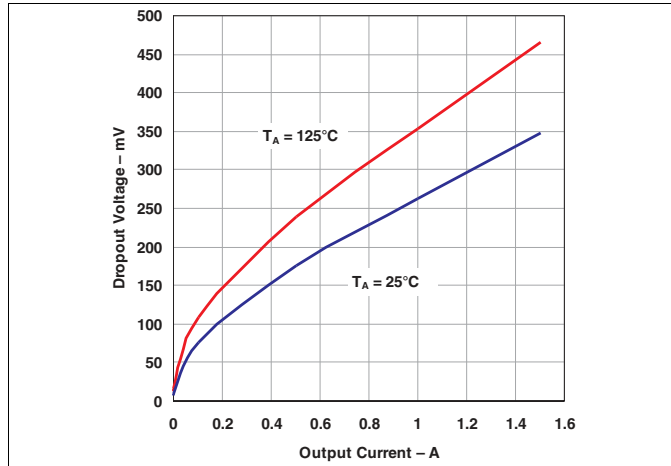

Figure 1. Dropout Voltage vs Output Current

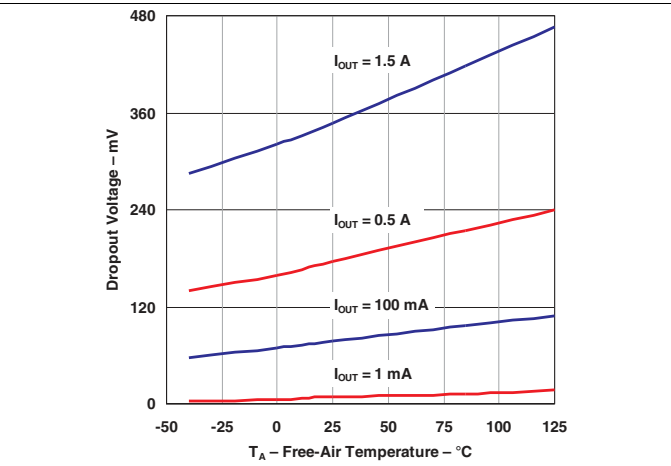

Figure 2. Dropout Voltage vs Temperature

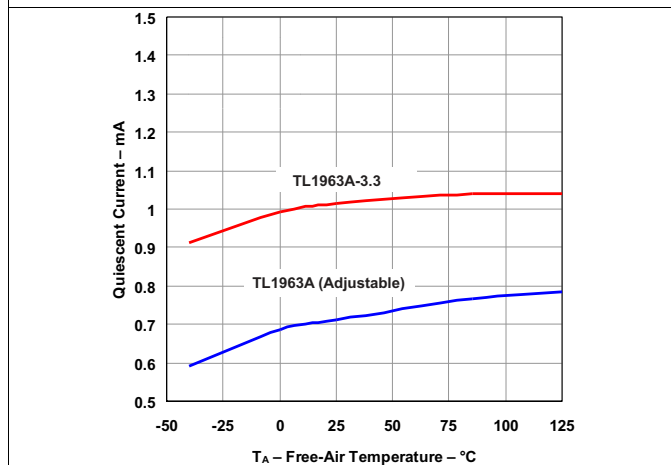

Figure 3. Quiescent Current vs Temperature

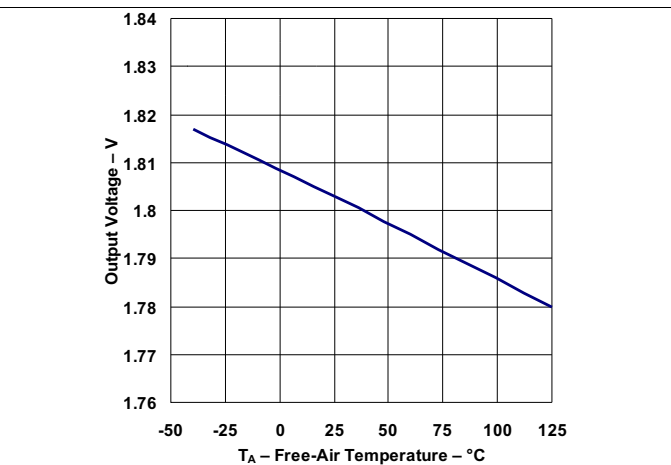

Figure 4. Output Voltage vs Temperature

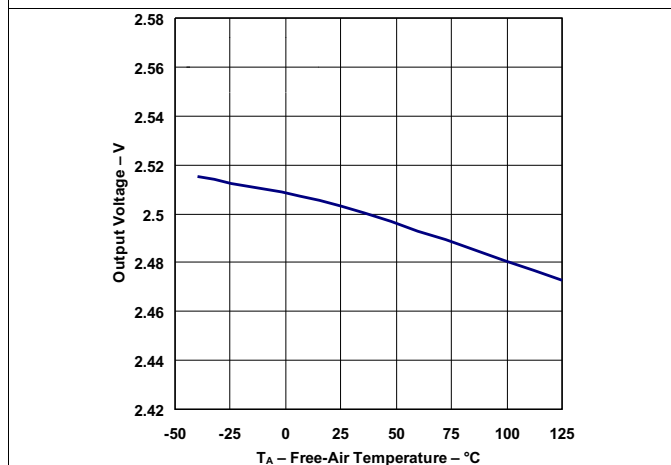

Figure 5. Output Voltage vs Temperature

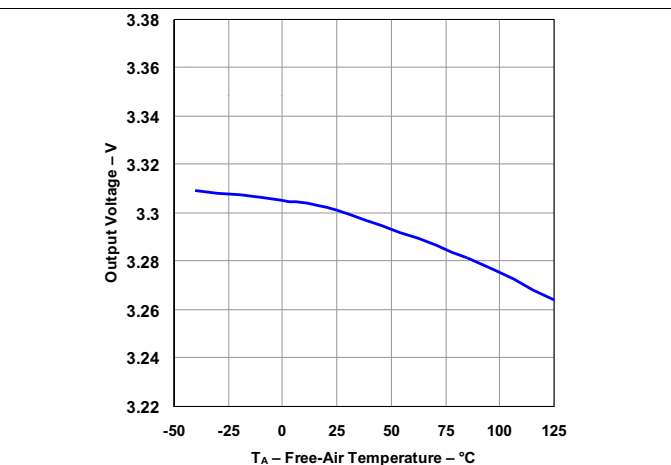

Figure 6. Output Voltage vs Temperature

Typical Characteristics (continued)

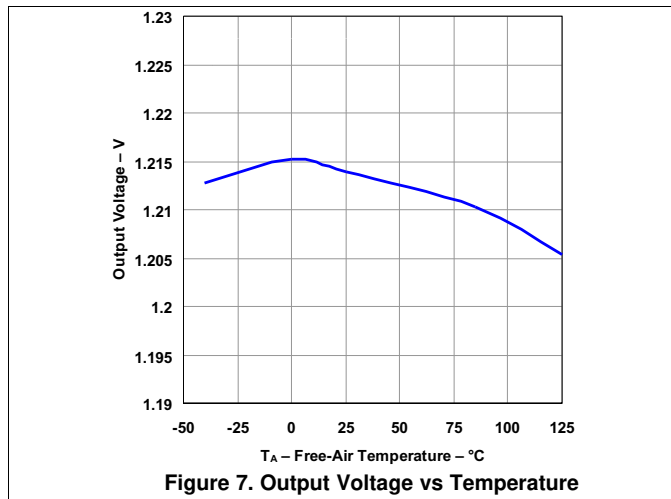

Figure 7. Output Voltage vs Temperature

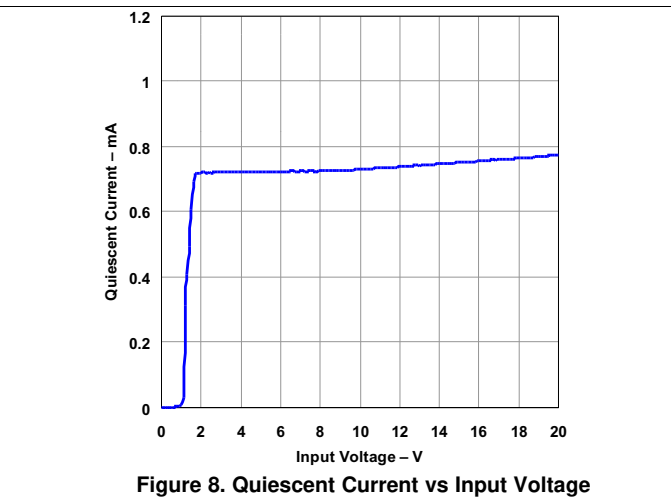

Figure 8. Quiescent Current vs Input Voltage

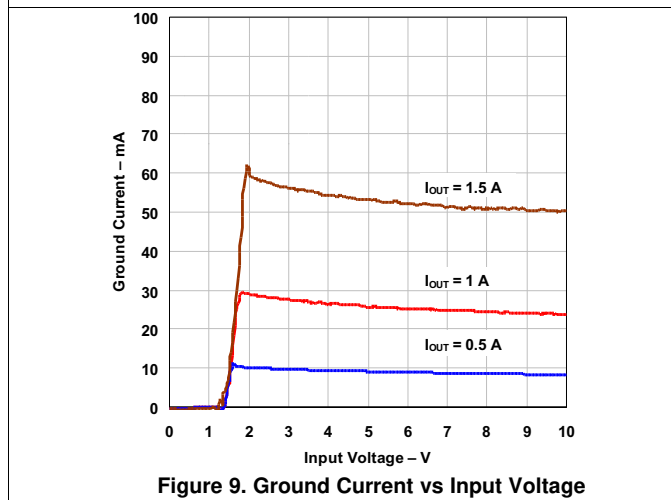

Figure 9. Ground Current vs Input Voltage

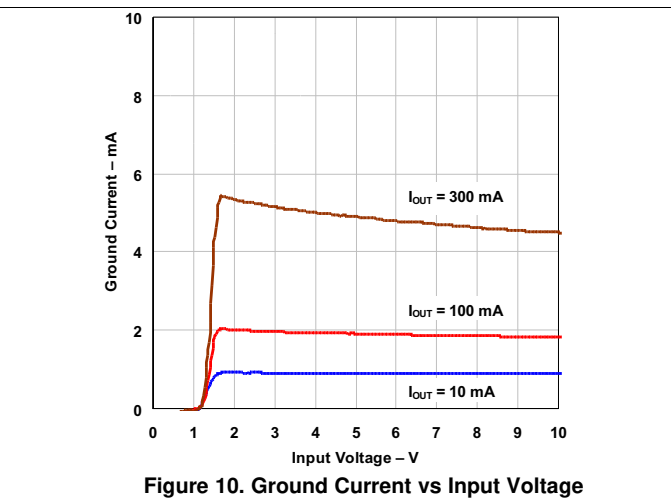

Figure 10. Ground Current vs Input Voltage

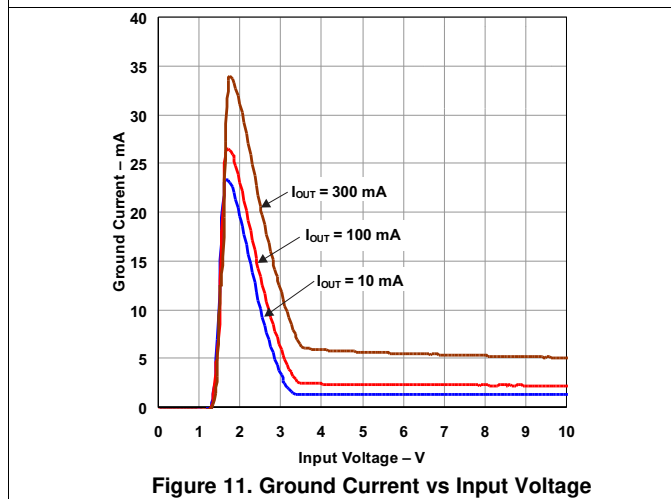

Figure 11. Ground Current vs Input Voltage

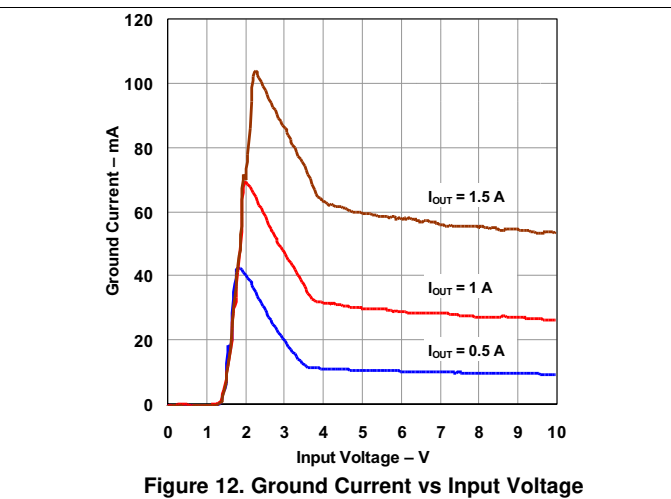

Figure 12. Ground Current vs Input Voltage

Typical Characteristics (continued)

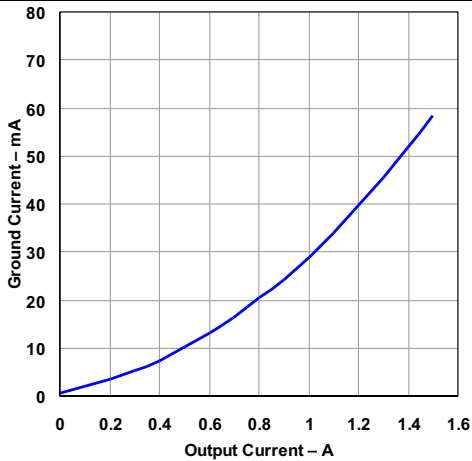

Figure 13. Ground Current vs Output Current

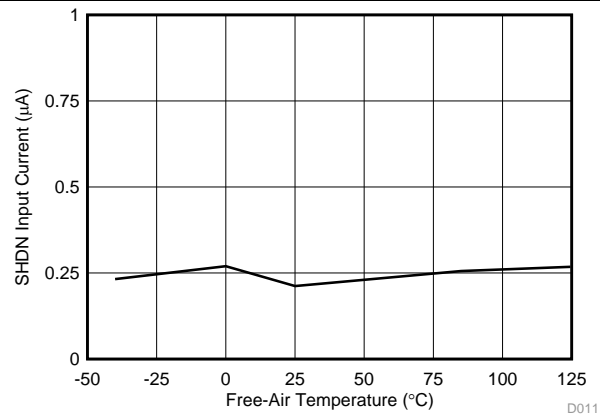

Figure 14. $\overline{\text{SHDN}}$ Input Current vs Temperature

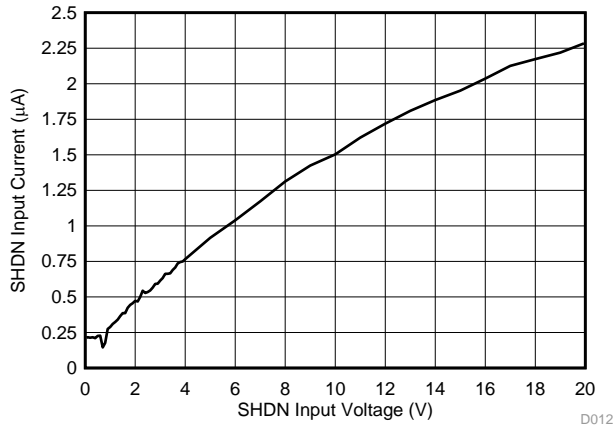

Figure 15. $\overline{\text{SHDN}}$ Input Current vs $\overline{\text{SHDN}}$ Input Voltage

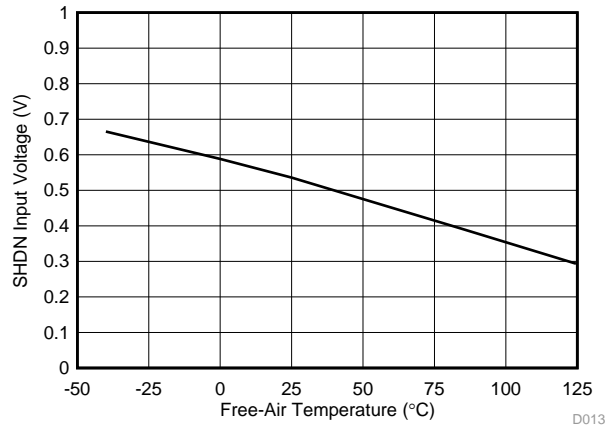

Figure 16. $\overline{\text{SHDN}}$ Threshold (OFF to ON) vs Temperature

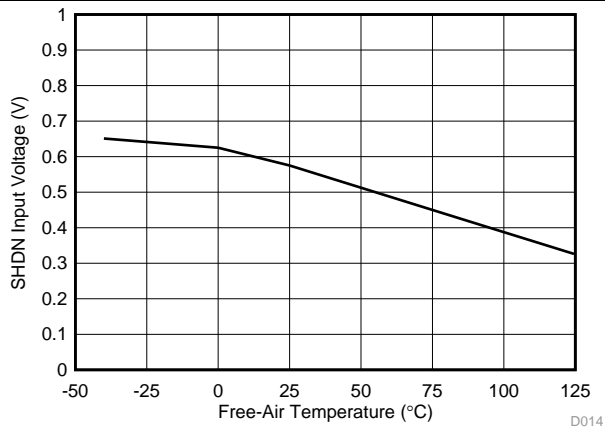

Figure 17. $\overline{\text{SHDN}}$ Threshold (ON to OFF) vs Temperature

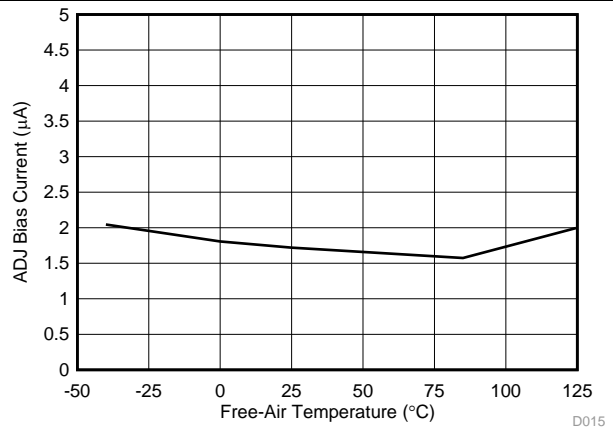
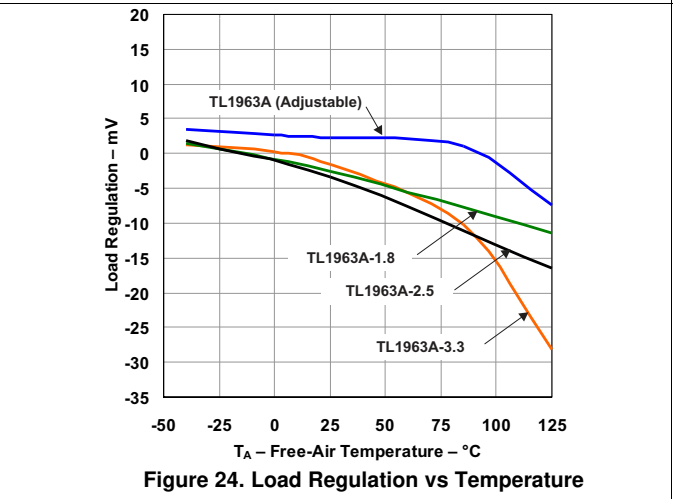
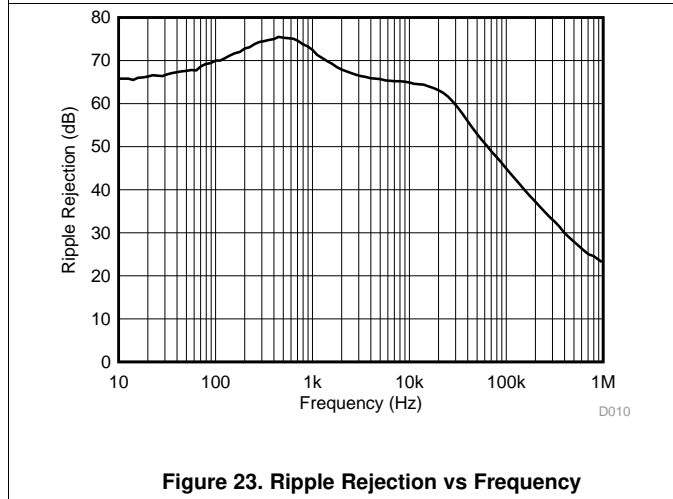
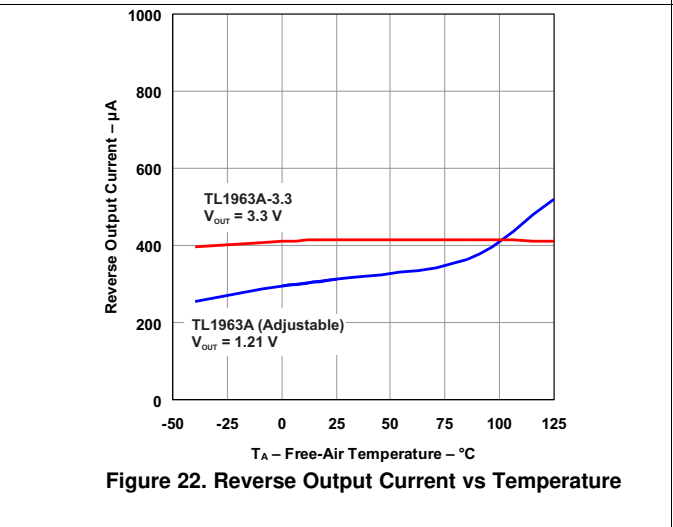
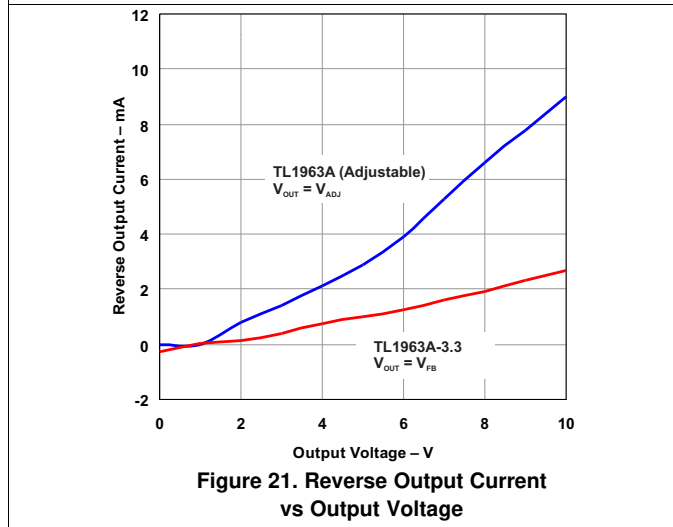
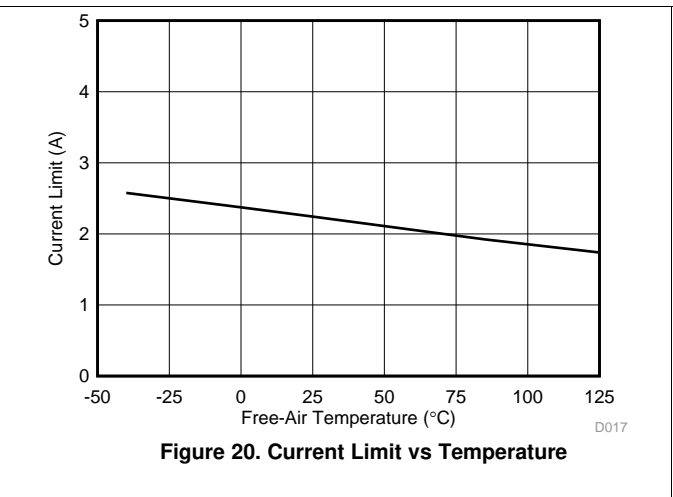
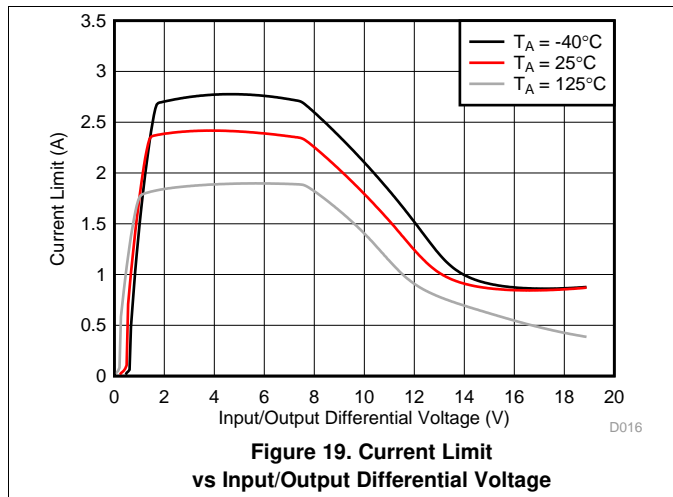

Figure 18. ADJ Bias Current vs Temperature

Typical Characteristics (continued)



Typical Characteristics (continued)

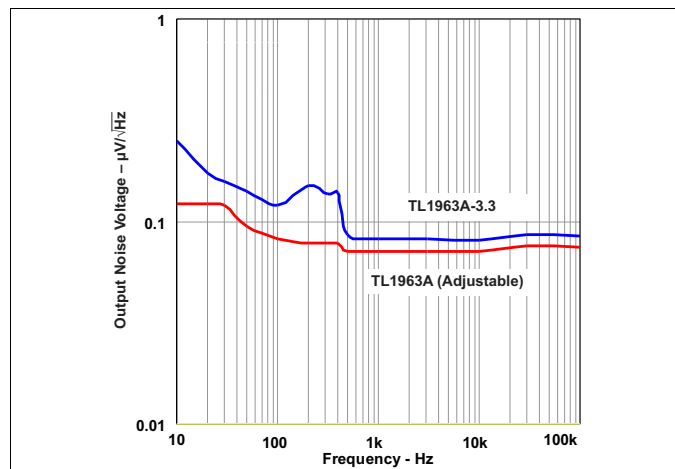

Figure 25. Output Noise Voltage vs Frequency

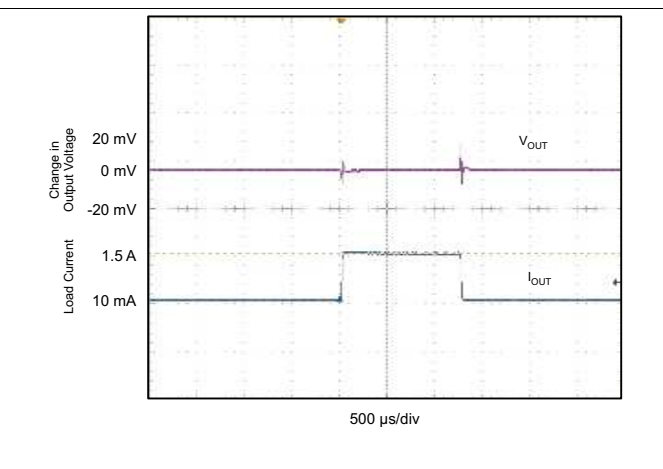

Figure 26. Load Transient Response

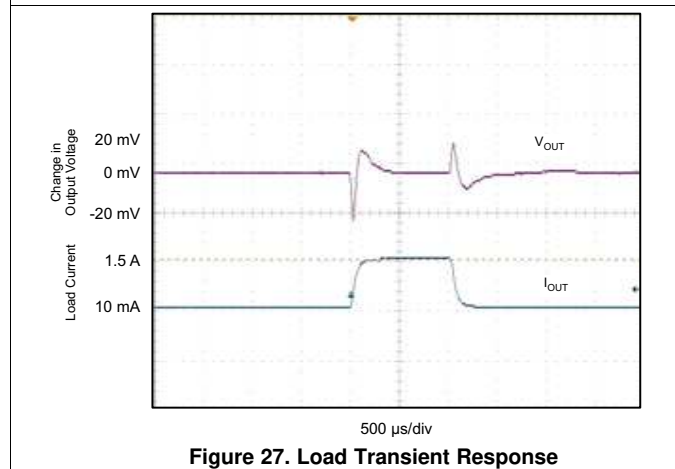

Figure 27. Load Transient Response

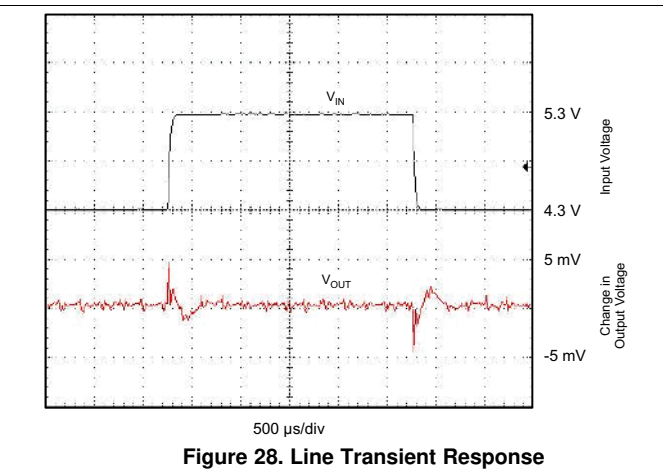

Figure 28. Line Transient Response

7 Detailed Description

7.1 Overview

The TL1963A-Q1 series are 1.5-A LDO regulators optimized for fast transient response. The devices are capable of supplying 1.5 A at a dropout voltage of 340 mV. The low operating quiescent current (1 mA) drops to less than 1 μ A in shutdown. In addition to the low quiescent current, the TL1963A-Q1 regulators incorporate several protection features which make them ideal for use in battery-powered systems. The devices are protected against both reverse input and reverse output voltages. In battery-backup applications where the output can be held up by a backup battery when the input is pulled to ground, the TL1963A-Q1 acts as if it has a diode in series with its output and prevents reverse current flow. Additionally, in dual-supply applications where the regulator load is returned to a negative supply, the output can be pulled below ground by as much as 20 V and still allow the device to start and operate.

7.2 Functional Block Diagram

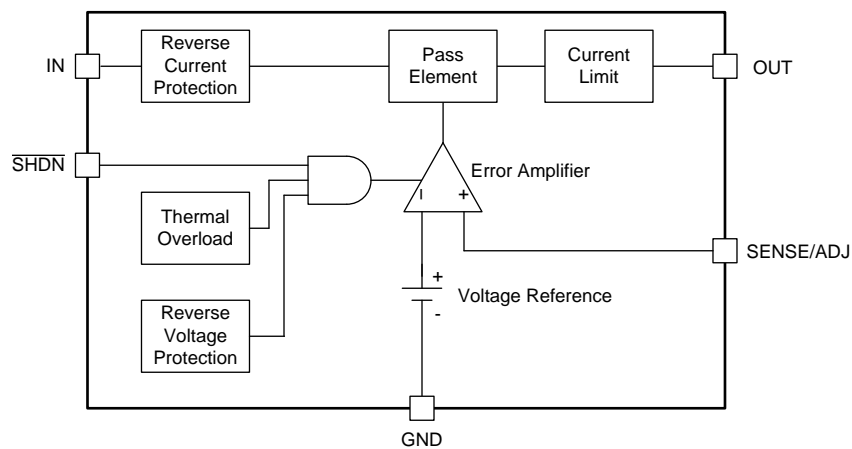

Copyright © 2016, Texas Instruments Incorporated

7.3 Feature Description

7.3.1 Adjustable Operation

The adjustable version of the TL1963A-Q1 has an output voltage range of 1.21 V to 20 V. The output voltage is set by the ratio of two external resistors as shown in Figure 29. The device maintains the voltage at the ADJ pin at 1.21 V referenced to ground. The current in R1 is then equal to 1.21 V / R1, and the current in R2 is the current in R1 plus the ADJ pin bias current. The ADJ pin bias current, 3 μ A at 25°C, flows through R2 into the ADJ pin. The output voltage can be calculated using the formula shown in Figure 29. The value of R1 must be less than 4.17 k Ω to minimize errors in the output voltage caused by the ADJ pin bias current. Note that in shutdown the output is turned off, and the divider current is zero.

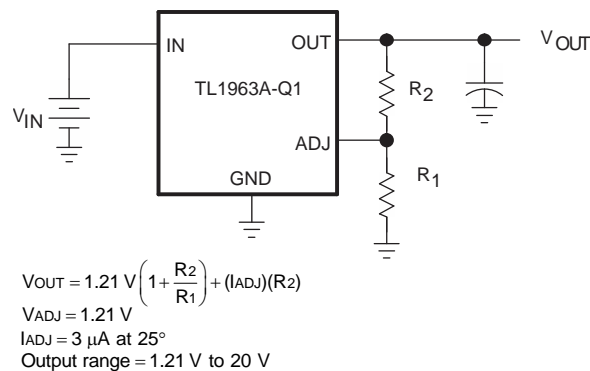

Figure 29. Adjustable Operation

Feature Description (continued)

The adjustable device is tested and specified with the ADJ pin tied to the OUT pin for an output voltage of 1.21 V. Specifications for output voltages greater than 1.21 V are proportional to the ratio of the desired output voltage to 1.21 V: $V_{OUT}/1.21\text{ V}$. For example, load regulation for an output current change of 1 mA to 1.5 A is –3 mV (typical) at $V_{OUT} = 1.21\text{ V}$. At $V_{OUT} = 5\text{ V}$, load regulation is calculated with [Equation 1](#).

$$(5\text{ V}/1.21\text{ V})(-3\text{ mV}) = -12.4\text{ mV} \quad (1)$$

7.3.2 Output Capacitance and Transient Response

The TL1963A-Q1 regulators are designed to be stable with a wide range of output capacitors. The ESR of the output capacitor affects stability, most notably with small capacitors. A minimum output capacitor of 10 μF with an ESR of 3 Ω or less is recommended to prevent oscillations. Larger values of output capacitance can decrease the peak deviations and provide improved transient response for larger load current changes. Bypass capacitors, used to decouple individual components powered by the TL1963A-Q1, increase the effective output capacitor value.

Carefully consider the use of ceramic capacitors. Ceramic capacitors are manufactured with a variety of dielectrics, each with different behavior over temperature and applied voltage. The most common dielectrics used are Z5U, Y5V, X5R, and X7R. The Z5U and Y5V dielectrics are good for providing high capacitances in a small package, but exhibit strong voltage and temperature coefficients. When used with a 5-V regulator, a 10- μF Y5V capacitor can exhibit an effective value as low as 1 μF to 2 μF over the operating temperature range. The X5R and X7R dielectrics result in more stable characteristics and are more suitable for use as the output capacitor. The X7R type has better stability across temperature, while the X5R is less expensive and is available in higher values.

Voltage and temperature coefficients are not the only sources of problems. Some ceramic capacitors have a piezoelectric response. A piezoelectric device generates voltage across its terminals due to mechanical stress, similar to the way a piezoelectric accelerometer or microphone works. For a ceramic capacitor the stress can be induced by vibrations in the system or thermal transients.

7.3.3 Overload Recovery

Like many IC power regulators, the TL1963A-Q1 has safe operating area protection. The safe area protection decreases the current limit as input-to-output voltage increases and keeps the power transistor inside a safe operating region for all values of input-to-output voltage. The protection is designed to provide some output current at all values of input-to-output voltage up to the device breakdown.

When power is first turned on, as the input voltage rises, the output follows the input, allowing the regulator to start up into very heavy loads. During start-up, as the input voltage is rising, the input-to-output voltage differential is small, allowing the regulator to supply large output currents. With a high input voltage, a problem can occur wherein removal of an output short does not allow the output voltage to recover. Other regulators also exhibit this phenomenon, so it is not unique to the TL1963A-Q1.

The problem occurs with a heavy output load when the input voltage is high and the output voltage is low. Common situations are immediately after the removal of a short circuit or when the shutdown pin is pulled high after the input voltage has already been turned on. The load line for such a load may intersect the output current curve at two points. If this happens, there are two stable output operating points for the regulator. With this double intersection, the input power supply may require cycling down to zero and being brought up again to make the output recover.

7.3.4 Output Voltage Noise

The TL1963A-Q1 regulators have been designed to provide low output voltage noise over the 10-Hz to 100-kHz bandwidth while operating at full load. Output voltage noise is typically 40 $\text{nV}/\sqrt{\text{Hz}}$ over this frequency bandwidth for the TL1963A-Q1 (adjustable version). For higher output voltages (generated by using a resistor divider), the output voltage noise is gained up accordingly. This results in RMS noise over the 10-Hz to 100-kHz bandwidth of 14 μV_{RMS} for the TL1963A-Q1, increasing to 38 μV_{RMS} for the TL1963A-Q1-3.3.

Exercise care with regards to circuit layout and testing to avoid measuring higher values of output voltage. Crosstalk from nearby traces can induce unwanted noise onto the output of the TL1963A-Q1. Power-supply ripple rejection must also be considered; the TL1963A-Q1 regulators do not have unlimited power-supply rejection and pass a small portion of the input noise through to the output.

Feature Description (continued)

7.3.5 Protection Features

The TL1963A-Q1 regulators incorporate several protection features that make them ideal for use in battery-powered circuits. In addition to the normal protection features associated with monolithic regulators, such as current limiting and thermal limiting, the devices are protected against reverse input voltages, reverse output voltages, and reverse voltages from output to input.

Current limit protection and thermal overload protection are intended to protect the device against current overload conditions at the output of the device. For normal operation, the junction temperature must not exceed 125°C.

The input of the device withstands reverse voltages of 20 V. Current flow into the device is limited to less than 1 mA (typically less than 100 μ A), and no negative voltage appears at the output. The device protects both itself and the load. This provides protection against batteries that can be plugged in backward.

The output of the TL1963A-Q1 can be pulled below ground without damaging the device. If the input is left open circuit or grounded, the output can be pulled below ground by 20 V. For fixed voltage versions, the output acts like a large resistor, typically 5 k Ω or higher, limiting current flow to typically less than 600 μ A. For adjustable versions, the output acts like an open circuit; no current flows out of the pin. If the input is powered by a voltage source, the output sources the short-circuit current of the device and protects itself by thermal limiting. In this case, grounding the SHDN pin turns off the device and stops the output from sourcing the short-circuit current.

The ADJ pin of the adjustable device can be pulled above or below ground by as much as 7 V without damaging the device. If the input is left open circuit or grounded, the ADJ pin acts like an open circuit when pulled below ground and like a large resistor (typically 5 k Ω) in series with a diode when pulled above ground.

In situations where the ADJ pin is connected to a resistor divider that would pull the ADJ pin above its 7-V clamp voltage if the output is pulled high, the ADJ pin input current must be limited to less than 5 mA. For example, a resistor divider is used to provide a regulated 1.5-V output from the 1.21-V reference when the output is forced to 20 V. The top resistor of the resistor divider must be chosen to limit the current into the ADJ pin to less than 5 mA when the ADJ pin is at 7 V. The 13-V difference between OUT and ADJ pins divided by the 5-mA maximum current into the ADJ pin yields a minimum top resistor value of 2.6 k Ω .

In circuits where a backup battery is required, several different input/output conditions can occur. The output voltage may be held up while the input is either pulled to ground, pulled to some intermediate voltage, or is left open circuit.

When the IN pin of the TL1963A-Q1 is forced below the OUT pin or the OUT pin is pulled above the IN pin, input current typically drops to less than 2 μ A. This can happen if the input of the device is connected to a discharged (low voltage) battery and the output is held up by either a backup battery or a second regulator circuit. The state of the SHDN pin has no effect on the reverse output current when the output is pulled above the input.

7.4 Device Functional Modes

Table 1 lists the device states of TL1963A-Q1.

Table 1. Device States

SHDN	DEVICE STATE
H	Regulated voltage
L	Shutdown

8 Application and Implementation

NOTE

Information in the following applications sections is not part of the TI component specification, and TI does not warrant its accuracy or completeness. TI's customers are responsible for determining suitability of components for their purposes. Customers should validate and test their design implementation to confirm system functionality.

8.1 Application Information

This section highlights some of the design considerations when implementing this device in various applications.

8.1.1 Output Capacitance and Transient Response

The TL1963A-Q1 regulators are designed to be stable with a wide range of output capacitors. The ESR of the output capacitor affects stability, most notably with small capacitors. A minimum output capacitor of 10 μF with an ESR of 3 Ω or less is recommended to prevent oscillations. Larger values of output capacitance can decrease the peak deviations and provide improved transient response for larger load current changes. Bypass capacitors, used to decouple individual components powered by the TL1963A-Q1, increase the effective output capacitor value.

Carefully consider the use of ceramic capacitors. Ceramic capacitors are manufactured with a variety of dielectrics, each with different behavior over temperature and applied voltage. The most common dielectrics used are Z5U, Y5V, X5R, and X7R. The Z5U and Y5V dielectrics are good for providing high capacitances in a small package, but exhibit strong voltage and temperature coefficients. When used with a 5-V regulator, a 10- μF Y5V capacitor can exhibit an effective value as low as 1 μF to 2 μF over the operating temperature range. The X5R and X7R dielectrics result in more stable characteristics and are more suitable for use as the output capacitor. The X7R type has better stability across temperature, while the X5R is less expensive and is available in higher values.

Voltage and temperature coefficients are not the only sources of problems. Some ceramic capacitors have a piezoelectric response. A piezoelectric device generates voltage across its terminals due to mechanical stress, similar to the way a piezoelectric accelerometer or microphone works. For a ceramic capacitor, the stress can be induced by vibrations in the system or thermal transients.

8.2 Typical Application

8.2.1 Adjustable Output Operation

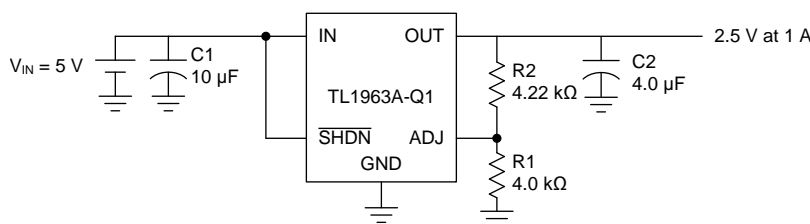

Copyright © 2016, Texas Instruments Incorporated

All capacitors are ceramic

Figure 30. Adjustable Output Voltage Schematic

Typical Application (continued)

8.2.1.1 Design Requirements

Table 2 lists the design requirements for this application example.

Table 2. Example Parameters

PARAMETER	VALUE
Input voltage (V_{IN})	5 V
Output voltage (V_{OUT})	2.5 V
Output current (I_{OUT})	0 A to 1 A
Load regulation	1%

8.2.1.2 Detailed Design Procedure

The TL1963A-Q1 has an adjustable output voltage range of 1.21 V to 20 V. The output voltage is set by the ratio of two external resistors R1 and R2 as shown in Figure 30. The device maintains the voltage at the ADJ pin at 1.21 V referenced to ground. The current in R1 is then equal to $(1.21 \text{ V}/R1)$, and the current in R2 is the current in R1 plus the ADJ pin bias current. The ADJ pin bias current, 3 μA at 25°C, flows through R2 into the ADJ pin. The output voltage can be calculated using Equation 2.

$$V_{OUT} = 1.21 \text{ V} \left(1 + \frac{R2}{R1} \right) + I_{ADJ} \times R2 \quad (2)$$

The value of R1 must be less than 4.17 k Ω to minimize errors in the output voltage caused by the ADJ pin bias current. Note that in shutdown the output is turned off, and the divider current is zero. For an output voltage of 2.5 V, R1 is set to 4 k Ω . R2 is then found to be 4.22 k Ω using the equation above in Equation 3.

$$V_{OUT} = 1.21 \text{ V} \left(1 + \frac{4.22 \text{ k}\Omega}{4.0 \text{ k}\Omega} \right) + 3 \mu\text{A} \times 4.22 \text{ k}\Omega$$

where

$$\bullet V_{OUT} = 2.5 \text{ V} \quad (3)$$

The adjustable device is tested and specified with the ADJ pin tied to the OUT pin for an output voltage of 1.21 V. Specifications for output voltages greater than 1.21 V are proportional to the ratio of the desired output voltage to 1.21 V = $V_{OUT}/1.21 \text{ V}$. For example, load regulation for an output current change of 1 mA to 1.5 A is –2 mV (typical) at $V_{OUT} = 1.21 \text{ V}$. At $V_{OUT} = 2.5 \text{ V}$, the typical load regulation is calculated with Equation 4.

$$(2.50 \text{ V} / 1.21 \text{ V})(-2 \text{ mV}) = -4.13 \text{ mV} \quad (4)$$

Figure 33 shows the actual change in output is approximately 3 mV for a 1-A load step. The maximum load regulation at 25°C is –8 mV. At $V_{OUT} = 2.5 \text{ V}$, the maximum load regulation is calculated with Equation 5.

$$(2.50 \text{ V} / 1.21 \text{ V})(-8 \text{ mV}) = -16.53 \text{ mV} \quad (5)$$

Because 16.53 mV is only 0.7% of the 2.5-V output voltage, the load regulation meets the design requirements.

8.2.1.2.1 Fixed Operation

The TL1963A-Q1 can be used in a fixed voltage configuration. The SENSE/ADJ pin must be connected to OUT for proper operation. An example of this is shown in Figure 31. The TL1963A-Q1 can also be used in this configuration for a fixed output voltage of 2.5 V.

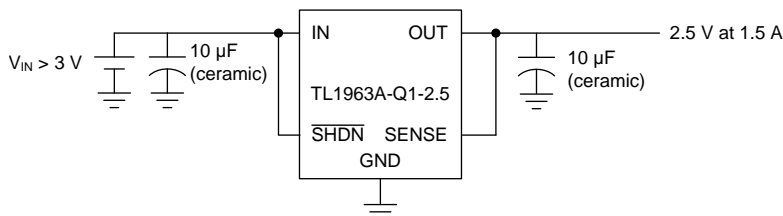

Copyright © 2016, Texas Instruments Incorporated

Figure 31. 3.3-V to 2.5-V Regulator

During fixed voltage operation, the SENSE/ADJ pin can be used for a Kelvin connection if routed separately to the load (see Figure 32). This allows the regulator to compensate for voltage drop across parasitic resistances (R_P) between the output and the load. This becomes more crucial with higher load currents.

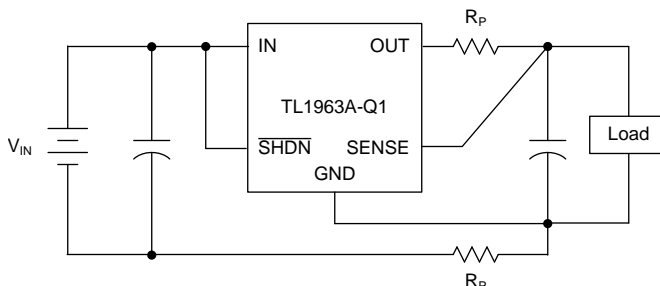

Copyright © 2016, Texas Instruments Incorporated

Figure 32. Kelvin Sense Connection

8.2.1.3 Application Curve

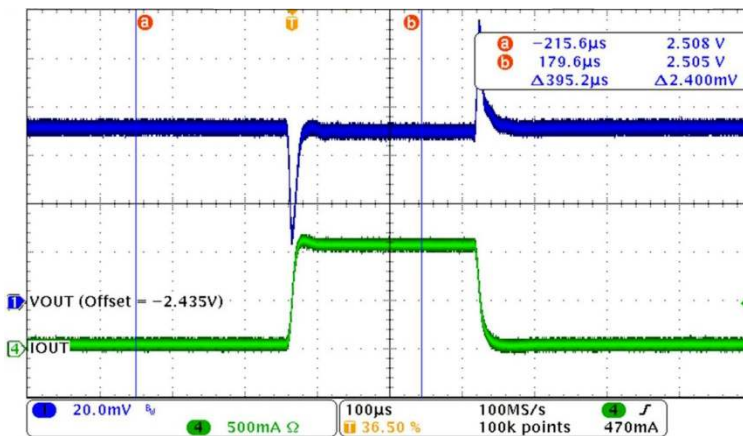
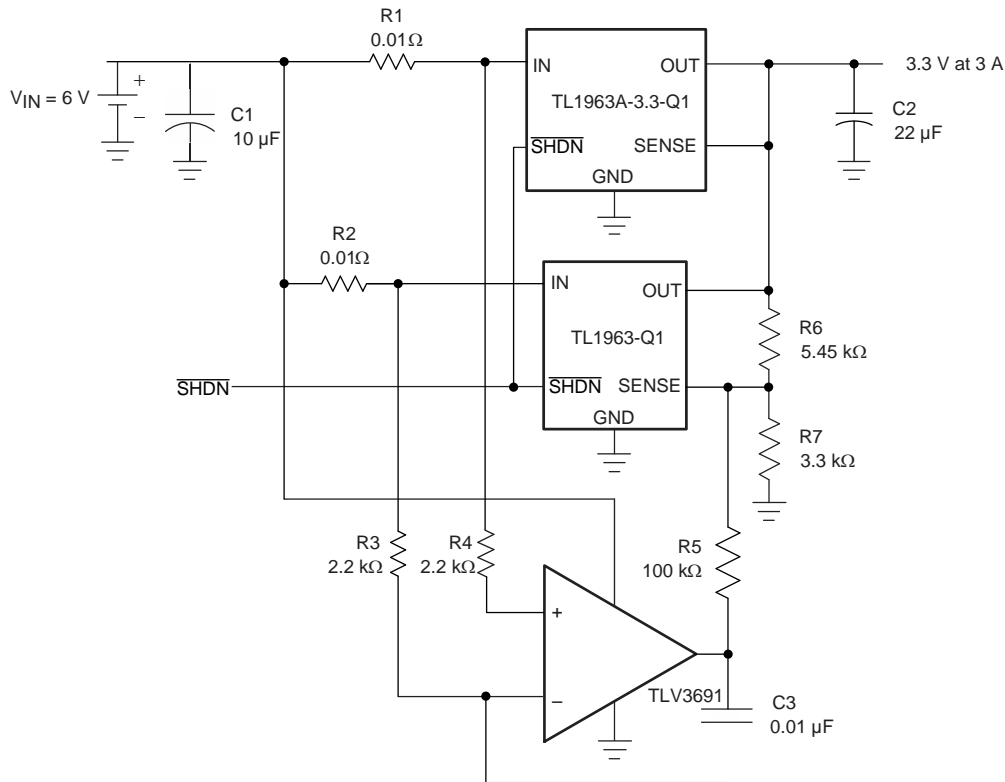

Figure 33. 1-A Load Transient Response (C_{OUT} = 10 µF)

8.2.2 Paralleling Regulators for Higher Output Current



Copyright © 2016, Texas Instruments Incorporated

All capacitors are ceramic

Figure 34. Paralleling Regulator Schematic

8.2.2.1 Design Requirements

Table 3 lists the design requirements for this application example.

Table 3. Example Parameters

PARAMETER	VALUE
Input voltage (V_{IN})	6 V
Output voltage (V_{OUT})	3.3 V
Output current (I_{OUT})	3 A

8.2.2.2 Detailed Design Procedure

In an application requiring higher output current, an adjustable output regular can be placed in parallel with a fixed output regulator to increase the current capacity. Two sense resistors and a comparator can be used to control the feedback loop of the adjustable regulator to balance the current between the two regulators.

In Figure 34, resistors R1 and R2 are used to sense the current flowing into each regulator and must have a very low resistance to avoid unnecessary power loss. R1 and R2 must have the same value and a tolerance of 1% or better so the current is shared equally between the regulators. For this example, a value of 0.01 Ω is used.

The TLV3691 rail-to-rail nanopower comparator output alternates between VIN and GND depending on the currents flowing into each of the two regulators. To design this control circuit, begin by looking at the case where the two output currents are approximately equal and the comparator output is low. In this case, the output of the TL1963A-Q1 must be set the same as the fixed voltage regulator. The TL1963A-Q1-3.3 has a 3.3-V fixed output, so this is the set point for the adjustable regulator. Begin by selecting a R7 value less than 4.17 kΩ. In this example, 3.3 kΩ is used. R5 requires a high resistance to satisfy Equation 9, for this example 100-kΩ is chosen. Then find the parallel resistance of R5 and R7 because they are both connected from the ADJ pin to GND using Equation 6.

$$(R5||R7) = \frac{R5 \times R7}{R5 + R7} = 3.19 \text{ k}\Omega \tag{6}$$

Once the R5 and R7 parallel resistance is calculated, the value for R6 are found using Equation 7.

$$R6 = \frac{V_{OUT}}{1.22 \text{ V}} (R5||R7) - (R5||R7) \tag{7}$$

$$R6 = \frac{3.3 \text{ V}}{1.22 \text{ V}} (3.19 \text{ k}\Omega) - (3.19 \text{ k}\Omega)$$

where

- R6 = 5.45 kΩ (8)

In the case where the TL1963A-Q1-3.3 is sourcing more current than TL1963A-Q1, the comparator output goes high.

This lowers the voltage at the ADJ pin causing the TL1963A-Q1 to try and raise the output voltage by sourcing more current. The TL1963A-Q1-3.3 then reacts by sourcing less current to try and keep the output from rising.

When the current through the TL1963A-Q1-3.3 becomes less than the TL1963A-Q1, the comparator output returns to GND. In order for this to happen, Equation 9 must be satisfied.

$$V_{IN} \left(\frac{R7}{R5 + R7} \right) + (V_{IN} - V_{OUT}) \left(\frac{R6}{R5 + R6} \right) < V_{ref} \tag{9}$$

$$6\text{V} \left(\frac{3.3 \text{ k}\Omega}{100 \text{ k}\Omega + 3.3 \text{ k}\Omega} \right) + (2.7 \text{ V}) \left(\frac{5.45 \text{ k}\Omega}{100 \text{ k}\Omega + 5.45 \text{ k}\Omega} \right) < 1.21 \text{ V}$$

where

- 0.33 V < 1.21 V (10)

8.2.2.3 Application Curve

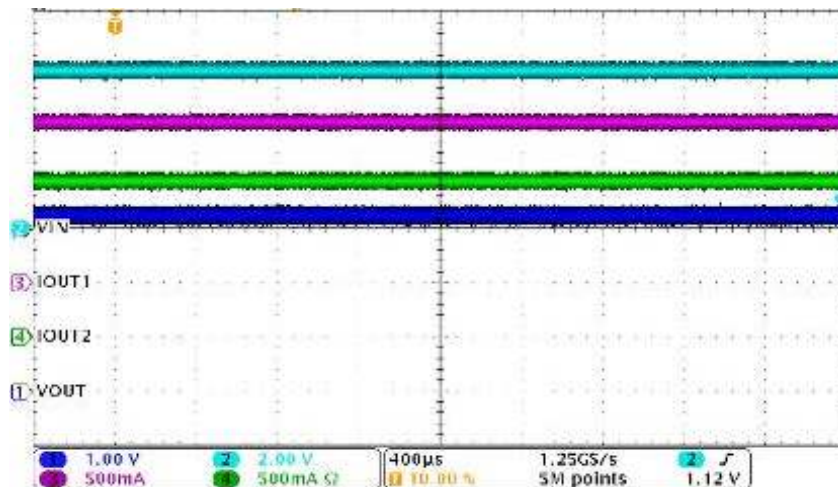

Figure 35. Parallel Regulators Sharing Load Current

9 Power Supply Recommendations

The power handling capability of the device is limited by the maximum rated junction temperature (125°C). The power dissipated by the device is made up of two components:

1. Output current multiplied by the input and output voltage differential: $I_{OUT}(V_{IN} - V_{OUT})$.
2. GND pin current multiplied by the input voltage: $I_{GND}V_{IN}$.

The GND pin current can be found using the GND Pin Current graphs in [Typical Characteristics](#). Power dissipation is equal to the sum of the two components listed above.

The TL1963A-Q1 series regulators have internal thermal limiting designed to protect the device during overload conditions. For continuous normal conditions, the maximum junction temperature rating of 125°C must not be exceeded. It is important to carefully consider all sources of thermal resistance from junction to ambient. Additional heat sources mounted nearby must also be considered.

For surface-mount devices, heat sinking is accomplished by using the heat-spreading capabilities of the PCB and its copper traces. Copper board stiffeners and plated through-holes also can be used to spread the heat generated by power devices.

[Table 4](#) lists thermal resistance for several different board sizes and copper areas. All measurements were taken in still air on 1/16-inch FR-4 board with one-ounce copper.

Table 4. KTT Package (5-Pin TO-263)

COPPER AREA		BOARD AREA	THERMAL RESISTANCE (JUNCTION TO AMBIENT)
TOPSIDE ⁽¹⁾	BACKSIDE		
2500 mm ²	2500 mm ²	2500 mm ²	23°C/W
1000 mm ²	2500 mm ²	2500 mm ²	25°C/W
125 mm ²	2500 mm ²	2500 mm ²	33°C/W

(1) Device is mounted on topside.

10 Layout

10.1 Layout Guidelines

For best performance, follow the guidelines below:

- All traces must be as short as possible.
- Use wide traces for IN, OUT, and GND to minimize the parasitic electrical effects.
- A minimum output capacitor of 10 μF with an ESR of 3 Ω or less is recommended to prevent oscillations. X5R and X7R dielectrics are preferred.
- Place the output capacitor as close as possible to the OUT pin of the device.
- The exposed thermal pad of the KTT package must be connected to a wide ground plane for effective heat dissipation.

10.2 Layout Example

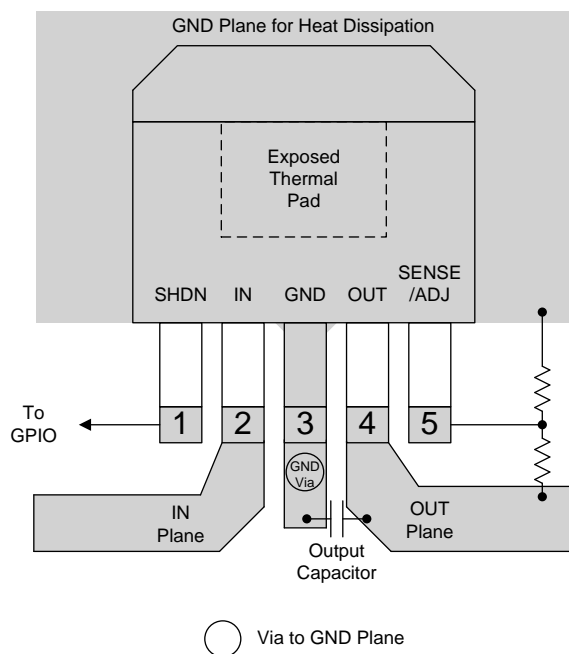

Copyright © 2016, Texas Instruments Incorporated

Figure 36. TO-263 (KTT) Layout Example

10.3 Calculating Junction Temperature

Given an output voltage of 3.3 V, an input voltage range of 4 V to 6 V, an output current range of 0 mA to 500 mA, and a maximum ambient temperature of 50°C, what is the maximum junction temperature?

The power dissipated by the device is equal to Equation 11.

$$I_{OUT(MAX)}(V_{IN(MAX)} - V_{OUT}) + I_{GND}(V_{IN(MAX)})$$

where

- $I_{OUT(MAX)} = 500 \text{ mA}$
- $V_{IN(MAX)} = 6 \text{ V}$
- I_{GND} at ($I_{OUT} = 500 \text{ mA}$, $V_{IN} = 6 \text{ V}$) = 10 mA

(11)

So, $P = 500 \text{ mA} (6 \text{ V} - 3.3 \text{ V}) + 10 \text{ mA} (6 \text{ V}) = 1.41 \text{ W}$.

Using a KTT package, the thermal resistance is in the range of 23°C/W to 33°C/W, depending on the copper area. So the junction temperature rise above ambient is approximately equal to Equation 12.

$$1.41 \text{ W} \times 28^\circ\text{C/W} = 39.5^\circ\text{C}$$

(12)

The maximum junction temperature is then be equal to the maximum junction-temperature rise above ambient plus the maximum ambient temperature or Equation 13.

$$T_{JMAX} = 50^\circ\text{C} + 39.5^\circ\text{C} = 89.5^\circ\text{C}$$

(13)

11 Device and Documentation Support

11.1 Receiving Notification of Documentation Updates

To receive notification of documentation updates, navigate to the device product folder on ti.com. In the upper right corner, click on *Alert me* to register and receive a weekly digest of any product information that has changed. For change details, review the revision history included in any revised document.

11.2 Community Resources

The following links connect to TI community resources. Linked contents are provided "AS IS" by the respective contributors. They do not constitute TI specifications and do not necessarily reflect TI's views; see TI's [Terms of Use](#).

TI E2E™ Online Community *TI's Engineer-to-Engineer (E2E) Community*. Created to foster collaboration among engineers. At e2e.ti.com, you can ask questions, share knowledge, explore ideas and help solve problems with fellow engineers.

Design Support *TI's Design Support* Quickly find helpful E2E forums along with design support tools and contact information for technical support.

11.3 Trademarks

E2E is a trademark of Texas Instruments.
All other trademarks are the property of their respective owners.

11.4 Electrostatic Discharge Caution



These devices have limited built-in ESD protection. The leads should be shorted together or the device placed in conductive foam during storage or handling to prevent electrostatic damage to the MOS gates.

11.5 Glossary

[SLYZ022](#) — *TI Glossary*.

This glossary lists and explains terms, acronyms, and definitions.

12 Mechanical, Packaging, and Orderable Information

The following pages include mechanical, packaging, and orderable information. This information is the most current data available for the designated devices. This data is subject to change without notice and revision of this document. For browser-based versions of this data sheet, refer to the left-hand navigation.

PACKAGING INFORMATION

Orderable Device	Status (1)	Package Type	Package Drawing	Pins	Package Qty	Eco Plan (2)	Lead finish/ Ball material (6)	MSL Peak Temp (3)	Op Temp (°C)	Device Marking (4/5)	Samples
TL1963AQKTRQ1	ACTIVE	DDPAK/ TO-263	KTT	5	500	RoHS & Green	SN	Level-3-245C-168 HR	-40 to 125	TL1963AQ	Samples

(1) The marketing status values are defined as follows:

ACTIVE: Product device recommended for new designs.

LIFEBUY: TI has announced that the device will be discontinued, and a lifetime-buy period is in effect.

NRND: Not recommended for new designs. Device is in production to support existing customers, but TI does not recommend using this part in a new design.

PREVIEW: Device has been announced but is not in production. Samples may or may not be available.

OBSOLETE: TI has discontinued the production of the device.

(2) **RoHS:** TI defines "RoHS" to mean semiconductor products that are compliant with the current EU RoHS requirements for all 10 RoHS substances, including the requirement that RoHS substance do not exceed 0.1% by weight in homogeneous materials. Where designed to be soldered at high temperatures, "RoHS" products are suitable for use in specified lead-free processes. TI may reference these types of products as "Pb-Free".

RoHS Exempt: TI defines "RoHS Exempt" to mean products that contain lead but are compliant with EU RoHS pursuant to a specific EU RoHS exemption.

Green: TI defines "Green" to mean the content of Chlorine (Cl) and Bromine (Br) based flame retardants meet JS709B low halogen requirements of <=100ppm threshold. Antimony trioxide based flame retardants must also meet the <=1000ppm threshold requirement.

(3) MSL, Peak Temp. - The Moisture Sensitivity Level rating according to the JEDEC industry standard classifications, and peak solder temperature.

(4) There may be additional marking, which relates to the logo, the lot trace code information, or the environmental category on the device.

(5) Multiple Device Markings will be inside parentheses. Only one Device Marking contained in parentheses and separated by a "~" will appear on a device. If a line is indented then it is a continuation of the previous line and the two combined represent the entire Device Marking for that device.

(6) Lead finish/Ball material - Orderable Devices may have multiple material finish options. Finish options are separated by a vertical ruled line. Lead finish/Ball material values may wrap to two lines if the finish value exceeds the maximum column width.

Important Information and Disclaimer:The information provided on this page represents TI's knowledge and belief as of the date that it is provided. TI bases its knowledge and belief on information provided by third parties, and makes no representation or warranty as to the accuracy of such information. Efforts are underway to better integrate information from third parties. TI has taken and continues to take reasonable steps to provide representative and accurate information but may not have conducted destructive testing or chemical analysis on incoming materials and chemicals. TI and TI suppliers consider certain information to be proprietary, and thus CAS numbers and other limited information may not be available for release.

In no event shall TI's liability arising out of such information exceed the total purchase price of the TI part(s) at issue in this document sold by TI to Customer on an annual basis.

OTHER QUALIFIED VERSIONS OF TL1963A-Q1 :

- Catalog: [TL1963A](#)

NOTE: Qualified Version Definitions:

- Catalog - TI's standard catalog product

TAPE AND REEL INFORMATION

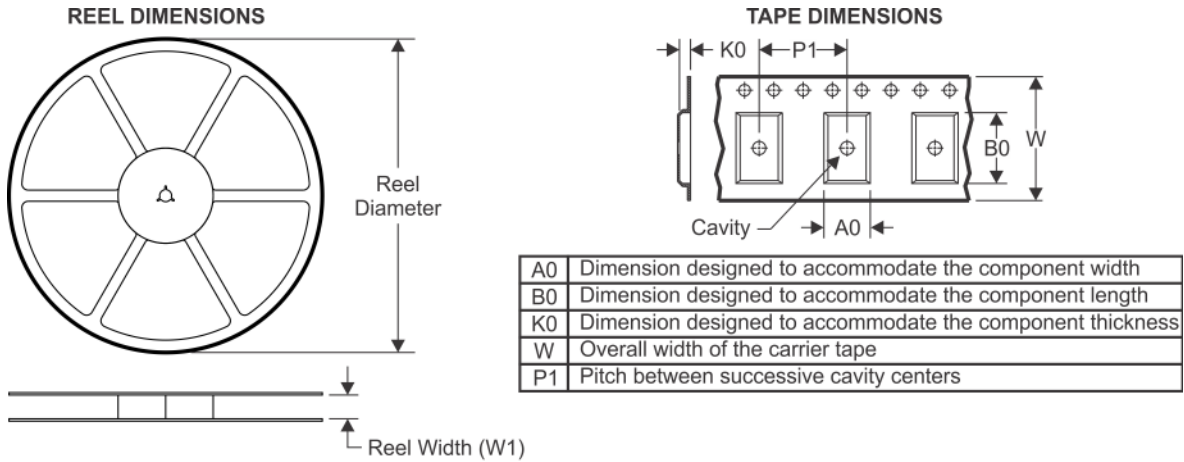

QUADRANT ASSIGNMENTS FOR PIN 1 ORIENTATION IN TAPE

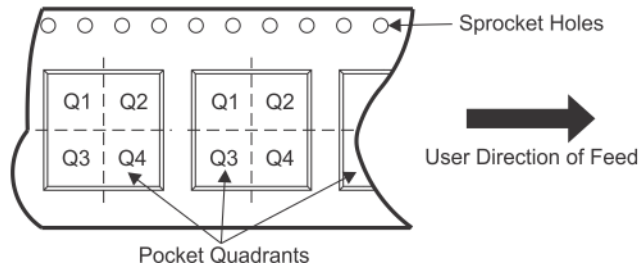

*All dimensions are nominal

Device	Package Type	Package Drawing	Pins	SPQ	Reel Diameter (mm)	Reel Width W1 (mm)	A0 (mm)	B0 (mm)	K0 (mm)	P1 (mm)	W (mm)	Pin1 Quadrant
TL1963AQKTTRQ1	DDPAK/TO-263	KTT	5	500	330.0	24.4	10.6	15.8	4.9	16.0	24.0	Q2

TAPE AND REEL BOX DIMENSIONS



*All dimensions are nominal

Device	Package Type	Package Drawing	Pins	SPQ	Length (mm)	Width (mm)	Height (mm)
TL1963AQKTTRQ1	DDPAK/TO-263	KTT	5	500	340.0	340.0	38.0

KTT (R-PSFM-G5)

PLASTIC FLANGE-MOUNT PACKAGE

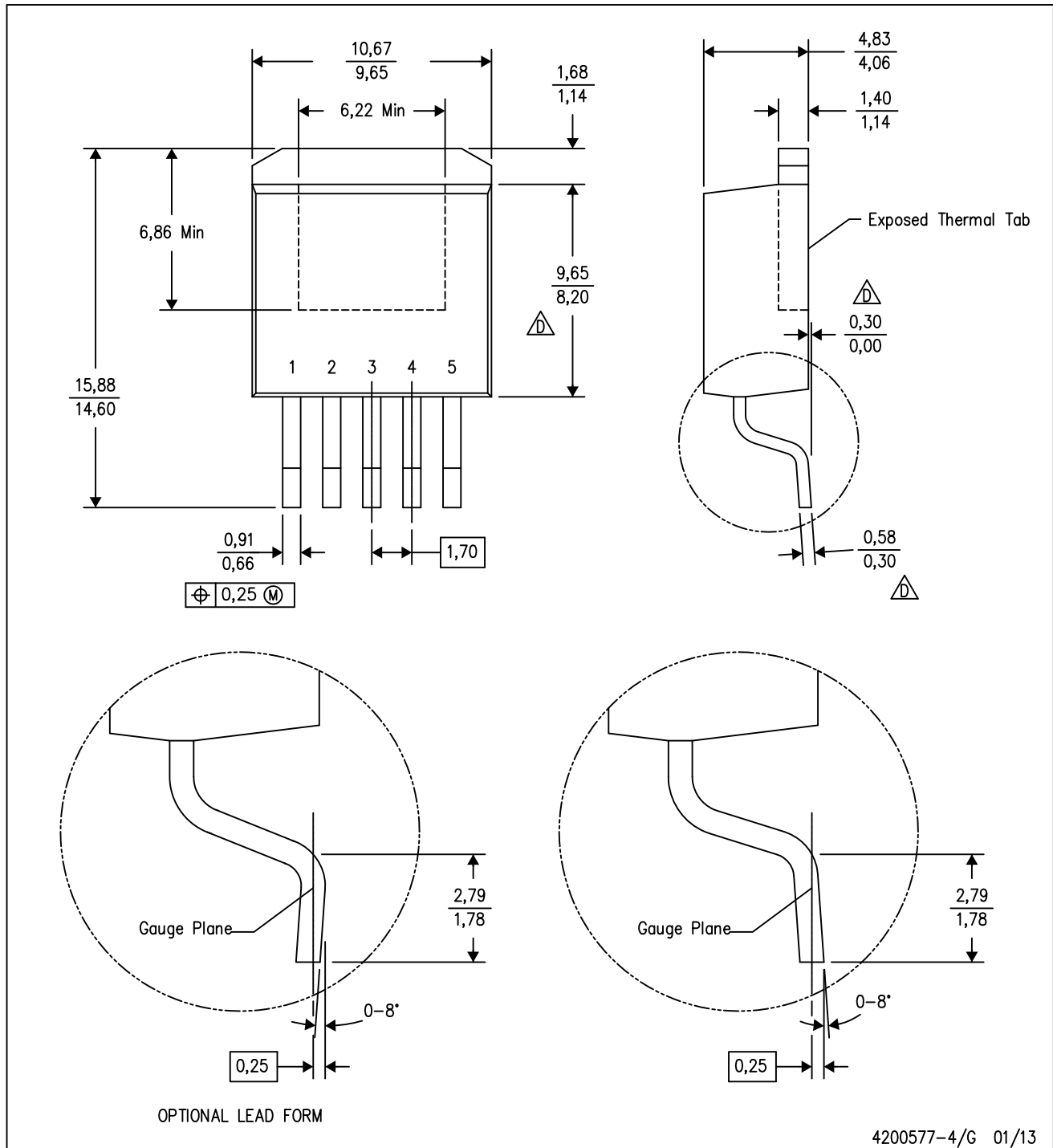

- NOTES:
- A. All linear dimensions are in millimeters.
 - B. This drawing is subject to change without notice.
 - C. Body dimensions do not include mold flash or protrusion. Mold flash or protrusion not to exceed 0.005 (0,13) per side.
- △ Falls within JEDEC TO-263 variation BA, except minimum lead thickness, maximum seating height, and minimum body length.

KTT (R-PSFM-G5)

PLASTIC FLANGE-MOUNT PACKAGE

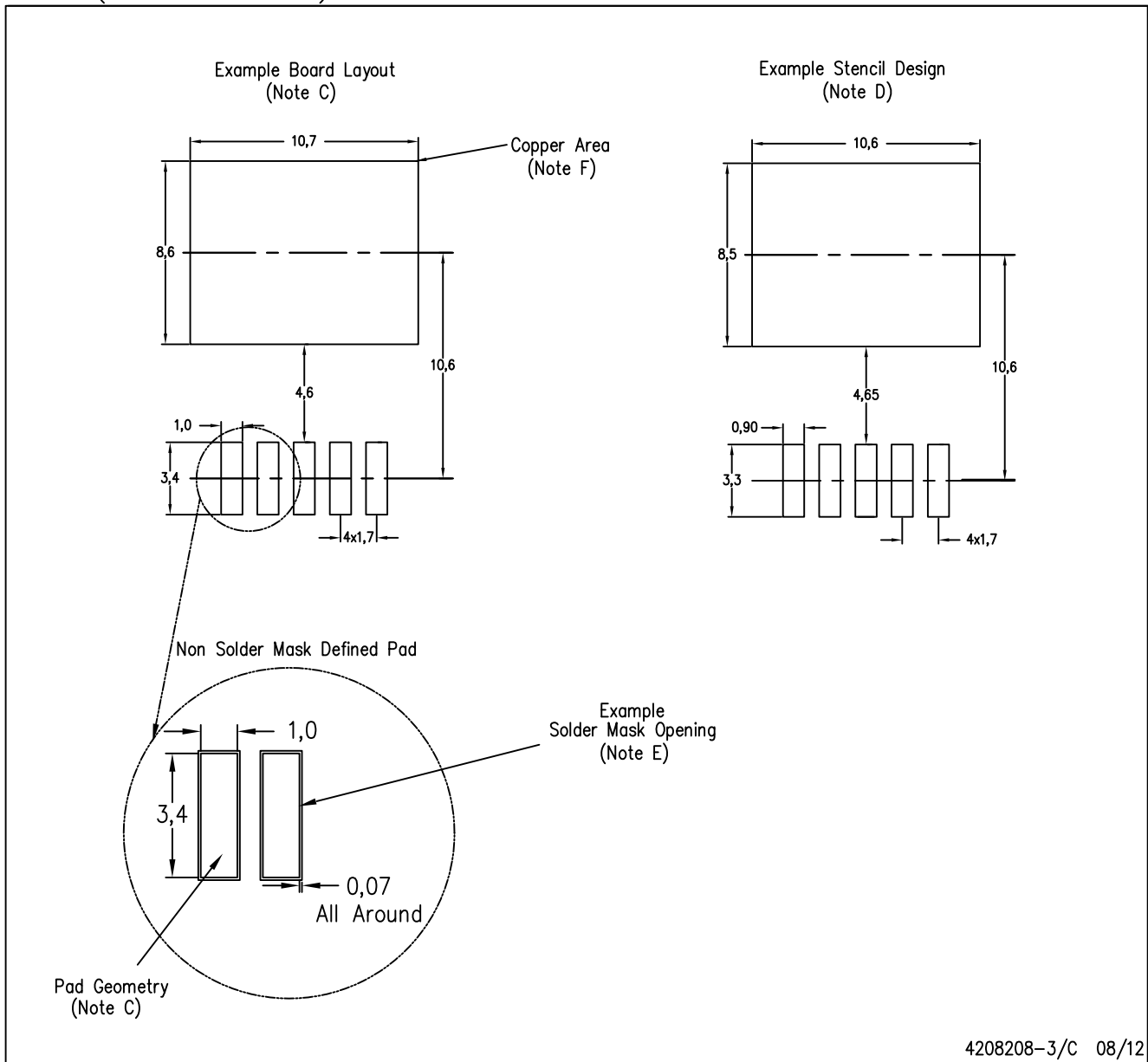

- NOTES:
- All linear dimensions are in millimeters.
 - This drawing is subject to change without notice.
 - Publication IPC-SM-782 is recommended for alternate designs.
 - Laser cutting apertures with trapezoidal walls and also rounding corners will offer better paste release. Customers should contact their board assembly site for stencil design recommendations. Refer to IPC-7525.
 - Customers should contact their board fabrication site for solder mask tolerances between and around signal pads.
 - This package is designed to be soldered to a thermal pad on the board. Refer to the Product Datasheet for specific thermal information, via requirements, and recommended thermal pad size. For thermal pad sizes larger than shown a solder mask defined pad is recommended in order to maintain the solderable pad geometry while increasing copper area.

IMPORTANT NOTICE AND DISCLAIMER

TI PROVIDES TECHNICAL AND RELIABILITY DATA (INCLUDING DATASHEETS), DESIGN RESOURCES (INCLUDING REFERENCE DESIGNS), APPLICATION OR OTHER DESIGN ADVICE, WEB TOOLS, SAFETY INFORMATION, AND OTHER RESOURCES "AS IS" AND WITH ALL FAULTS, AND DISCLAIMS ALL WARRANTIES, EXPRESS AND IMPLIED, INCLUDING WITHOUT LIMITATION ANY IMPLIED WARRANTIES OF MERCHANTABILITY, FITNESS FOR A PARTICULAR PURPOSE OR NON-INFRINGEMENT OF THIRD PARTY INTELLECTUAL PROPERTY RIGHTS.

These resources are intended for skilled developers designing with TI products. You are solely responsible for (1) selecting the appropriate TI products for your application, (2) designing, validating and testing your application, and (3) ensuring your application meets applicable standards, and any other safety, security, or other requirements. These resources are subject to change without notice. TI grants you permission to use these resources only for development of an application that uses the TI products described in the resource. Other reproduction and display of these resources is prohibited. No license is granted to any other TI intellectual property right or to any third party intellectual property right. TI disclaims responsibility for, and you will fully indemnify TI and its representatives against, any claims, damages, costs, losses, and liabilities arising out of your use of these resources.

TI's products are provided subject to TI's Terms of Sale (www.ti.com/legal/termsofsale.html) or other applicable terms available either on ti.com or provided in conjunction with such TI products. TI's provision of these resources does not expand or otherwise alter TI's applicable warranties or warranty disclaimers for TI products.

Mailing Address: Texas Instruments, Post Office Box 655303, Dallas, Texas 75265
Copyright © 2020, Texas Instruments Incorporated