

NOTES:

- MATERIALS:**
HOUSING - LCP, 30% GLASS FILLED, 94-VO, BLACK.
TERMINALS - PHOSPHOR BRONZE.
METAL FORKLOCKS - PHOSPHOR BRONZE.
- FINISH:**
TERMINALS - .000030/0.00076 MINIMUM GOLD IN THE CONTACT AREA AND .000075/0.0019 MINIMUM TIN IN SOLDER TAIL AREA OVER .000050/0.0013 MINIMUM NICKEL OVERALL.
METAL FORKLOCKS - .00008/0.002 MINIMUM TIN OVERALL.
- PRODUCT SPECIFICATION PS-71109-9990 APPLIES.**
- CARD SLOT ACCEPTS .062 +.007/-.005 P.C. BOARD.**
- THE RECOMMENDED PLATING SPECIFICATION FOR THE MATING PC BOARD IS .000030/0.0076 MINIMUM GOLD OVER .000075/0.0019 MINIMUM NICKEL.**
- "SC330" AND MOLEX LOGO SHALL APPEAR ON BOTH SIDES OF HOUSING AND LOCATED APPROXIMATELY AS SHOWN.**
- FOUR DIGIT DATE CODE (YR/WK) SHALL BE LOCATED APPROXIMATELY AS SHOWN.**
- THE PRIMARY SHIPPING CARTON WILL BE LABELED "COMPLIANT TO ROHS DIRECTIVE 2002/95/EC AND ELV ANNEX II OF DIRECTIVE 2000/53/EC". CARTONS WITHOUT THIS LABEL MAY CONTAIN PRODUCT WITH LEAD.**

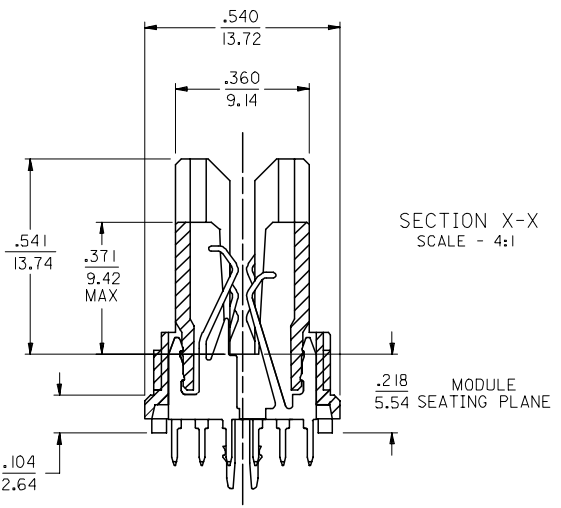
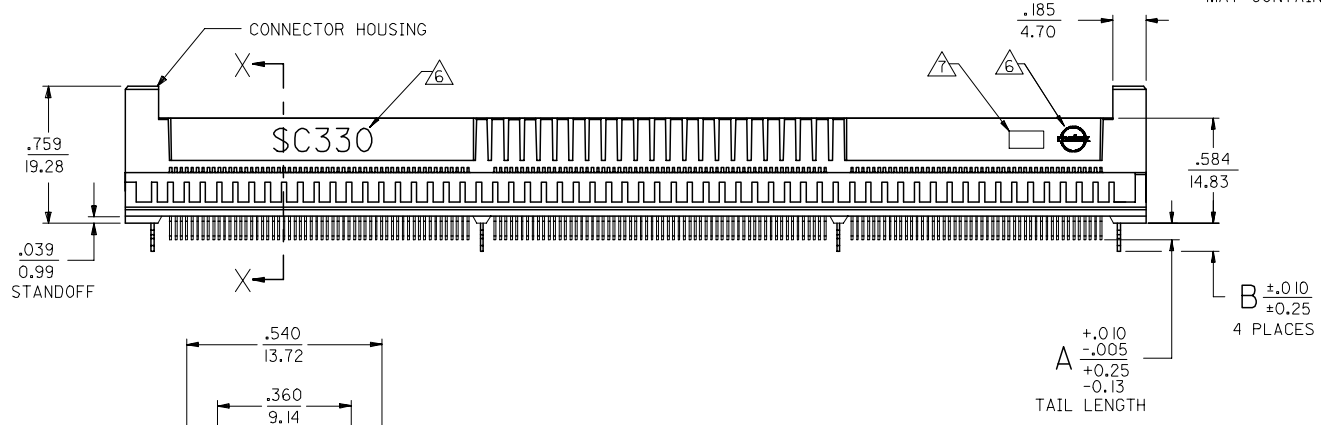
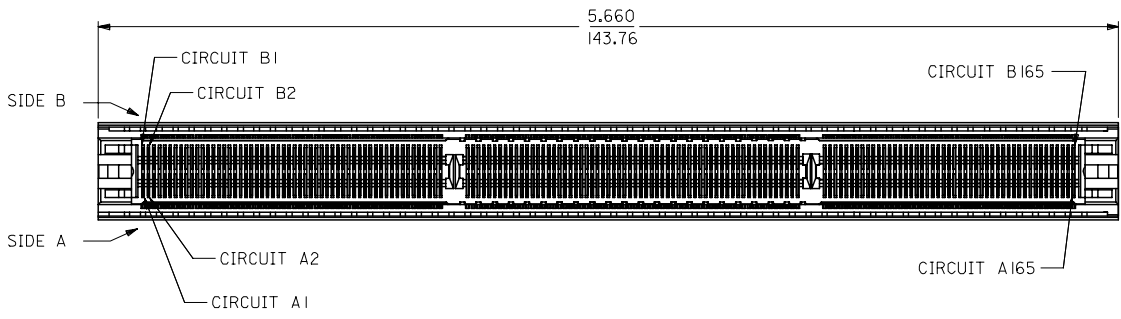

71109-5007	.140/3.56	.155/3.94
71109-5006	.115/2.92	.155/3.94
71109-5005	.090/2.29	.155/3.94

MAT'L NUMBER	A	B
--------------	---	---

MODIFY 71109-5007	DESCRIPTION
EC NO: UCP2006-1372	
DRWNS:BARRA 2005/12/19	
CHKD:DMORGAN 2006/01/05	
APPR:SMILLER 2006/01/06	

QUALITY SYMBOLS	GENERAL TOLERANCES (UNLESS SPECIFIED)	DIMENSION STYLE	SCALE	DESIGN UNITS	THIRD ANGLE PROJECTION
▽=0	mm INCH	IN/MM	2:1	INCH	
▽=0	4 PLACES ± --- ± ---	DRAWN BY DATE			
	3 PLACES ± --- ± .005	NELSON 1997/06/20			
	2 PLACES ± 0.13 ± ---	CHECKED BY DATE			
	1 PLACE ± --- ± ---	NELSON 1997/06/20			
	ANGULAR ±1/2°	APPROVED BY DATE			
		FUNCK 1997/06/20			
	DRAFT WHERE APPLICABLE MUST REMAIN WITHIN DIMENSIONS	MATERIAL NO.	SIZE	DOCUMENT NO.	SHEET NO.
		SEE TABLE	C	SD-71109-503	1 OF 2

TITLE	SALES ASSEMBLY SC330 HISPEC CONNECTOR W/METAL PEGS
MATERIAL NO.	SD-71109-503
DOCUMENT NO.	SD-71109-503
SHEET NO.	1 OF 2

2	F
1	J
SHT	REV

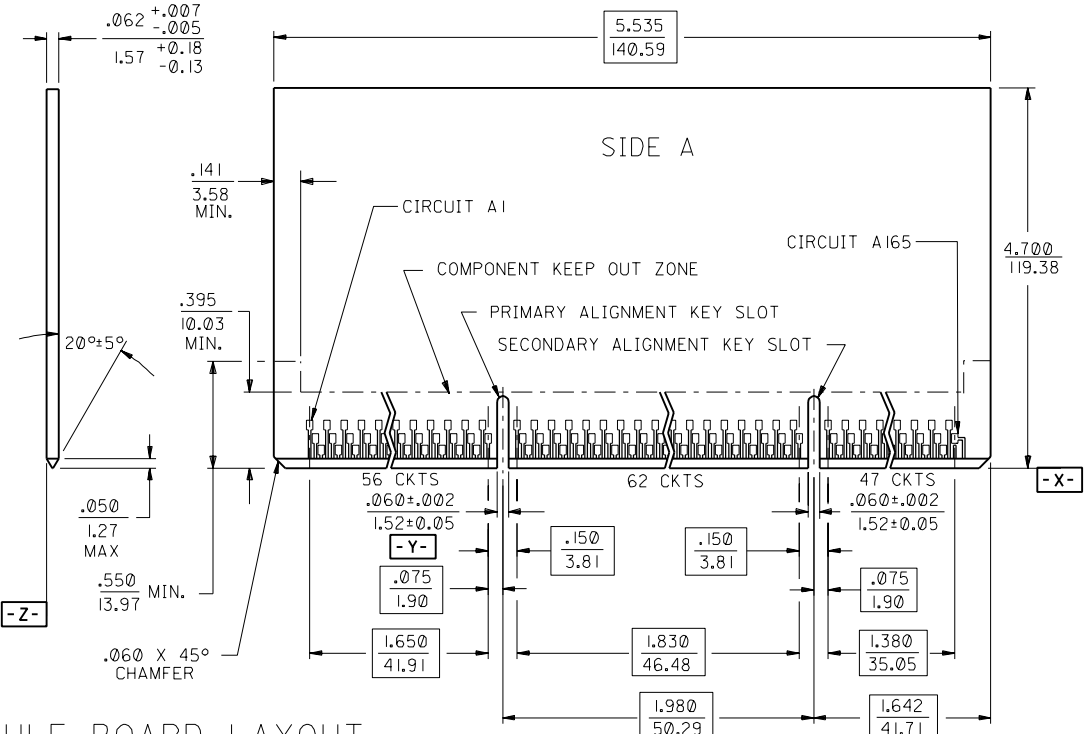
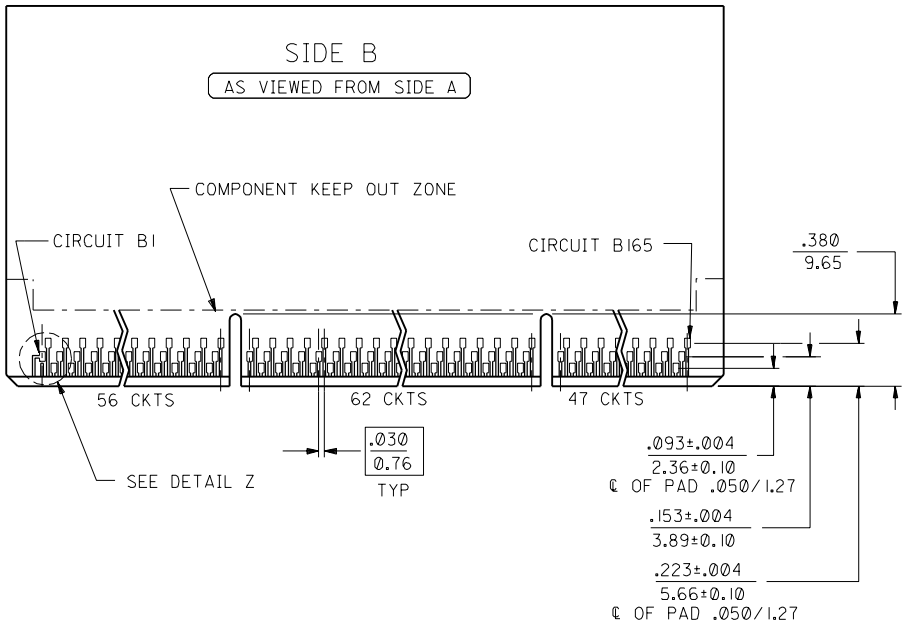

RECOMMENDED MODULE BOARD LAYOUT

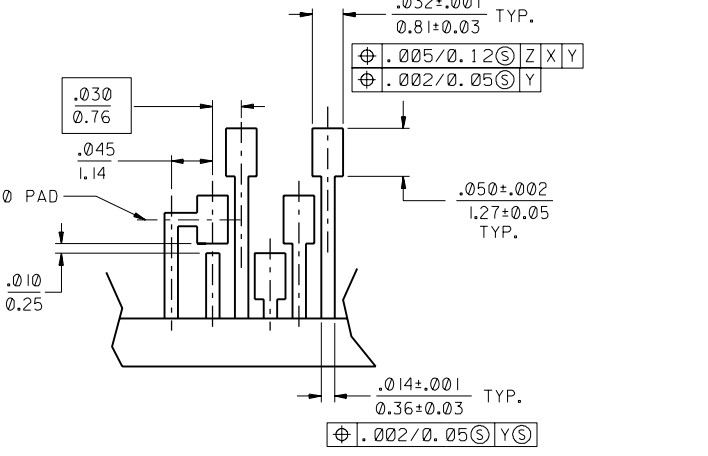
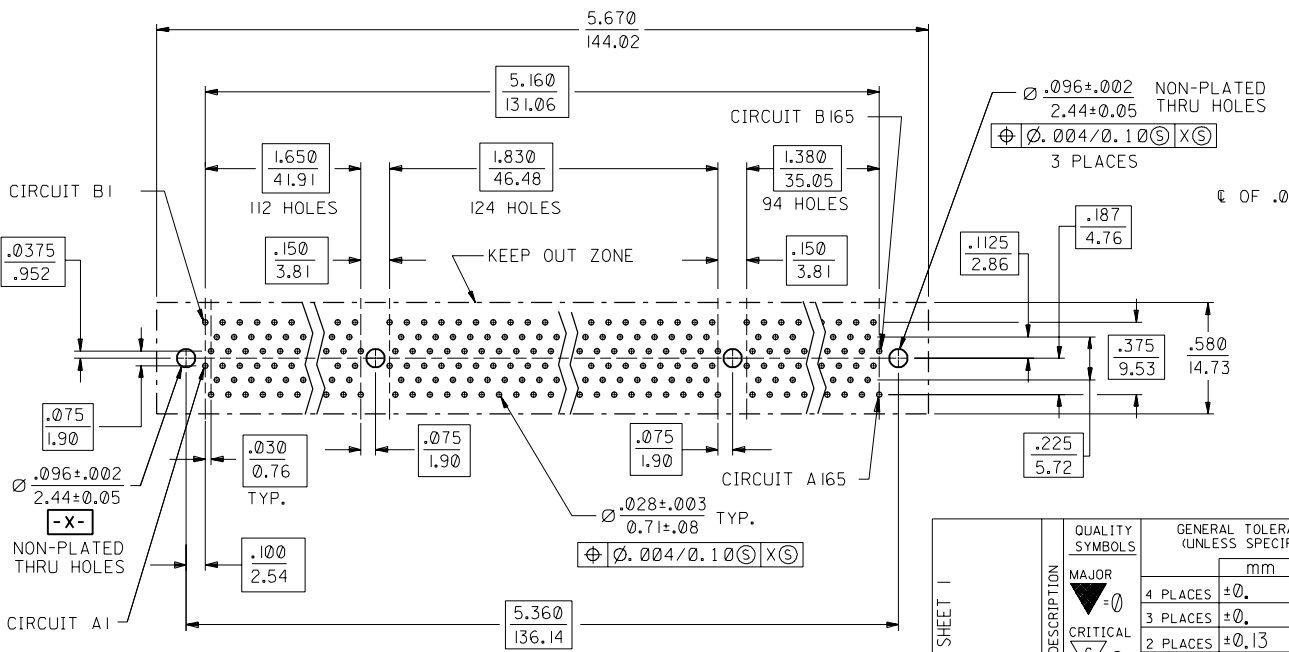

RECOMMENDED PCB HOLE LAYOUT

SEE SHEET 1	QUALITY SYMBOLS MAJOR CRITICAL	GENERAL TOLERANCES: (UNLESS SPECIFIED)		SCALE 2:1	DESIGN UNITS <input type="checkbox"/> mm <input checked="" type="checkbox"/> INCH	THIRD ANGLE PROJECTION	DIMENSIONS: <input type="checkbox"/> mm <input checked="" type="checkbox"/> INCH <input type="checkbox"/> mm ONLY	SHT	REV
		4 PLACES ±0.	±.	DRAWN BY & DATE NELSON 06/20/97	TITLE: SALES ASSEMBLY SC330 "HiSpec" CONNECTOR W/METAL FORKLLOCKS				
F	DESCRIPTION	3 PLACES ±0.	±.005	CHECKED BY & DATE NELSON 06/20/97	APPROVED BY & DATE FUNCK 06/20/97	MOLEX INCORPORATED			
		2 PLACES ±0.13	±.	CAD FILENAME S7110968.S02	MATERIAL NO. SEE TABLE	DRAWING NO. SD-71109-503	SHEET NO. 2	SIZE C	
		1 PLACE ±0.	±.	DRAFT WHERE APPLICABLE MUST REMAIN WITHIN DIMENSIONS		THIS DRAWING CONTAINS INFORMATION THAT IS PROPRIETARY TO MOLEX INCORPORATED AND SHOULD NOT BE USED WITHOUT WRITTEN PERMISSION.			