

Toggle Switches, AE Series, Process Sealed, Options

FUNCTIONS

The following functions available in SP or DP.

- 01** 2 Positions None indicates no mechanical position
 - 03** 3 Positions Off indicates a mechanical position with no electrical connection.
 - 05** 3 Positions (On) indicates momentary action.
 - 07** 3 Positions
 - 08** 2 Positions
- SPDT, connected terminals:
- DPDT, connected terminals:

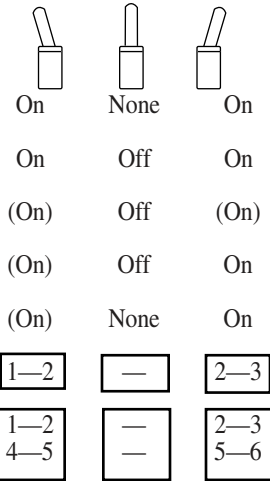

Functions available in DP case only:

- 11** 3 Positions
 - 13** 3 Positions
 - 15** 3 Positions
- DP3T Connect terminals:
- * SP3T Functions achieved with external jumper installed by customer

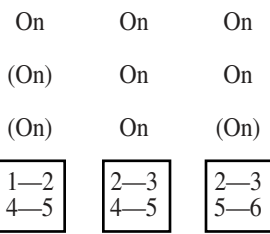

WIRING DIAGRAM FOR FUNCTIONS

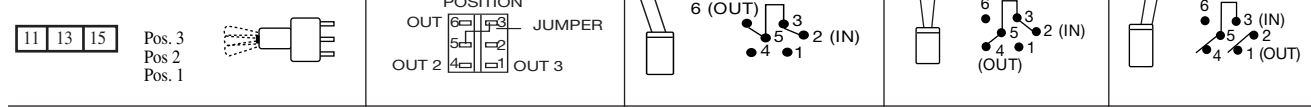

TOGGLES

S
Standard

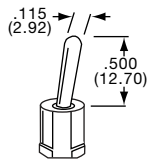

M
Short

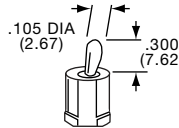

L
Lever

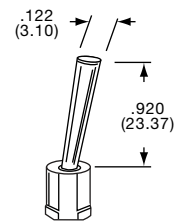

L1
Lever

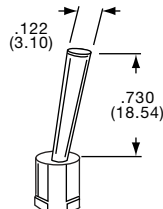

L2
Lever

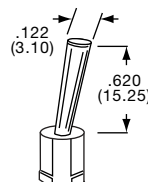

Bushing
D1

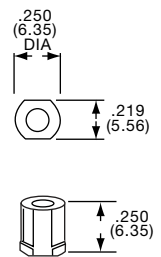

Toggle Switches, AE Series, Process Sealed, Options

TERMINALS

Z
Wire Lug

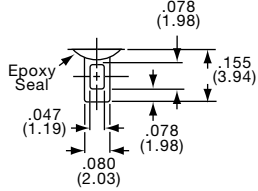

Z3
Quick Connect

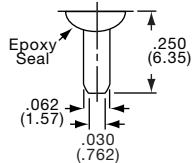

Mates with Tyco
61454 or 60900.

W
Wire Wrap

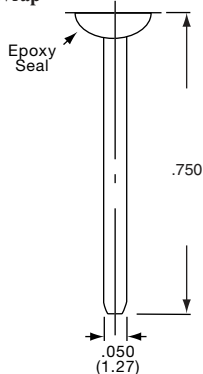

C
Printed Circuit
PC Hole Pattern

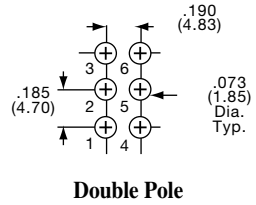
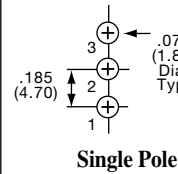
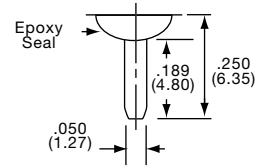

Single Pole

Double Pole

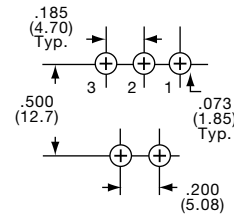
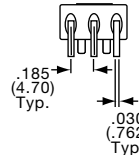
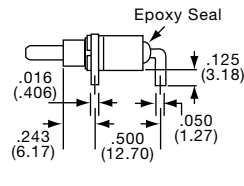
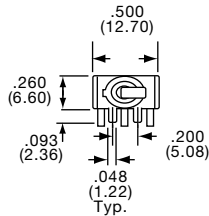

Right Angle
Single Pole

Note: Terminal numbers viewed from top of P.C. board

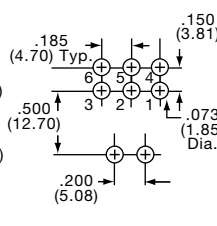
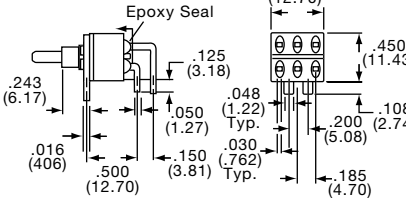
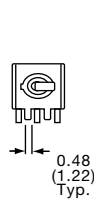

Right Angle
Double Pole

Note: Terminal numbers viewed from top of P.C. board

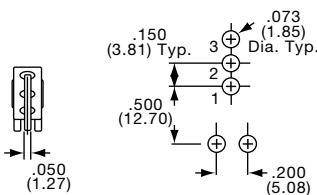
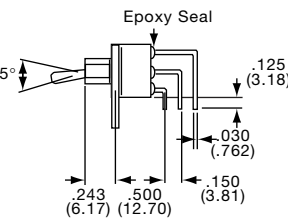
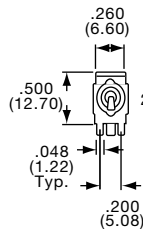

Vertical Right Angle
Single Pole

Note: Terminal numbers viewed from top of P.C. board

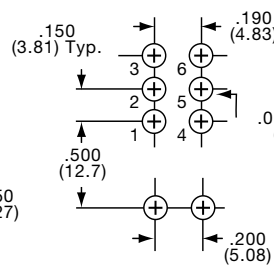
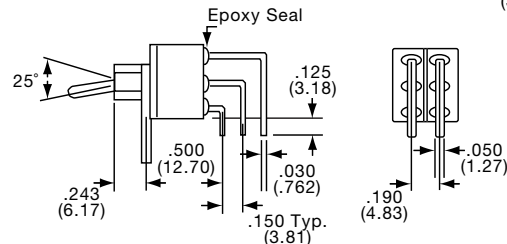
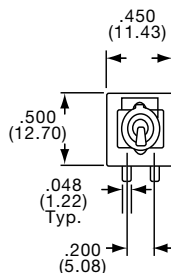

Vertical Right Angle
Double Pole

Note: Terminal numbers viewed from top of P.C. board

Toggle Switches, AE Series, Process Sealed, Options

V30

Vertical Support Bracket
Single Pole

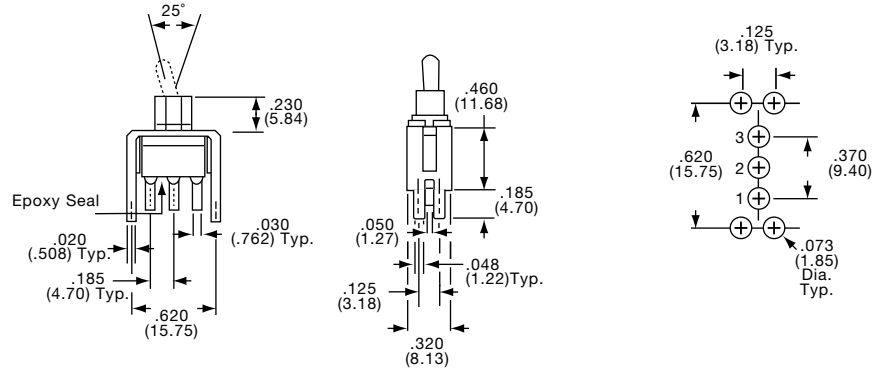

V30

Vertical Support Bracket
Double Pole

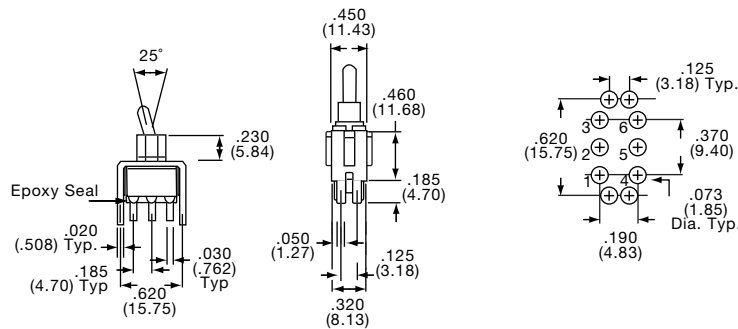

CONTACTS

B CONTACTS: Copper alloy with gold plate, welded button.

TERMINALS: Copper alloy with gold plate.

ELECTRICAL RATING: 0.4 VA @ 20 VAC/DC.

Q CONTACTS: Copper alloy with silver, welded button.

TERMINALS: Copper with silver/lead plate.

ELECTRICAL RATING: 5 A @ 125 VAC, 2 amps @ 250 VAC, 2 A @ 30 VDC.

UL/CSA RATING: 5A @ 125 VAC, 3 @ 250 VAC.
(Specify "UL" option code)

G CONTACTS: Copper alloy with gold plate over silver, welded button.

TERMINALS: Copper alloy, with gold plate.

ELECTRICAL RATING: 0.4 VA @ 20 VAC/DC or 5 A @ 125 VAC, 2 A @ 250 VAC, 2 A @ 30 VDC.

Note: This contact option can be used for low-level or power switching. If level is above 0.4 VA @ 20 VAC/DC, the switch is rendered usable only for power switching due to arc-removal of gold plate.

UL/CSA RATING: 5A @ 125 VAC, 3A @ 250 VAC
(Specify "UL" option code)

Toggle Switches, AE Series, Process Sealed, Vertical, Long Bat Actuator

* Refer to Pages C35-C38 for Additional Options *

SEE PAGE C35 FOR PRODUCT SPECIFICATIONS

SPDT



AE101SD1CQ

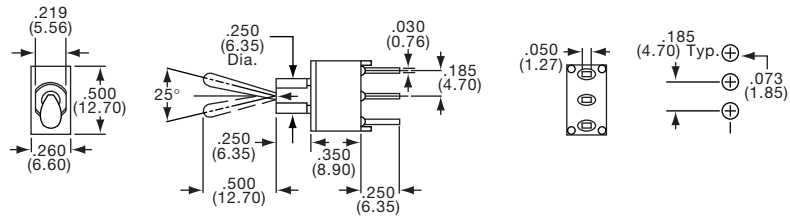

Tyco Electronics	Alcoswitch	Tyco Electronics	Alcoswitch	Type	Act. Code	P. M5			
Silver Contacts		Gold Contacts							
2-1437556-8	AE101SD1CQ	2-1437556-7	AE101SD1CB	SPDT	1		On	None	On
3-1437556-8	AE103SD1CQ	3-1437556-7	AE103SD1CB	SPDT	5		On	Off	On
	AE105SD1CQ	4-1437556-6	AE105SD1CB	SPDT	5		(On)	Off	(On)
	AE107SD1CQ	5-1437556-3	AE107SD1CB	SPDT	5		On	Off	(On)
6-1437556-1	AE108SD1CQ	AE108SD1CB	SPDT	1			On	None	(On)

DPDT



AE201SD1CQ

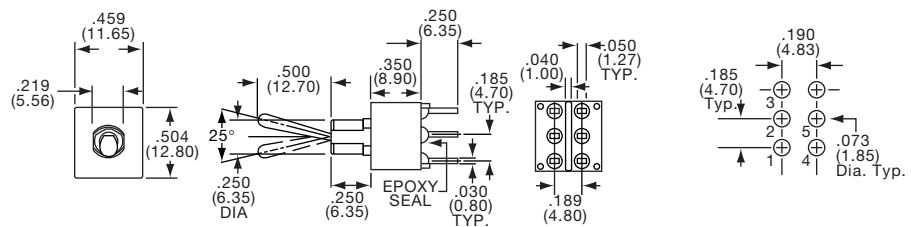

Tyco Electronics	Alcoswitch	Tyco Electronics	Alcoswitch	Type	Act. Code	P. M5			
Silver Contacts		Gold Contacts							
7-1437556-5	AE201SD1CQ	7-1437556-4	AE201SD1CB	DPDT	2		On	None	On
	AE203SD1CQ	8-1437556-2	AE203SD1CB	DPDT	6		On	Off	On
8-1437556-5	AE205SD1CQ	AE205SD1CB	DPDT	6			(On)	Off	(On)
	AE207SD1CQ	AE207SD1CB	DPDT	6			On	Off	(On)
	AE208SD1CQ	AE208SD1CB	DPDT	2			On	None	(On)
	AE211SD1CQ	AE211SD1CB	DPDT	11			On	On	On
	AE215SD1CQ	AE215SD1CB	DPDT	11			(On)	On	(On)

Toggle Switches, AE Series, Process Sealed, Right Angle, Short Bat Actuator

* Refer to Pages C35-C38 for Additional Options *

SEE PAGE C35 FOR PRODUCT SPECIFICATIONS

SPDT

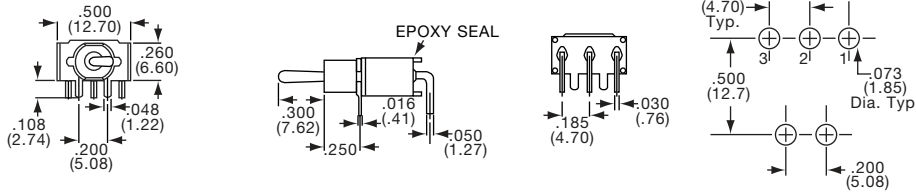

AE101MD1AQ
Horizontal Actuation

Tyco Electronics	Alcoswitch	Tyco Electronics	Alcoswitch	Type	Act. Code	P. M5			
Silver Contacts		Gold Contacts							
1-1437556-1	AE101MD1AQ	1437556-8	AE101MD1AB	SPDT	1	On	None	On	
	AE103MD1AQ	3-1437556-1	AE103MD1AB	SPDT	5	On	Off	On	
5-1437556-7	AE108MD1AQ		AE108MD1AB	SPDT	1	On	None	(On)	

DPDT

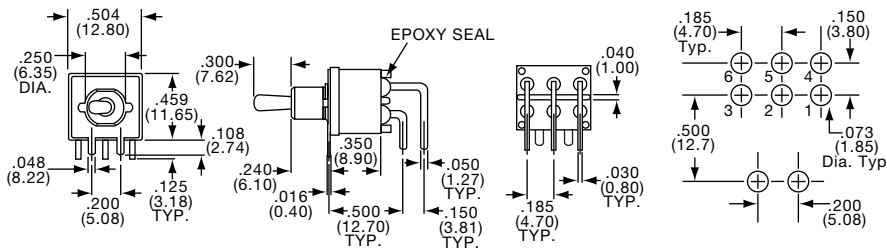

AE201MD1AQ
Horizontal Actuation

Tyco Electronics	Alcoswitch	Tyco Electronics	Alcoswitch	Type	Act. Code	P. M5			
Silver Contacts		Gold Contacts							
6-1437556-6	AE201MD1AQ	6-1437556-5	AE201MD1AB	DPDT	2	On	None	On	
3-1437592-1	AE203MD1AQ	7-1437556-7	AE203MD1AB	DPDT	6	On	Off	On	
	AE208MD1AQ		AE208MD1AB	DPDT	2	On	None	(On)	

SPDT

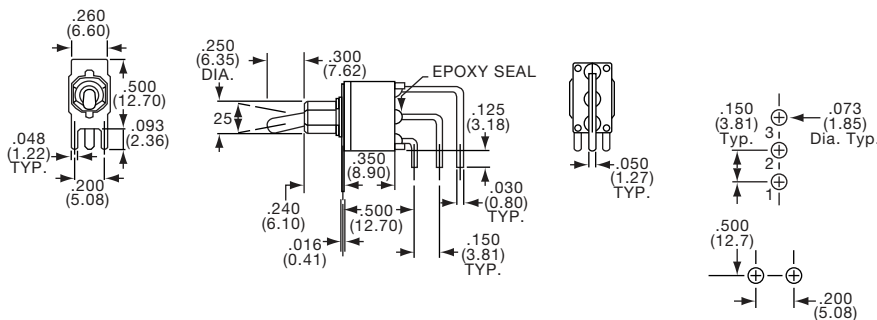

AE101MD1AV2Q
Vertical Actuation

Tyco Electronics	Alcoswitch	Tyco Electronics	Alcoswitch	Type	Act. Code	P. M5			
Silver Contacts		Gold Contacts							
1-1437556-3	AE101MD1AV2Q	1-1437556-2	AE101MD1AV2B	SPDT	1	On	None	On	
	AE103MD1AV2Q	3-1437556-2	AE103MD1AV2B	SPDT	5	On	Off	On	
1447331-4	AE108MD1AV2Q	5-1437556-8	AE108MD1AV2B	SPDT	1	On	None	(On)	

Toggle Switches, AE Series, Process Sealed, Short Bat Actuator

* Refer to Pages C35-C38 for Additional Options *

SEE PAGE C35 FOR PRODUCT SPECIFICATIONS

DPDT



AE201MD1AV2Q

Vertical Actuation

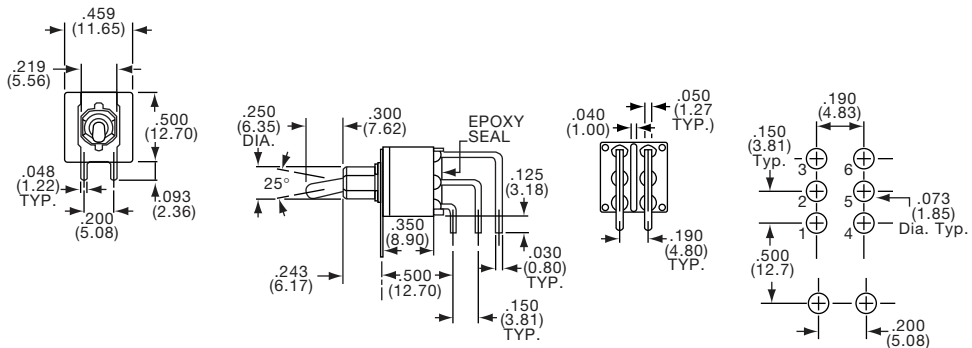

Tyco Electronics	Alcoswitch	Tyco Electronics	Alcoswitch	Type	Act. Code	P. M5			
Silver Contacts 1571537-1	AE201MD1AV2Q	Gold Contacts 6-1437556-7	AE201MD1AV2B	DPDT	2		On	None	On
	AE203MD1AV2Q	7-1437556-8	AE203MD1AV2B	DPDT	6		On	Off	On
	AE208MD1AV2Q		AE208MD1AV2B	DPDT	2		On	None	(On)

SPDT



AE101MD1CQ

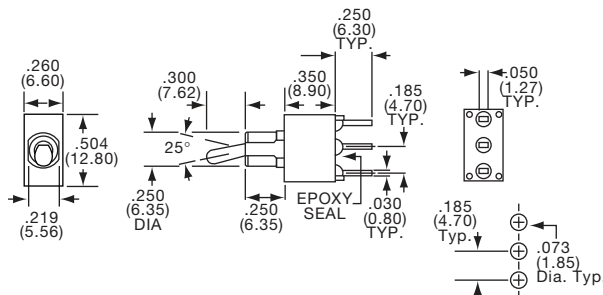

Tyco Electronics	Alcoswitch	Type	Act. Code	P.M5			
Silver Contacts 1-1437556-7	AE101MD1CQ	SPDT	1		On	None	On
	AE103MD1CQ	SPDT	5		On	Off	On
	AE105MD1CQ	SPDT	5		(On)	Off	(On)
	AE107MD1CQ	SPDT	5		On	Off	(On)
	AE108MD1CQ	SPDT	1		On	None	(On)
Gold Contacts 1-1437556-5	AE101MD1CB	SPDT	1		On	None	On
3-1437556-3	AE103MD1CB	SPDT	5		On	Off	On
	AE105MD1CB	SPDT	5		(On)	Off	(On)
	AE107MD1CB	SPDT	5		On	Off	(On)
	AE108MD1CB	SPDT	1		On	None	(On)

DPDT



AE201MD1CQ

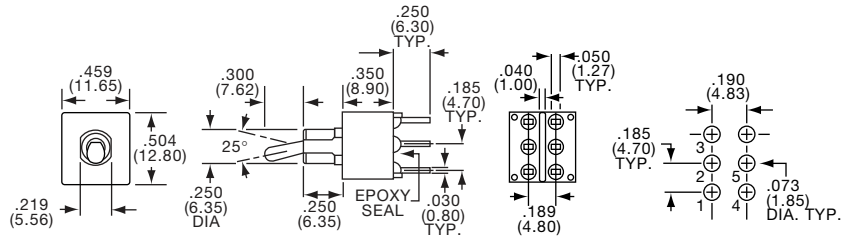

Tyco Electronics	Alcoswitch	Type	Act. Code	P.M5				Tyco Electronics	Alcoswitch	Type	Act. Code	P.M5			
Silver Contacts 6-1437556-9	AE201MD1CQ	DPDT	2		On	None	On	Gold Contacts 6-1437556-8	AE201MD1CB	DPDT	2		On	None	On
	AE203MD1CQ	DPDT	6		On	Off	On		AE203MD1CB	DPDT	6		On	Off	On
	AE205MD1CQ	DPDT	6		(On)	Off	(On)		AE205MD1CB	DPDT	6		(On)	Off	(On)
	AE207MD1CQ	DPDT	6		On	Off	(On)		AE207MD1CB	DPDT	6		On	Off	(On)
	AE208MD1CQ	DPDT	2		On	None	(On)		AE208MD1CB	DPDT	2		On	None	(On)
	AE211MD1CQ	SP3T	11		On	On	On	8-1437556-9	AE211MD1CB	SP3T	11		On	On	On
	AE215MD1CQ	SP3T	11		(On)	On	(On)		AE215MD1CB	SP3T	11		(On)	On	(On)

Toggle Switches, AE Series, Process Sealed, Right Angle, Long Bat Actuator

* Refer to Pages C35-C38 for Additional Options *

SEE PAGE C35 FOR PRODUCT SPECIFICATIONS

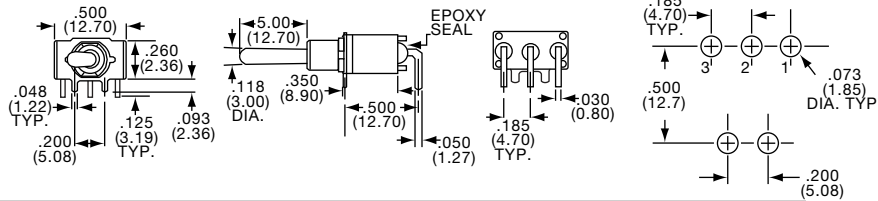

SPDT



AE101SD1AQ
Horizontal Actuation

Tyco Electronics	Alcoswitch	Tyco Electronics	Alcoswitch	Type	Act. Code	P. M5			
Silver Contacts		Gold Contacts							
6-1437556-0	AE101SD1AQ	2-1437556-2	AE101SD1AB	SPDT	1		On	None	On
	AE103SD1AQ		AE103SD1AB	SPDT	5		On	Off	On
2-1437556-3	AE108SD1AQ	5-1437556-9	AE108SD1AB	SPDT	5		(On)	Off	(On)

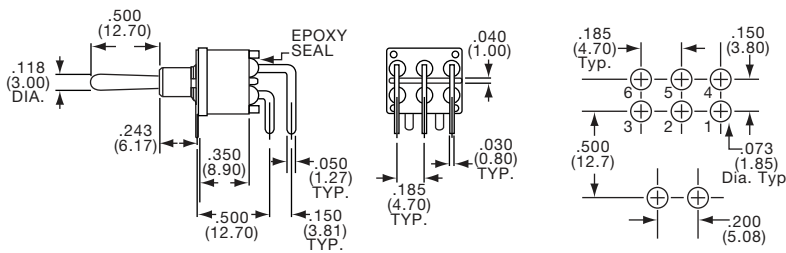

DPDT



AE201SD1AB
Horizontal Actuation

Tyco Electronics	Alcoswitch	Tyco Electronics	Alcoswitch	Type	Act. Code	P. M5			
Silver Contacts		Gold Contacts							
	AE201SD1AQ	7-1437556-1	AE201SD1AB	DPDT	2		On	None	On
	AE203SD1AQ		AE203SD1AB	DPDT	6		On	Off	On
	AE208SD1AQ	7-1437556-9	AE208SD1AB	DPDT	6		(On)	Off	(On)

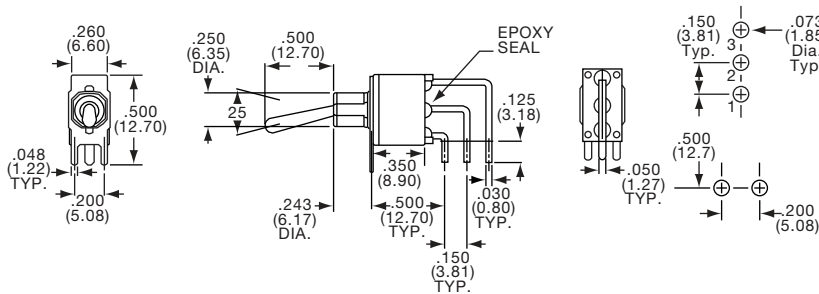

SPDT



AE101SD1AV2B
Vertical Actuation

Tyco Electronics	Alcoswitch	Tyco Electronics	Alcoswitch	Type	Act. Code	P. M5			
Silver Contacts		Gold Contacts							
2-1437556-6	AE101SD1AV2Q	2-1437556-5	AE101SD1AV2B	SPDT	1		On	None	On
	AE103SD1AV2Q	3-1437556-6	AE103SD1AV2B	SPDT	5		On	Off	On
	AE108SD1AV2Q		AE108SD1AV2B	SPDT	5		(On)	Off	(On)

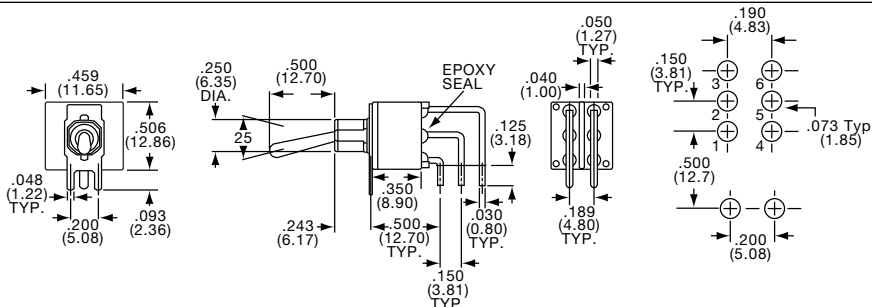

DPDT



AE201SD1AV2Q
Vertical Actuation

Tyco Electronics	Alcoswitch	Tyco Electronics	Alcoswitch	Type	Act. Code	P. M5			
Silver Contacts		Gold Contacts							
8-1437556-1	AE201SD1AV2Q	7-1437556-3	AE201SD1AV2B	DPDT	2		On	None	On
	AE203SD1AV2Q	8-1437556-0	AE203SD1AV2B	DPDT	6		On	Off	On
	AE208SD1AV2Q		AE208SD1AV2B	DPDT	6		(On)	Off	(On)