

Power Management IC For Automotive R-Car Series

BD9576MUF-C

General Description

BD9576MUF-C is a Power Management Integrated Circuit (PMIC) designed specifically for use on R-Car series processor for In-Vehicle Infotainment (IVI) Systems, Instrument Cluster Panel and Advanced Driver Assistance Systems (ADAS).

Features

- AEC-Q100 Qualified^(Note 1)
 - Safety mechanism is implemented to support functional safety (ASIL-B)
 - Customizable Power Up / Down Sequence and State Control
 - Fewer External Components Count / Compact Size Power Control Logic with Processor Interface and Event Detection
 - Built-in UVLO, SCP, OVP, UVP, OCP and TSD Protection
 - Built-in OVD,UVD,TW
 - Built-in Self Diagnosis
 - Built-in Mutual Monitoring Functions of VREF
 - Built-in Mutual Monitoring Functions of OSC
- ^(Note 1) Grade1

Applications

- In-Vehicle Infotainment (IVI) Systems
- Instrument Cluster Panel
- Advanced Driver Assistance Systems (ADAS)

Key Specifications

- Input Voltage Range: 3.0 V to 3.6 V
- VOUT1 (VD50) Output Voltage: 5 V (Typ)
- VOUT1 (VD50) Output Current: 0.2 A (Max)
- VOUT2 (VD18) Output Voltage: 1.8 V (Typ)
- VOUT2 (VD18) Output Current: 1.0 A (Max)
- VOUT3 (DDR) Output Voltage: 1.35 V (Typ, DDR3L)^(Note 2)
1.50 V (Typ, DDR3)^(Note 2)
- VOUT3 (DDR) Output Current: 2.0 A (Max)
- VOUT4 (VD10A, VD10B) Output Voltage: 1.03 V (Typ)
- VOUT4 (VD10A, VD10B) Output Current: 5.2 A (Max)
- VOUTL1 (VL25) Output Voltage: 2.5 V (Typ)
- VOUTL1 (VL25) Output Current: 0.15 A (Max)
- VOUTS1 (VS33) Output Voltage: VIN7 = 3.3 V (Typ)
- VOUTS1 (VS33) Output Current: 0.3 A (Max)
- Operating Ambient Temperature Range: -40 °C to +125 °C

^(Note 2) Select Voltage by the DDR_SEL pin.

Special Characteristics

- Output Voltage:
(VOUT1 (VD50), VOUT2 (VD18), VOUT3 (DDR),
VOUT4 (VD10A, VD10B), VOUTL1 (VL25),
VOUTS1 (VS33))

Package

VQFN56FV8080
(Wettable Flank)

W (Typ) x D (Typ) x H (Max)

8.0 mm x 8.0 mm x 1.0 mm

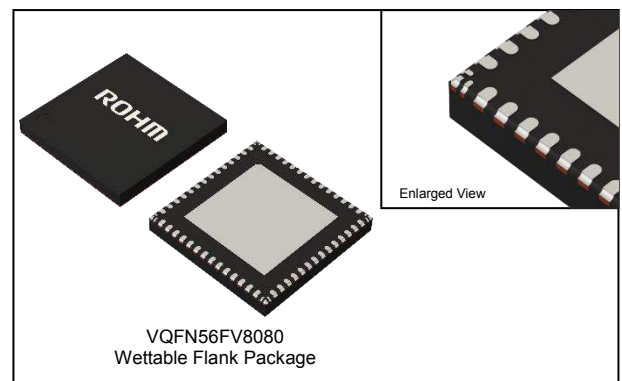

Block Diagram

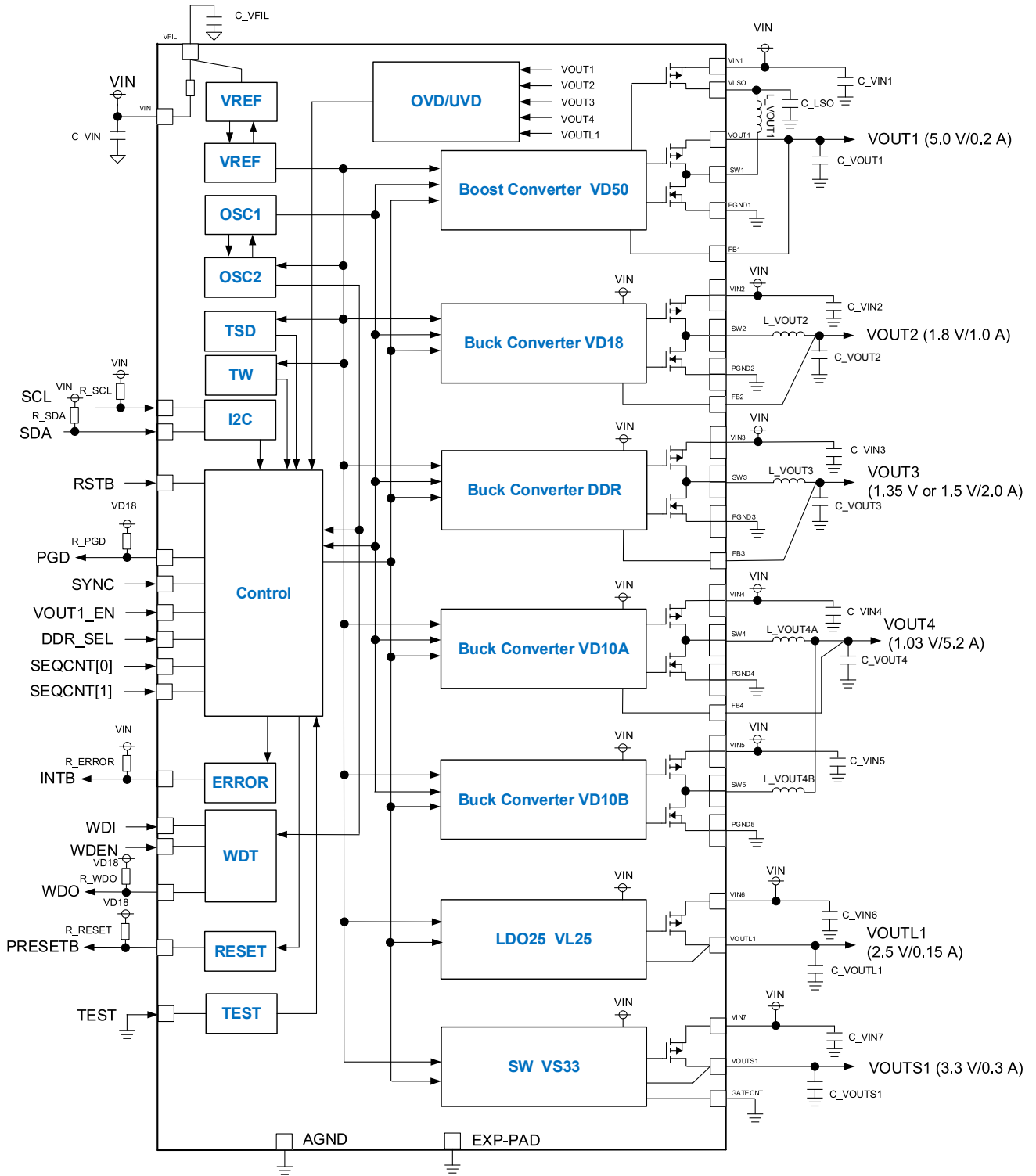

Pin Configuration

(TOP VIEW)

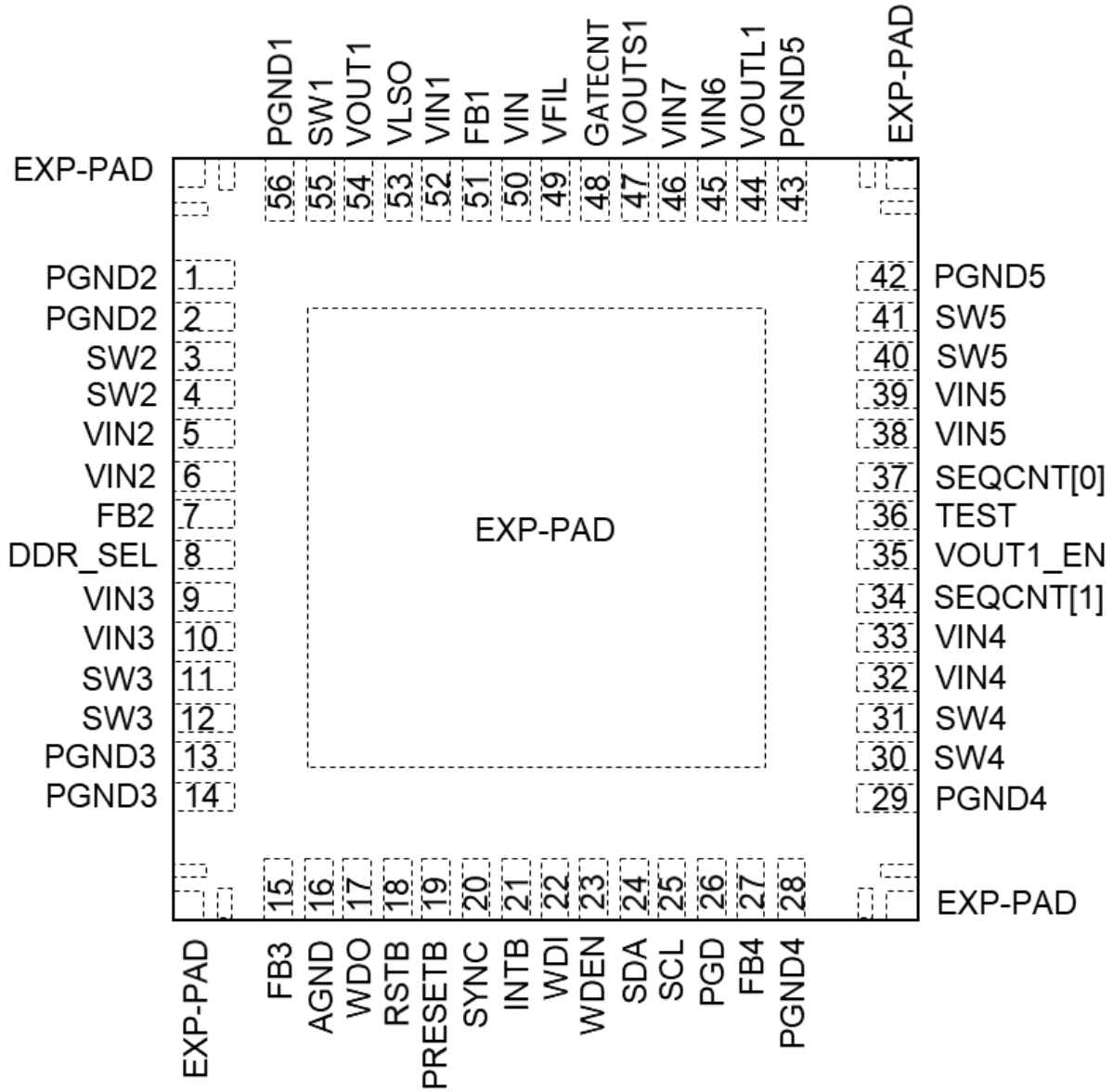

Pin Description

Pin No.	Pin Name	I/O	Function
1	PGND2	-	Power GND for VOUT2
2	PGND2	-	Power GND for VOUT2
3	SW2	O	High side MOSFET source / Low side MOSFET sink pin for VOUT2
4	SW2	O	High side MOSFET source / Low side MOSFET sink pin for VOUT2
5	VIN2	I (POWER)	Power supply for VOUT2
6	VIN2	I (POWER)	Power supply for VOUT2
7	FB2	I	Feedback pin for VOUT2
8	DDR_SEL	I	VOUT3 Voltage is changed by DDR_SEL. DDR_SEL = H: 1.5 V, DDR_SEL = L: 1.35 V (internal 100 kΩ pull down)
9	VIN3	I (POWER)	Power supply for VOUT3
10	VIN3	I (POWER)	Power supply for VOUT3
11	SW3	O	High side MOSFET source / Low side MOSFET sink pin for VOUT3
12	SW3	O	High side MOSFET source / Low side MOSFET sink pin for VOUT3
13	PGND3	-	Power GND for VOUT3
14	PGND3	-	Power GND for VOUT3
15	FB3	I	Feedback pin for VOUT3
16	AGND	-	GND
17	WDO	O (O.D.) ^(Note 1)	Watchdog Timer error signal.
18	RSTB	I	Power On (internal 100 kΩ pull down)
19	PRESETB	O (O.D.) ^(Note 1)	Reset signal for SoC
20	SYNC	I	External sync for DCDC (internal 100 kΩ pull down)
21	INTB	O (O.D.) ^(Note 1)	Interrupt signal
22	WDI	I	Clock signal input as Watch Dog Timer function. (internal 100 kΩ pull down)
23	WDEN	I	Watch Dog Timer function setting ON/OFF. (internal 100 kΩ pull down)
24	SDA	I/O (O.D.) ^(Note 1)	I2C Data
25	SCL	I/O (O.D.) ^(Note 1)	I2C CLK
26	PGD	O (O.D.) ^(Note 1)	POWER Good Function
27	FB4	I	Feedback pin for VOUT4
28	PGND4	-	Power GND for VOUT4
29	PGND4	-	Power GND for VOUT4
30	SW4	O	High side MOSFET source / Low side MOSFET sink pin for VOUT4
31	SW4	O	High side MOSFET source / Low side MOSFET sink pin for VOUT4
32	VIN4	I (POWER)	Power supply for VOUT4
33	VIN4	I (POWER)	Power supply for VOUT4
34	SEQCNT[1]	I	Adjust shutdown timing of VD18. Multi-threshold PIN. (internal 2 MΩ pull down)
35	VOUT1_EN	I	Enable control pin for VOUT1 (internal 100 kΩ pull down)
36	TEST	I	Connected to AGND. TEST MODE PIN
37	SEQCNT[0]	I	Adjust start and OFF timing. Multi-threshold PIN. (internal 2 MΩ pull down)
38	VIN5	I (POWER)	Power supply for VOUT4
39	VIN5	I (POWER)	Power supply for VOUT4

(Note 1) O.D. = Open Drain

Pin Description – continued

Pin No.	Pin Name	I/O	Function
40	SW5	O	High side MOSFET source / Low side MOSFET sink pin for VOUT4
41	SW5	O	High side MOSFET source / Low side MOSFET sink pin for VOUT4
42	PGND5	-	Power GND for VOUT4
43	PGND5	-	Power GND for VOUT4
44	VOU1L1	O	Output of VOU1L1
45	VIN6	I (POWER)	Power supply for VOU1L1
46	VIN7	I (POWER)	Power supply for VOUTS1
47	VOUTS1	O	SW Output
48	GATECNT	O	Control Gate of External PMOS SW. When use External PMOS. If External PMOS SW is not used, please connect to GND.
49	VFIL	O	Output of filtering VIN.
50	VIN	I (POWER)	Power supply for PMIC
51	FB1	I	Feedback pin for VOUT1
52	VIN1	I (POWER)	Power supply for VOUT1
53	VLSO	O	Output of LDSW
54	VOUT1	O	Output of VOUT1
55	SW1	O	High side MOSFET source / Low side MOSFET sink pin for VOUT1
56	PGND1	-	Power GND for VOUT1
-	EXP-PAD (CORNER)	-	GND (EXP-PAD (CORNER) short-circuit with EXP-PAD (CENTER) into the Package)
-	EXP-PAD (CENTER)	-	GND (Connect to common GND of PCB)

Physical Dimension and Packaging Information

Package Name	VQFN56FV8080
--------------	--------------

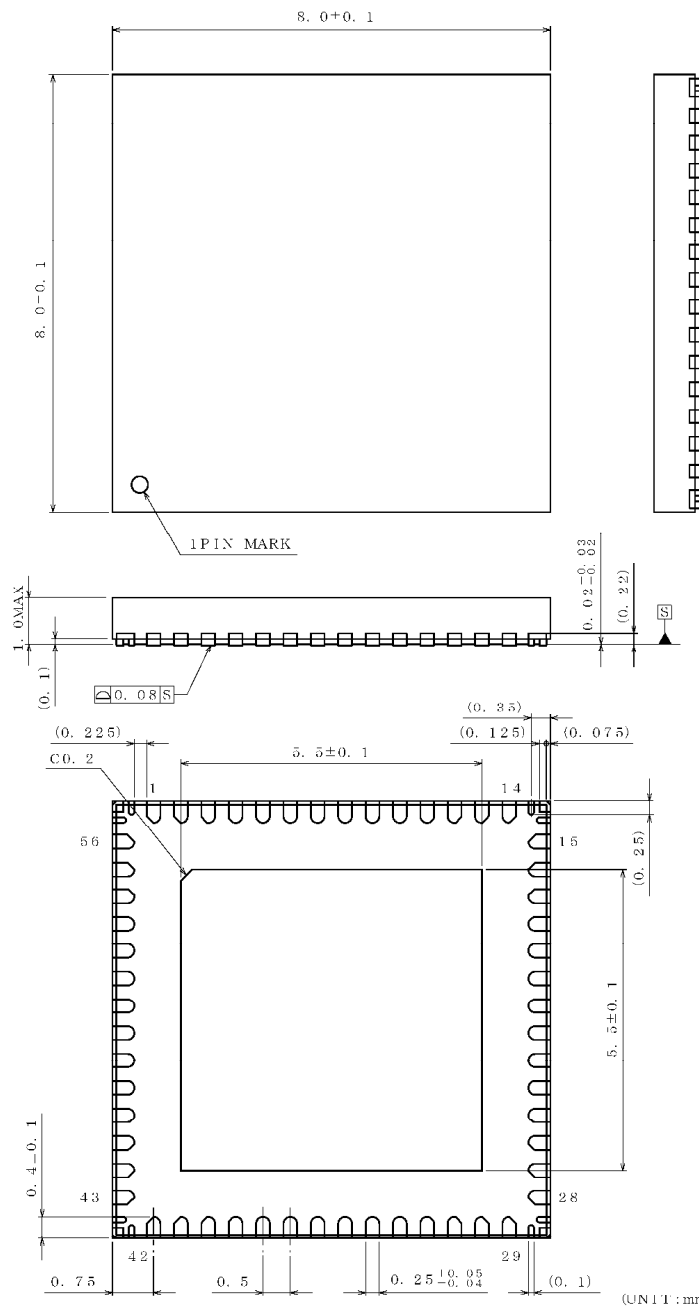

NOTE: Dimensions in () for reference only.

PKG: VQFN56FV8080
Drawing No. EX409-5001-1

< Tape and Reel Information >

Tape	Embossed carrier tape
Quantity	1000pcs
Direction of feed	E2 The direction is the pin 1 of product is at the upper left when you hold reel on the left hand and you pull out the tape on the right hand

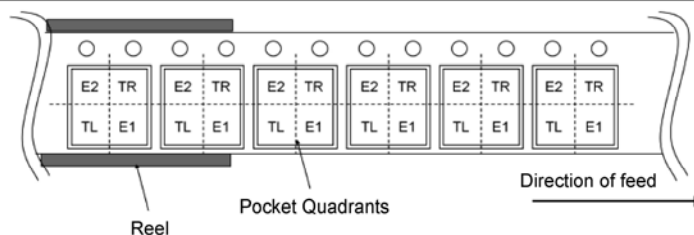

Footprint Dimension

Package Name

VQFN56FV8080

Footprint dimensions

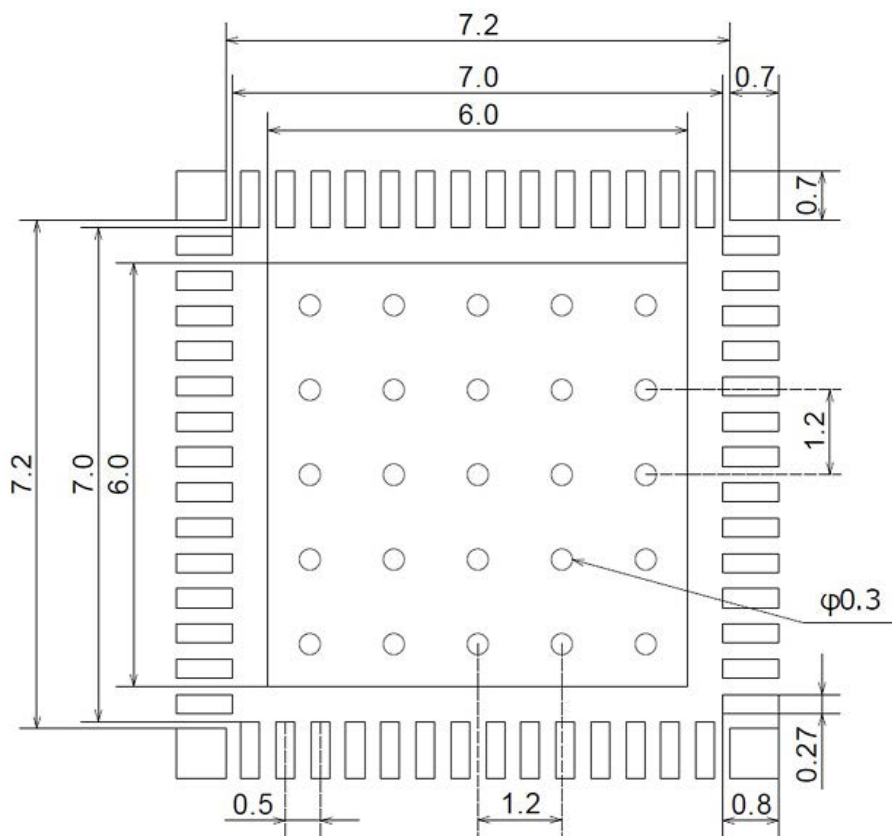

(unit:mm)

In actual design, please optimize in accordance with the situation of your board design and soldering condition.

Ordering Information

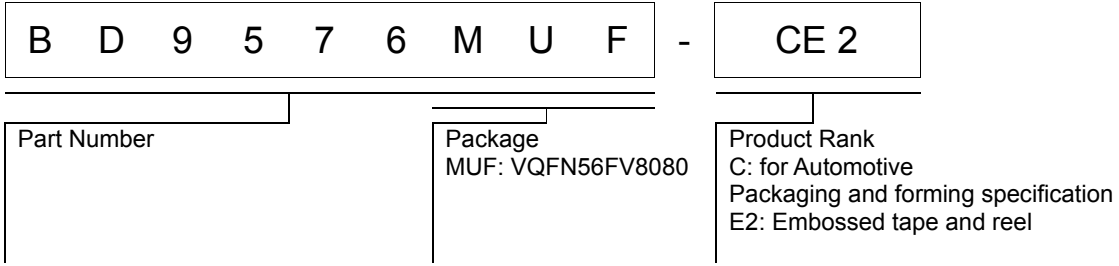

Marking Diagram

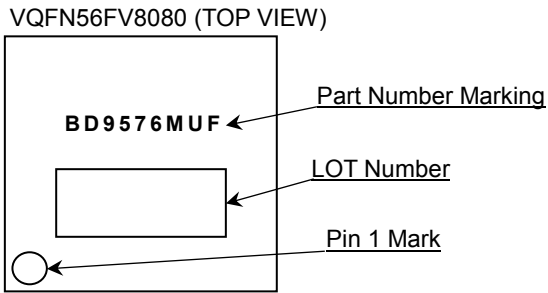

Contents

General Description	1
Features.....	1
Applications	1
Key Specifications	1
Special Characteristics	1
Package.....	1
Block Diagram	2
Pin Configuration.....	3
Pin Description.....	4
Physical Dimension and Packaging Information	6
Footprint Dimension.....	7
Ordering Information.....	8
Marking Diagram	8
Contents	9
1. Device Feature.....	13
1.1 Output Voltage Table	13
1.2 Signal Line Diagram for PMIC	14
2. Application	15
3. Electrical Characteristics.....	17
3.1 Absolute Maximum Ratings.....	17
3.2 Thermal Resistance.....	18
3.3 Recommended Operating Conditions.....	19
3.4 DC Characteristics.....	20
3.5 Protection Mode (Under Voltage Lock Out).....	25
3.6 Protection Mode (Thermal Shutdown).....	25
3.7 Protection Mode (Thermal Warning).....	25
3.8 Protection Mode	25
3.9 Mutual Monitor Function (VREF, OSC).....	26
4. Function Description	27
4.1 Pin Control Function.....	27
4.1.1 VOUT1_EN Input	27
4.1.2 RSTB Input.....	27
4.1.3 PIN Setting Judge Timing.....	27
4.1.4 Output Power-ON/Power-OFF Sequence	28
4.1.5 VOUT2 (VD18) Discharge Start Timing.....	29
4.1.6 Countermeasures for Hang-Up	29
4.1.7 Interval Setting	30
4.1.8 Initializing Control Circuit.....	30
4.1.9 VOUT1 Mode Setting	31
4.1.10 State Machine.....	33
4.2 Whole Sequence Control.....	35
4.2.1 Whole Sequence (State Chart).....	35
4.2.2 General Sequence Description.....	35
4.2.3 I2C Accessible State Condition	35
4.2.4 EEPROM Load Function and Internal OSC Stable Time.....	36
4.2.5 Self Diagnosis	36
4.2.6 Prevention of Repetition for Protection Error, EEPROM CRC Error, Self Diagnosis Error	36
4.3 VOUT1/VOUTL1 Disable Setting without EEPROM.....	37
4.4 VOUTS1 Disable Setting without EEPROM, Internal/External SW Mode Setting	38
4.5 I2C I/F.....	39
4.6 Interrupt Function	43
4.6.1 Interrupt Function Description	43
4.6.2 Interruption Factor.....	44
4.7 Power Abnormality Monitoring Function (Protection Error Detection).....	47
4.8 SYNC Function.....	49
4.9 WDT Function.....	50
5. Register Specification	53
5.1 Register Map	53
5.2 Register Description.....	54
5.2.1 Recognition Code Indicator	54
5.2.2 FuSa Mode (Error Detection/Rectification Mode).....	54
5.2.3 Shutdown Control.....	55
5.2.4 Spread Spectrum Clock Generation Control for Internal OSC.....	55
5.2.5 SMRB Control using I2C Control (Software Manual Reset for PRESETB)	56
5.2.6 Watch Dog Timer setting	56
5.2.7 Oscillator Enable in STANDBY State.....	56
5.2.8 The PGD Pin Output Assert Condition Setting	57
5.2.9 PMIC Internal Status	57

5.2.10	I2C FuSa Mode Error Bit Location	58
5.2.11	INTB Interruption Factor and Mask Condition	59
5.2.12	POW Setting	64
5.2.13	VOUT Voltage Tune / OVD SET / UVD SET	67
5.2.14	VOOTS1 OCW SET	73
5.2.15	VOOTS1 OCP SET	73
5.2.16	Diglitch time	74
6.	Typical Performance Curves	75
6.1	Line Regulation	75
6.2	Load Regulation	77
6.3	Power Efficiency	79
6.4	Power ON Waveform	81
6.5	Power OFF Waveform	83
6.6	Load Transient	85
7.	Operational Notes	87
8.	Revision History	90

Table 1: Output Voltage Table of Each State	13
Table 2: Application circuit components list.....	16
Table 3: Absolute Maximum Rating	17
Table 4: Recommended Operating Conditions	19
Table 5: DC Characteristics (Unless otherwise specified, T _j = -40 °C to +150 °C, V _{IN} = 3.3 V)	20
Table 6: Logic Characteristics (Unless otherwise specified, T _j = -40 °C to +150 °C, V _{IN} = 3.3 V).....	24
Table 7: Protection Mode (General).....	25
Table 8: Protection Mode (VD50, DDR, VD18, VD10)	25
Table 9: Protection Mode (VL25)	25
Table 10: Protection Mode (VS33).....	25
Table 11: SEQCNT[0] Operation Mode.....	30
Table 12: SEQCNT[1] Operation Mode.....	30
Table 13: Initializing Control Circuit.....	30
Table 14: I2C accessible condition	35
Table 15: Interruption at Primary Level	45
Table 16: Interruption at Secondary Level 2	46
Table 17: WDT setting (NG_RATIO[1:0] = "00").....	51
Table 18: WDT setting (NG_RATIO[1:0] = "01").....	51
Table 19: WDT setting (NG_RATIO[1:0] = "10").....	51
Table 20: WDT setting (NG_RATIO[1:0] = "11").....	51
Table 21: I2C I/F Register Map	53
Table 22: PMIC Internal State.....	57
Table 23: PON/POFF Trigger Signal.....	65
Table 24: PON/POFF Interval	66
Table 25: VOUT1 Tuning Voltage	67
Table 26: VOUT1 OVD Voltage	67
Table 27: VOUT1 UVD Voltage.....	68
Table 28: VOUT2 Tuning Voltage	68
Table 29: VOUT2 OVD Voltage	68
Table 30: VOUT2 UVD Voltage.....	69
Table 31: VOUT3 Tuning Voltage	69
Table 32: VOUT3 OVD Voltage	70
Table 33: VOUT3 UVD Voltage.....	70
Table 34: VOUT4 Tuning Voltage	71
Table 35: VOUT4 OVD Voltage	71
Table 36: VOUT4 UVD Voltage.....	71
Table 37: VOUTL1 Tuning Voltage	72
Table 38: VOUTL1 OVD Voltage	72
Table 39: VOUTL1 UVD Voltage.....	72
Table 40: VOUTS1 OCW Current(Internal) and Voltage(External)	73
Table 41: VOUTS1 OCP Current(Internal) and Voltage(External)	73
Figure 1. An Example of Signal Line Diagram for PMIC	14
Figure 2. Application Circuit.....	15
Figure 3. Application Circuit (External MOS)	15
Figure 4. RSTB Operation Timing Chart.....	27
Figure 5. Output Power-ON Operation Timing Chart (Default Register Setting)	28
Figure 6. Output Power-OFF Operation Timing Chart (Default Register Setting)	28
Figure 7. VOUT2 Discharge Start Timing	29
Figure 8. SEQCNT Circuit	30
Figure 9. Whole Sequence1 (Mode B).....	31
Figure 10. Whole Sequence2 (Mode B).....	31
Figure 11. Error Case (Mode B).....	32
Figure 12. Main State Machine	33
Figure 13. Sub State Machine	34
Figure 14. Whole Sequence (State Chart).....	35
Figure 15. Sequence at Protection Error Occurrence (Timing Chart)	36
Figure 16. VOUT1 Disable Setting without EEPROM.....	37
Figure 17. VOUTL1 Disable Setting without EEPROM.....	37
Figure 18. VOUT1, VOUTL1 OFF Circuit	37
Figure 19. VOUTS1 Disable Setting without EEPROM	38
Figure 20. VOUTS1 Internal/External Setting	38
Figure 21. VOUTS1 OFF Circuit and SW Mode Selection.....	38
Figure 22. I2C Basic Protocol.....	39
Figure 23. I2C Protocol (Each Access Mode).....	39
Figure 24. I2C Protocol (FuSa Mode).....	40
Figure 25. I2C Data Format (FuSa Mode type2 = ECC at Calculation)	42
Figure 26. Error Detection Judgement by ECC Calculation.....	42
Figure 27. Error Correction Calculation	42

Figure 28. Interruption Factor/Mask/Request	43
Figure 29. Interrupt Function Description	43
Figure 30. System Diagram of Interruption Function	44
Figure 31. Power Abnormality Monitoring Circuit	47
Figure 32. Timing Chart when Protection Error Factor Occur 1	47
Figure 33. Timing Chart when Protection Error Factor Occur 2	48
Figure 34. Timing Chart when Protection Detection Factor Occur	48
Figure 35. WDT Function	50
Figure 36. WDT NG RATIO	50
Figure 37. WDT Detection Time when NG_RATIO[1:0] = "00"	52
Figure 38. WDT Detection Time when NG_RATIO[1:0] = "01"	52
Figure 39. Modulation Waveform of SSCG	55
Figure 40. VOUT1 Output Voltage vs VIN	75
Figure 41. VOUT2 Output Voltage vs VIN	75
Figure 42. VOUT3 Output Voltage vs VIN (VOUT3 = 1.35 V Setting)	75
Figure 43. VOUT3 Output Voltage vs VIN (VOUT3 = 1.5 V Setting)	75
Figure 44. VOUT4 Output Voltage vs VIN	76
Figure 45. VOUTL1 Output Voltage vs VIN	76
Figure 46. VOUT1 Output Voltage vs IOUT	77
Figure 47. VOUT2 Output Voltage vs IOUT	77
Figure 48. VOUT3 Output Voltage vs IOUT (VOUT3 = 1.35 V Setting)	77
Figure 49. VOUT3 Output Voltage vs IOUT (VOUT3 = 1.5 V Setting)	77
Figure 50. VOUT4 Output Voltage vs IOUT	78
Figure 51. VOUTL1 Output Voltage vs IOUT	78
Figure 52. VOUT1 Power Efficiency vs IOUT	79
Figure 53. VOUT2 Power Efficiency vs IOUT	79
Figure 54. VOUT3 Power Efficiency vs IOUT (VOUT3 = 1.35 V Setting)	79
Figure 55. VOUT3 Power Efficiency vs IOUT (VOUT3 = 1.5 V Setting)	79
Figure 56. VOUT4 Power Efficiency vs IOUT	80
Figure 57. VOUT1 Power ON Waveform	81
Figure 58. VOUT2 Power ON Waveform	81
Figure 59. VOUT3 Power ON Waveform (VOUT3 = 1.35 V Setting)	81
Figure 60. VOUT3 Power ON Waveform (VOUT3 = 1.5 V Setting)	81
Figure 61. VOUT4 Power ON Waveform	82
Figure 62. VOUTL1 Power ON Waveform	82
Figure 63. VOUTS1 Power ON Waveform	82
Figure 64. VOUT1 Power OFF Waveform	83
Figure 65. VOUT2 Power OFF Waveform	83
Figure 66. VOUT3 Power OFF Waveform (VOUT3 = 1.35 V Setting)	83
Figure 67. VOUT3 Power OFF Waveform (VOUT3 = 1.5 V Setting)	83
Figure 68. VOUT4 Power OFF Waveform	84
Figure 69. VOUTL1 Power OFF Waveform	84
Figure 70. VOUTS1 Power OFF Waveform	84
Figure 71. VOUT1 Load Transient (IOUT = 0 A to 100 mA (SR = 100 mA/μs))	85
Figure 72. VOUT2 Load Transient (IOUT = 0 A to 0.5 A (SR = 1 A/μs))	85
Figure 73. VOUT3 Load Transient (VOUT3 = 1.35 V Setting, IOUT = 0 A to 1 A (SR = 1 A/μs))	85
Figure 74. VOUT3 Load Transient (VOUT3 = 1.5 V Setting, IOUT = 0 A to 1 A (SR = 1 A/μs))	85
Figure 75. VOUT4 Load Transient (IOUT = 0 A to 2.05 A (SR = 1 A/μs))	86
Figure 76. VOUTL1 Load Transient (IOUT = 0 A to 75 mA (SR = 100 mA/μs))	86
Figure 77. Example of Monolithic IC Structure	88

1. Device Feature

1.1 Output Voltage Table

Table 1: Output Voltage Table of Each State

Channel	Rail name	Output [V]	I _{max} [A]	STANDBY	ACTIVE
VD50	VOUT1	5.0	0.2	OFF	ON
VD18	VOUT2	1.8	1.0	OFF	ON
DDR	VOUT3	1.35 (DDR3L) 1.50 (DDR3)	2.0	OFF	ON
VD10A VD10B	VOUT4	1.03	5.2	OFF	ON
VL25	VOUTL1	2.5	0.15	OFF	ON
VS33	VOU1S1	VIN7 (Analog Switch)	0.3	OFF	ON

1. Device Feature – continued

1.2 Signal Line Diagram for PMIC

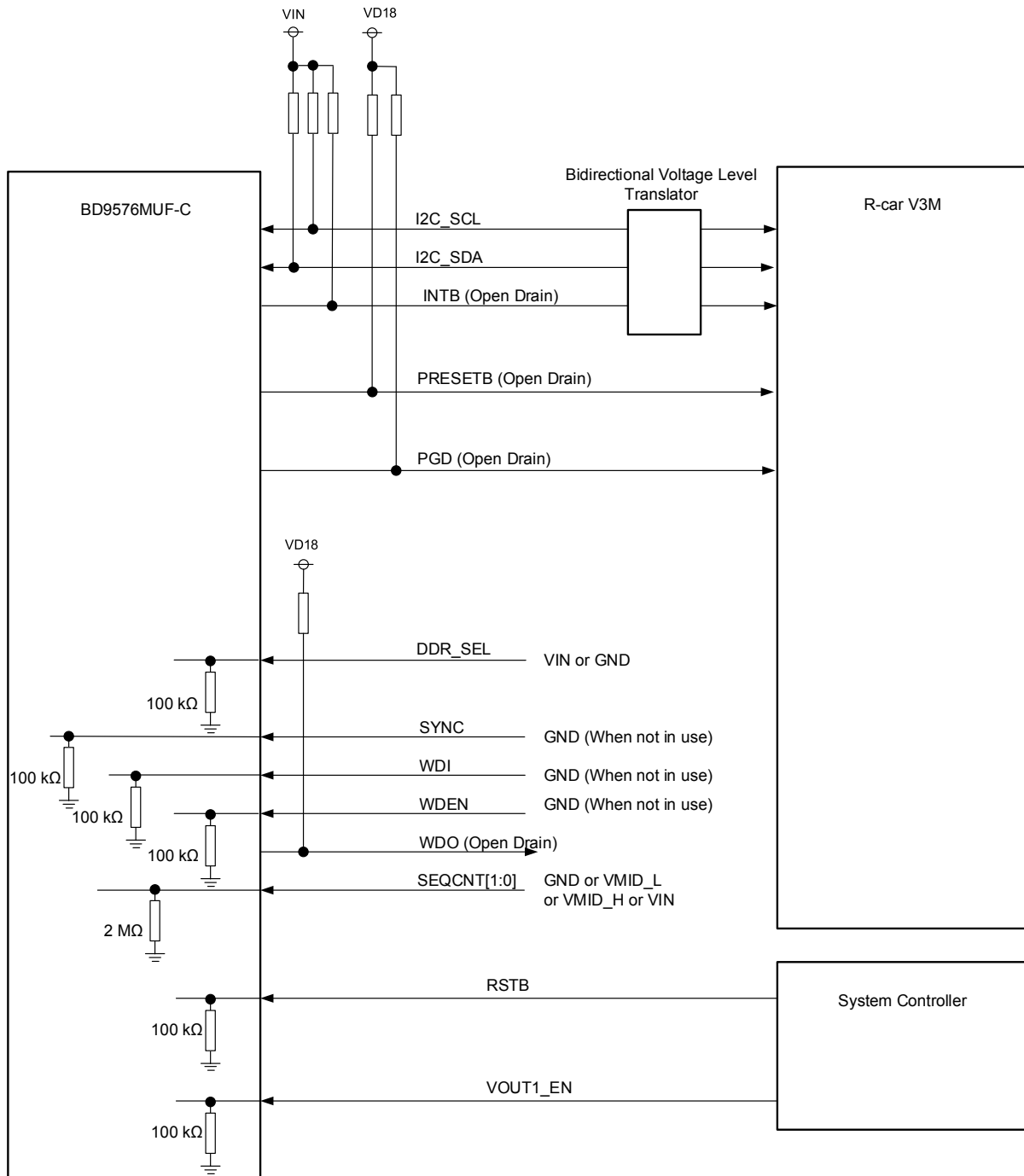

Figure 1. An Example of Signal Line Diagram for PMIC

2. Application

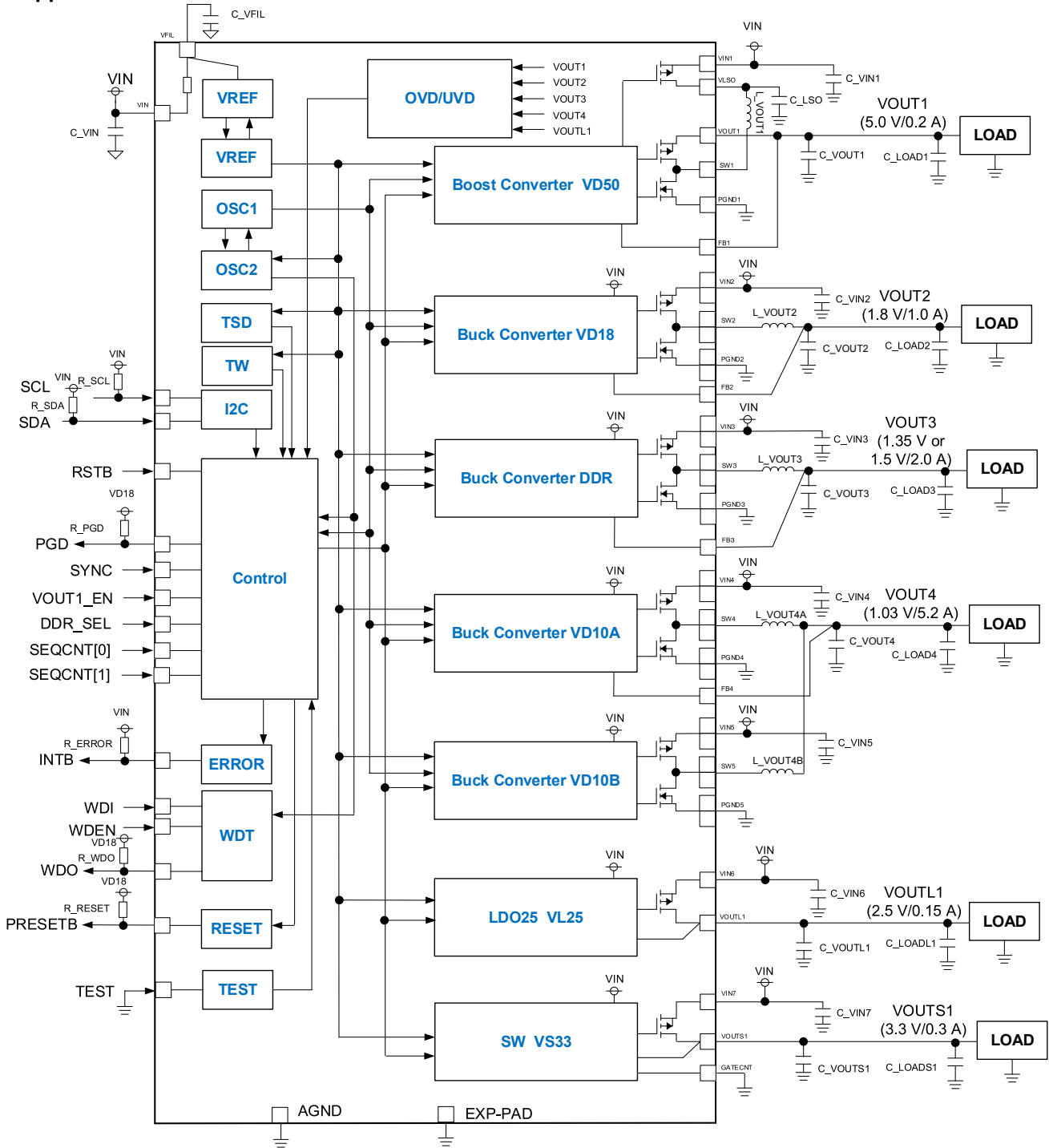

Figure 2. Application Circuit

Figure 3 shows the case of external FET for VOUTS1. When VOUTS1 uses it in 0.3 A or more, use it with external FET.

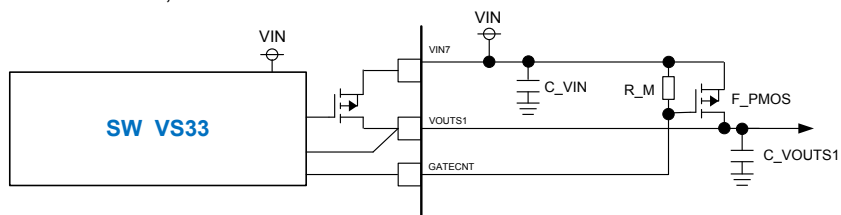

Figure 3. Application Circuit (External MOS)

2. Application - continued

Table 2: Application Circuit Components List

Parts Name	Value			Unit	Vendor	Parts Number	Size (mm)
	Min ^(Note 1)	Typ	Max				
C_VINx	-	10	-	μF	MURATA	GCM21BR70J106KE22	2012
C_VFIL	-	1	-	μF	MURATA	GCM188R71C105KA64	1608
C_LSO	-	10 x 2	-	μF	MURATA	GCM21BR70J106KE22	2012
C_VOUT1	-	22	-	μF	MURATA	GCM31CR71A226KE02	3216
C_LOAD1	22	-	-	μF	MURATA	GCM31CR71A226KE02	3216
L_VOUT1	-	2.2	-	μH	TDK	TFM252012ALMA2R2MTAA	2520
L_VOUT2	-	0.22	-	μH	TDK	TFM252012ALMAR22MTAA	2520
C_VOUT2	-	22	-	μF	MURATA	GCM31CR70J226KE26	3216
	-	or 22	-	μF	TDK	CGA4J1X7T0J226M	2012
C_LOAD2	22 x 2	-	-	μF	MURATA	GCM31CR70J226KE26	3216
	or 22 x 2	-	-	μF	TDK	CGA4J1X7T0J226M	2012
L_VOUT3	-	0.33	-	μH	TDK	TFM252012ALMAR33MTAA	2520
C_VOUT3	-	22	-	μF	MURATA	GCM31CR70J226KE26	3216
	-	or 22	-	μF	TDK	CGA4J1X7T0J226M	2012
C_LOAD3	22 x 3	-	-	μF	MURATA	GCM31CR70J226KE26	3216
	or 22 x 3	-	-	μF	TDK	CGA4J1X7T0J226M	2012
L_VOUT4A	-	0.22	-	μH	TDK	TFM252012ALMAR22MTAA	2520
L_VOUT4B	-	0.22	-	μH	TDK	TFM252012ALMAR22MTAA	2520
C_VOUT4	-	47 x 2	-	μF	MURATA	GCM32ER70J476KE19	3225
	-	or 22 x 4	-	μF	TDK	CGA4J1X7T0J226M	2012
C_LOAD4	47 x 4	-	-	μF	MURATA	GCM32ER70J476KE19	3225
	or 22 x 8	-	-	μF	TDK	CGA4J1X7T0J226M	2012
C_VOUTL1	-	10	-	μF	MURATA	GCM21BR70J106KE22	2012
C_LOADL1	1	-	300	μF	-	-	-
C_VOUTS1	-	10	-	μF	MURATA	GCM21BR70J106KE22	2012
C_LOADS1	1	-	300	μF	-	-	-
F_PMOS	-	-	-	-	ROHM	RQ1A070ZPHZG	TSMT8
R_M	-	100	-	kΩ	ROHM	MCR01MZPF1003	1005
R_PG D	-	10	-	kΩ	ROHM	MCR01MZPF1002	1005
R_EEROR	-	10	-	kΩ	ROHM	MCR01MZPF1002	1005
R_RESET	-	10	-	kΩ	ROHM	MCR01MZPF1002	1005
R_SDA	-	1	-	kΩ	ROHM	MCR01MZPF1001	1005
R_SCL	-	1	-	kΩ	ROHM	MCR01MZPF1001	1005
R_WDO	-	10	-	kΩ	ROHM	MCR01MZPF1002	1005

(Note 1) Please set in consideration of temperature properties and DC bias properties not to become less than the minimum.
Please consider it based on enough evaluations with the actual model.

3. Electrical Characteristics

3.1 Absolute Maximum Ratings

Table 3: Absolute Maximum Ratings

Parameter	Symbol	Rating	Unit
Input Voltage 1	VIN, VIN1, VIN2, VIN3, VIN4, VIN5, VIN6, VIN7	-0.3 to +7.0	V
Input Voltage 2	FB1, FB2, FB3, FB4	-0.3 to +7.0	V
Output Voltage 1	VFIL	-0.3 to VIN+0.3	V
Output Voltage 2	VLSO	-0.3 to VIN1+0.3	V
Output Voltage 3	VOUT1	-0.3 to +7.0	V
Output Voltage 4	VOUTL1, VOUTS1	-0.3 to VINx+0.3	V
Output Voltage 5	GATECNT	-0.3 to +7.0	V
SW to GND Voltage 1	SW2, SW3, SW4, SW5	-0.3 to VINx+0.3	V
SW to GND Voltage 2	SW1	-0.3 to +10.0	V
Logic Input Voltage 1	RSTB, SDA, SCL	-0.3 to +7.0	V
Logic Input Voltage 2	SYNC, WDI, WDEN, VOUT1_EN, DDR_SEL	-0.3 to VIN+0.3	V
Logic Input Voltage 3	SEQCNT[0], SEQCNT[1]	-0.3 to VIN+0.3	V
Logic Output Voltage 1	INTB, PGD, WDO	-0.3 to +7.0	V
Logic Output Voltage 2	PRESETB	-0.3 to VIN+0.3	V
Logic Output Pin Current Low 1	PRESETB, INTB, PGD, WDO	-3.0	mA
Logic Output Pin Current Low 2	SDA, SCL	-20.0	mA
Storage Temperature Range	Tstg	-55 to +150 ^(Note 1)	°C
Maximum Junction Temperature	Tjmax	150	°C

Caution 1: Operating the IC over the absolute maximum ratings may damage the IC. The damage can either be a short circuit between pins or an open circuit between pins and the internal circuitry. Therefore, it is important to consider circuit protection measures, such as adding a fuse, in case the IC is operated over the absolute maximum ratings.

Caution 2: Should by any chance the maximum junction temperature rating be exceeded the rise in temperature of the chip may result in deterioration of the properties of the chip. In case of exceeding this absolute maximum rating, design a PCB with thermal resistance taken into consideration by increasing board size and copper area so as not to exceed the maximum junction temperature rating.

(Note 1) Operation is not guaranteed.

3. Electrical Characteristics - continued

3.2 Thermal Resistance^(Note 1)

Parameter	Symbol	Thermal Resistance (Typ)		Unit
		1s ^(Note 3)	2s2p ^(Note 4)	
VQFN56FV8080				
Junction to Ambient	θ_{JA}	59.8	22.2	°C/W
Junction to Top Characterization Parameter ^(Note 2)	Ψ_{JT}	4.0	2.0	°C/W

(Note 1) Based on JE51-2A (Still-Air).

(Note 2) The thermal characterization parameter to report the difference between junction temperature and the temperature at the top center of the outside surface of the component package.

(Note 3) Using a PCB board based on JE51-3.

(Note 4) Using a PCB board based on JE51-5, 7.

Layer Number of Measurement Board	Material	Board Size
Single	FR-4	114.3 mm x 76.2 mm x 1.57 mmt

Top	
Copper Pattern	Thickness
Footprints and Traces	70 μ m

Layer Number of Measurement Board	Material	Board Size	Thermal Via ^(Note 5)	
			Pitch	Diameter
4 Layers	FR-4	114.3 mm x 76.2 mm x 1.6 mmt	1.20 mm	Φ 0.30 mm

Top		2 Internal Layers		Bottom	
Copper Pattern	Thickness	Copper Pattern	Thickness	Copper Pattern	Thickness
Footprints and Traces	70 μ m	74.2 mm x 74.2 mm	35 μ m	74.2 mm x 74.2 mm	70 μ m

(Note 5) This thermal via connects with the copper pattern of all layers.

3. Electrical Characteristics - continued

3.3 Recommended Operating Conditions

Table 4: Recommended Operating Conditions

Parameter	Symbol	Min	Typ	Max	Unit
Power Supply Voltage	VIN	3.0	3.3	3.6	V
Power Supply Voltage 1	VIN1	3.0	3.3	3.6	V
Power Supply Voltage 2	VIN2	3.0	3.3	3.6	V
Power Supply Voltage 3	VIN3	3.0	3.3	3.6	V
Power Supply Voltage 4	VIN4	3.0	3.3	3.6	V
Power Supply Voltage 5	VIN5	3.0	3.3	3.6	V
Power Supply Voltage 6	VIN6	3.0	3.3	3.6	V
Power Supply Voltage 7	VIN7	3.0	3.3	3.6	V
Logic Input Voltage Low 1	RSTB, SYNC, WDI, WDEN, VOUT1_EN, DDR_SEL	-0.3	-	+0.5	V
Logic Input Voltage High 1	RSTB, SYNC, WDI, WDEN, VOUT1_EN, DDR_SEL	1.2	-	VIN + 0.3	V
Logic Input Voltage Low 2	SCL, SDA	-0.3	-	+0.5	V
Logic Input Voltage High 2	SCL, SDA	1.2	-	VIN + 0.3	V
Input Voltage Low 3	SEQCNT[0], SEQCNT[1]	-0.3	-	VIN x 0.1	V
Input Voltage Middle Low 3	SEQCNT[0], SEQCNT[1]	VIN x 0.2	-	VIN x 0.5	V
Input Voltage Middle High 3	SEQCNT[0], SEQCNT[1]	VIN x 0.6	-	VIN x 0.8	V
Input Voltage High 3	SEQCNT[0], SEQCNT[1]	VIN x 0.9	-	VIN + 0.3	V
SYNC Input Frequency Range	SYNC	1.8	2.0	2.2	MHz
SYNC Input Pulse Duty Range	SYNC	45	50	55	%
Operating Ambient Temperature	Ta	-40	25	+125	°C
Operating Junction Temperature	Tj	-40	25	+150	°C

3. Electrical Characteristics - continued

3.4 DC Characteristics

Table 5: DC Characteristics (Unless otherwise specified, Tj = -40 °C to +150 °C, VIN = 3.3 V)

Parameter	Symbol	Standard Value			Unit	Conditions
		Min	Typ	Max		
[General]						
Bias Current 1	ICC_1	-	0.5	-	mA	STANDBY (VIN, VIN1 to VIN7 total)
Bias Current 2	ICC_2	-	6	12	mA	ACTIVE (VIN, VIN1 to VIN7 total, Switching stop)
VFIL UVLO Threshold Voltage	VFIL_UVLO	2.7	2.8	2.9	V	VFIL: Sweep down
VFIL UVLO Hysteresis Voltage	dVFIL_UVLO	-	0.1	-	V	VFIL: Sweep up
VIN1 to VIN7 UVP Threshold Voltage	VIN1-7_UVP	2.6	2.7	2.8	V	VIN1 to VIN7: Sweep down
VIN1 to VIN7 UVP Hysteresis Voltage	dVIN1-7_UVP	-	0.1	-	V	VIN1 to VIN7: Sweep up
VFIL Resistance	R_VFIL	-	10	-	Ω	-
[VOUT1 (VD50)]						
Output Voltage	VOUT1	4.91	5.00	5.09	V	Io = 0 mA
Switching Frequency	Fosc_VOUT1	1.912	2.250	2.588	MHz	SSCG = OFF
Synchronization Frequency	Fsync_VOUT1	1.8	2.0	2.2	MHz	SYNC = 2 MHz
Soft-Start Time Rate	Tssr_VOUT1	-	4.2	-	V/ms	VIN to VOUT1 (DCDC converter Soft-start time rate)
VOUT1 Soft Start Time	Tss_VOUT1	-	1.57	-	ms	0 V to 5 V (Include LDSW on time)
Upper-Side ON Resistance	Ronh_VOUT1	-	250	500	mΩ	-
Lower-Side ON Resistance	Rohl_VOUT1	-	200	400	mΩ	-
Over Current Protection	OCP_VOUT1	1.2	-	-	A	Detect a peak current flowing in Low-side FET
SCP Detecting Voltage	SCP_VOUT1	VOUT1 x 0.7	VOUT1 x 0.8	VOUT1 x 0.9	V	-
OVP Detecting Voltage	OVP_VOUT1	VOUT1 x 1.13	VOUT1 x 1.20	VOUT1 x 1.27	V	-
Load Switch ON Resistance	Ron_LS	-	200	400	mΩ	-
Load Switch Over Current Protection	OCP_LDSW	2.2	-	-	A	-
OVD Detecting Voltage	OVD_VOUT1	273	342	410	mV	Compared to VOUT1 voltage level
UVD Detecting Voltage	UVD_VOUT1	-410	-342	-273	mV	Compared to VOUT1 voltage level
Output Discharge Resistance	Rdis_VOUT1	-	25	50	Ω	VOUT1 Discharge

3.4 DC Characteristics – continued

(Unless otherwise specified, Tj = -40 °C to +150 °C, VIN = 3.3 V)

Parameter	Symbol	Standard Value			Unit	Conditions
		Min	Typ	Max		
[VOUT2 (VD18)]						
Output Voltage	VOUT2	1.7676	1.8000	1.8324	V	Io = 0 mA
Switching Frequency	Fosc_VOUT2	1.912	2.250	2.588	MHz	SSCG = OFF
Synchronization Frequency	Fsync_VOUT2	1.8	2.0	2.2	MHz	SYNC = 2 MHz
Soft-Start Time Rate	Tss_VOUT2	-	1.0	-	V/ms	-
Upper-Side ON Resistance	Ronh_VOUT2	-	160	320	mΩ	-
Lower-Side ON Resistance	Rohl_VOUT2	-	100	200	mΩ	-
Over Current Protection	OCP_VOUT2	2.5	-	-	A	Detect a peak current flowing in High-side FET
SCP Detecting Voltage	SCP_VOUT2	VOUT2 x 0.73	VOUT2 x 0.80	VOUT2 x 0.87	V	-
OVP Detecting Voltage	OVP_VOUT2	VOUT2 x 1.13	VOUT2 x 1.20	VOUT2 x 1.27	V	-
OVD Detecting Voltage	OVD_VOUT2	45.1	56.0	67.6	mV	Compared to VOUT2 voltage level
UVD Detecting Voltage	UVD_VOUT2	-67.6	-56.0	-45.1	mV	Compared to VOUT2 voltage level
Output Discharge Resistance	Rdis_VOUT2	20	55	150	Ω	FB2 Discharge
[VOUT3 (DDR)]						
Output Voltage 1	VOUT3_1	1.3257	1.3500	1.3743	V	Io = 0 mA DDR_SEL = L
Output Voltage 2	VOUT3_2	1.473	1.500	1.527	V	Io = 0 mA DDR_SEL = H
Switching Frequency	Fosc_VOUT3	1.912	2.250	2.588	MHz	SSCG = OFF
Synchronization Frequency	Fsync_VOUT3	1.8	2.0	2.2	MHz	SYNC = 2 MHz
Soft-Start Time Rate	Tss_VOUT3	-	1.0	-	V/ms	-
Upper-Side ON Resistance	Ronh_VOUT3	-	100	200	mΩ	-
Lower-Side ON Resistance	Rohl_VOUT3	-	70	140	mΩ	-
Over Current Protection	OCP_VOUT3	3.6	-	-	A	Detect a peak current flowing in High-side FET
SCP Detecting Voltage	SCP_VOUT3	VOUT3 x 0.73	VOUT3 x 0.80	VOUT3 x 0.87	V	-
OVP Detecting Voltage	OVP1_VOUT3	VOUT3 x 1.13	VOUT3 x 1.20	VOUT3 x 1.27	V	-
OVD Detecting Voltage 1	OVD1_VOUT3	50.5	63.0	75.7	mV	DDR_SEL = L Compared to VOUT3 voltage level
OVD Detecting Voltage 2	OVD2_VOUT3	32	40	48	mV	DDR_SEL = H Compared to VOUT3 voltage level
UVD Detecting Voltage 1	UVD1_VOUT3	-42.7	-36.0	-28.5	mV	DDR_SEL = L Compared to VOUT3 voltage level
UVD Detecting Voltage 2	UVD2_VOUT3	-48	-40	-32	mV	DDR_SEL = H Compared to VOUT3 voltage level
Output Discharge Resistance	Rdis_VOUT3	20	40	80	Ω	FB3 Discharge

3.4 DC Characteristics – continued

(Unless otherwise specified, Tj = -40 °C to +150 °C, VIN = 3.3 V)

Parameter	Symbol	Standard Value			Unit	Conditions
		Min	Typ	Max		
[VOUT4 (VD10A, VD10B)]						
Output Voltage	VOUT4	1.0115	1.0300	1.0485	V	Io = 0 mA
Switching Frequency	Fosc_VOUT4	1.912	2.250	2.588	MHz	SSCG = OFF
Synchronization Frequency	Fsync_VOUT4	1.8	2.0	2.2	MHz	SYNC = 2 MHz
Soft-Start Time Rate	Tss_VOUT4	-	1.0	-	V/ms	-
Upper-Side ON Resistance	Ronh_VOUT4A Ronh_VOUT4B	-	100	200	mΩ	-
Lower-Side ON Resistance	Rohl_VOUT4A Rohl_VOUT4B	-	70	140	mΩ	-
Over Current Protection	OCP_VOUT4A OCP_VOUT4B	3.6	-	-	A	Detect a peak current flowing in High-side FET
SCP Detecting Voltage	SCP_VOUT4	VOUT4 x 0.73	VOUT4 x 0.80	VOUT4 x 0.87	V	-
OVP Detecting Voltage	OVP_VOUT4	VOUT4 x 1.07	VOUT4 x 1.14	VOUT4 x 1.21	V	-
OVD Detecting Voltage	OVD_VOUT4	21.0	26.0	31.5	mV	Compared to VOUT4 voltage level
UVD Detecting Voltage	UVD_VOUT4	-31.5	-26.0	-21.0	mV	Compared to VOUT4 voltage level
Output Discharge Resistance	Rdis_VOUT4	15	30	60	Ω	FB4 Discharge

3.4 DC Characteristics – continued

(Unless otherwise specified, Tj = -40 °C to +150 °C, VIN = 3.3 V)

Parameter	Symbol	Standard Value			Unit	Conditions
		Min	Typ	Max		
[VOUTL1 (VL25)]						
Output Voltage	VOUTL1	2.455	2.500	2.545	V	Io = 0 mA
Soft-Start Time Rate	Tss_VOUTL1	-	1.0	-	V/ms	-
ON Resistance	Ron_VOUTL1	-	-	2	Ω	I _{ds} = 50 mA
Over Current Protection	OCP_VOUTL1	350	-	-	mA	-
SCP Detecting Voltage	SCP_VOUTL1	VOUTL1 x 0.73	VOUTL1 x 0.80	VOUTL1 x 0.87	V	-
OVP Detecting Voltage	OVP_VOUTL1	VOUTL1 x 1.13	VOUTL1 x 1.20	VOUTL1 x 1.27	V	-
OVD Detecting Voltage	OVD_VOUTL1	103	129	155	mV	Compared to VOUTL1 voltage level
UVD Detecting Voltage	UVD_VOUTL1	-155	-129	-103	mV	Compared to VOUTL1 voltage level
Output Discharge Resistance	Rdis_VOUTL1	75	150	300	Ω	VOUTL1 Discharge
[VOUTS1 (VS33)]						
Soft-Start Time Rate	Tss_VOUTS1	-	1	-	V/ms	-
SW OCW Detecting Current (Internal)	OCW_VOUTS1_IN	390	-	-	mA	-
SW OCP-OCW difference Detecting Voltage (External)	ΔOCW_ VOUTS1_EX	1	20	50	mV	ΔV = OCP_VOUTS1_EX - OCW_VOUTS1_EX
Output Discharge Resistance	Rdis_VOUTS1	15	30	50	Ω	VOUTS1 Discharge
SW ON Resistance	Ron_VOUTS1	100	250	450	mΩ	-
GATECNT ON Resistance	Ron_GATECNT	10	25	50	Ω	GATECNT = 0.5 V
GATECNT Pull Up Resistance	Rup_GATECNT	-	2	-	MΩ	-
SW OCP Detecting Current (Internal)	OCP_VOUTS1_IN	510	-	-	mA	-
SW OCP Detecting Voltage (External)	OCP_VOUTS1_EX	60	90	120	mV	ΔV = VIN7 - VOUTS1

3.4 DC Characteristics – continued

Table 6: Logic Characteristics (Unless otherwise specified, Tj = -40 °C to +150 °C, VIN = 3.3 V)

Parameter	Symbol	Standard Value			Unit	Conditions
		Min	Typ	Max		
[Logic Block]						
[Logic Input 1] (RSTB, SYNC, WDI, WDEN, VOUT1_EN, DDR_SEL)						
Input Voltage Low 1	VIL1	-0.3	-	+0.5	V	-
Input Voltage High 1	VIH1	1.2	-	VIN + 0.3	V	-
Pull Down Resistance 1	RIN1	-	100	-	kΩ	-
[Logic Input 2] (SDA, SCL)						
Input Voltage Low 2	VIL2	-0.3	-	+0.5	V	-
Input Voltage High 2	VIH2	1.2	-	VIN + 0.3	V	-
Input Current 2	IIN2	-1	0	+1	μA	-
Acknowledge ON Voltage	VACK	-0.3	-	+0.4	V	Iload = -20 mA
[Logic Input 3] (SEQCNT[0], SEQCNT[1])						
Input Voltage Low 3	VIL3	-0.3	-	VIN x 0.1	V	-
Input Voltage Middle Low 3	VIML3	VIN x 0.2	-	VIN x 0.5	V	-
Input Voltage Middle High 3	VIMH3	VIN x 0.6	-	VIN x 0.8	V	-
Input Voltage High 3	VIH3	VIN x 0.9	-	VIN + 0.3	V	-
Pull Down Resistance 3	RIN3	-	2	-	MΩ	-
[Logic Output Voltage Low 1] (Open Drain Output)						
INTB, PGD, WDO	Logic_out_low1	-0.3	-	+0.7	V	Iload = -3 mA
[Logic Output Voltage Low 2] (Open Drain Output)						
PRESETB	Logic_out_low2	-0.3	-	+0.5	V	Iload = -3 mA

3. Electrical Characteristics - continued

3.5 Protection Mode (Under Voltage Lock Out)

All power supply shuts down at the same time when the VFIL UVLO signal is detected. There is no sequence in this shutdown mode and the BD9576MUF-C cannot receive any external signals during this time.

3.6 Protection Mode (Thermal Shutdown)

Built-in internal Thermal Shutdown (TSD) circuit is provided to protect IC from heat destruction. Operation usage should stay within the allowable loss range. Continuous use beyond this range can cause chip temperature T_j to increase and consequently activate the TSD circuit. Threshold is 175 °C (Typ). TSD over 10 μ s shuts down all power supplies at the same time. Please consider the set design not to exceed TSD for safety use.

3.7 Protection Mode (Thermal Warning)

Built-in internal Thermal Warning (TW) circuit is provided to protect the IC from heat destruction. Thermal Warning (TW) is detected 30 °C lower than Thermal Shutdown (TSD). Thermal Warning (TW) is notified by the INTB pin negation.

3.8 Protection Mode

Table 7: Protection Mode (General)

Protection Mode	SW	Output	Function
UVLO Protection (VFIL)	Hi-Z	Low (Discharge)	PMIC is shut down immediately. All registers are reset.
Thermal Shutdown	Hi-Z	Low (Discharge)	PMIC is shut down immediately. Some registers (SEQ reset Register) are reset.

Table 8: Protection Mode (VD50, DDR, VD18, VD10)

Protection Mode	SW	Output	Function
Under Voltage Protection[UVP] (VIN1 to VIN5) ^(Note 1)	Hi-Z	Low (Discharge)	PMIC is shut down immediately. Some registers (SEQ reset Register) are reset.
Short Circuit Protection	Hi-Z	Low (Discharge)	Timer latch (1 ms). PMIC is shut down. Some registers (SEQ reset Register) are reset.
Over Voltage Protection	Hi-Z	Low (Discharge)	PMIC is shut down immediately. Some registers (SEQ reset Register) are reset.
Over Current Protection	Hi-Z	Low (Discharge)	Duty is restricted. Timer latch (1 ms). PMIC is shut down. Some registers (SEQ reset Register) are reset.

(Note 1) VOUT1 or VOUTL1 output can be set to disable by connecting the VIN1 pin or the VIN6 pin to GND.
Please refer to section 4.3 VOUT1/VOUTL1 Disable Setting without EEPROM.

Table 9: Protection Mode (VL25)

Protection Mode	Output	Function
Under Voltage Protection[UVP] (VIN6) ^(Note 1)	Low (Discharge)	PMIC is shut down immediately. Some registers (SEQ reset Register) are reset.
Short Circuit Protection	Low (Discharge)	Timer latch (1 ms). PMIC is shut down. Some registers (SEQ reset Register) are reset.
Over Voltage Protection	Low (Discharge)	PMIC is shut down immediately. Some registers (SEQ reset Register) are reset.

(Note 1) VOUT1 or VOUTL1 output can be set to disable by connecting the VIN1 pin or the VIN6 pin to GND.
Please refer to section 4.3 VOUT1/VOUTL1 Disable Setting without EEPROM.

Table 10: Protection Mode (VS33)

Protection Mode	Output	Function
Under Voltage Protection[UVP] (VIN7)	Low (Discharge)	PMIC is shut down immediately. Some registers (SEQ reset Register) are reset.
Over Current Protection	Low (Discharge)	Timer latch (1 ms). PMIC is shut down. Some registers (SEQ reset Register) are reset.

3.9 Mutual Monitor Function (VREF, OSC)

There are 2 blocks of OSC and VREF respectively, and those are being monitored mutually. When Mutual Monitor Function error occurs, shuts down all power supplies at the same time.

4. Function Description

4.1 Pin Control Function

4.1.1 VOUT1_EN Input

VOUT1 Mode is selected by VOUT1_EN (pin) condition at UVLO release timing.

At the judgement timing, VOUT1 output voltage is

Mode A: controlled sequentially by the register setting. (VOUT1_EN (pin) = H at UVLO release timing).

Mode B: controlled by VOUT1_EN (pin) individually, and register setting is ignored.

(VOUT1_EN (pin) = L at UVLO release timing).

(Note) Most of timing charts in this data sheet are based on Mode A. Regarding Mode B, please refer to section 4.1.9 VOUT1 Mode Setting.

4.1.2 RSTB Input

The RSTB pin input is control signal to start Output Power-ON / Output Power-OFF.

Output Power-ON starts by inputting RSTB = H level and Output Power-OFF starts by inputting RSTB = L level.

Between the completion of Output Power-OFF and beginning of Output Power-ON (STANDBY state), internal functions (except particular functions) are initialized and stops the circuit oscillator for low power consumption with OSC_EN register = "0" setting.

Even though in STANDBY state, circuit oscillation starts with OSC_EN register = "1" setting.

(Note) In case RSTB = L level is detected during Power-ON Sequence, Power-OFF sequence starts immediately.

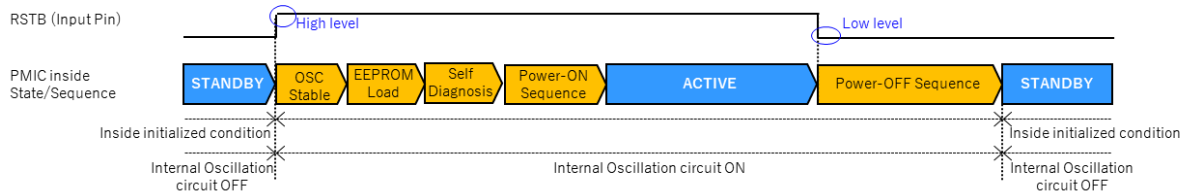

Figure 4. RSTB Operation Timing Chart

4.1.3 PIN Setting Judge Timing

The SEQCNT[1:0] pin (Select Power-ON / Power-OFF interval) and the DDR_SEL pin (select DDR output voltage) settings are judged just before EEPROM Load.

4.1 Pin Control Function – continued

4.1.4 Output Power-ON / Output Power-OFF Sequence

Output Power-ON starts by input of RSTB = H level.

In Output Power-ON operation,

(1) Internal Oscillation Operation (OSC Stable), (2) EEPROM Load, (3) Self Diagnosis and (4) Power-ON sequence are consecutively activated as shown in the following figure.

Regarding the interval T1 and T4, please refer to 4.1.7 Interval Setting.

- (1) Internal Oscillation Operation: BD9576MUF-C waits 110 μ s (Max) for stable oscillation internally.
- (2) EEPROM Load: Some of the functions can be selected by EEPROM setting value (Max 2 ms).
- (3) Self Diagnosis: BD9576MUF-C execute Self Diagnosis (Max 2 ms) before Power-ON.
- (4) Power-ON sequence: Activates Output Power-ON and PRESETB = H negate in order and with interval as in following figure. PGD is asserted when all output voltage levels are over 75 % (Typ) \times V_{OUT} .

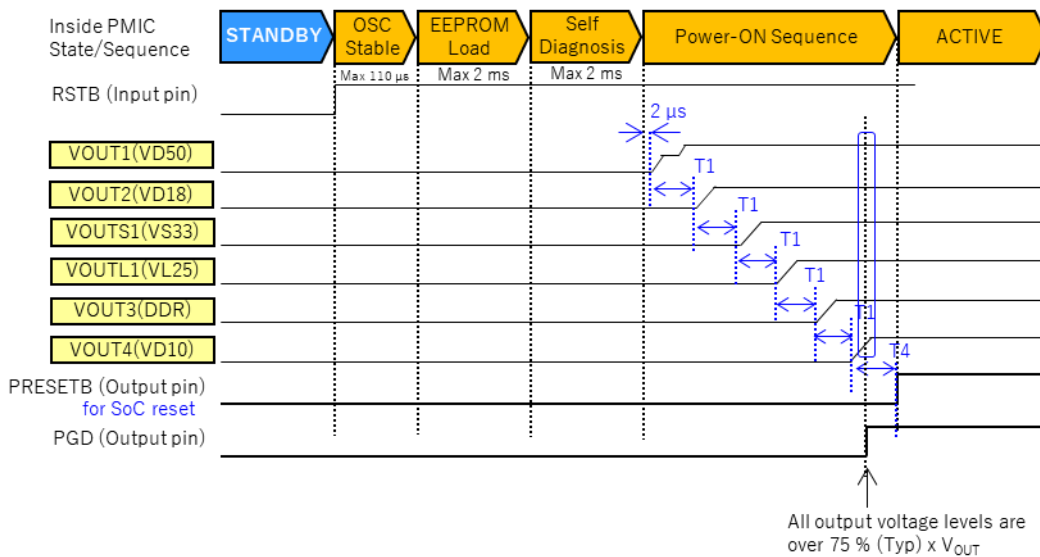

Figure 5. Output Power-ON Operation Timing Chart (Default Register Setting)

Output Power-OFF starts by input of RSTB = L level.

For Output Power-OFF operation, Power-OFF sequence activates as in following figure.

Regarding the interval T2 and T3, please refer to 4.1.7 Interval Setting.

PGD is negated when one of the output power starts discharging.

Power-OFF operation is completed when all SHDN (= output voltage levels are under 200 mV (Typ)) is asserted.

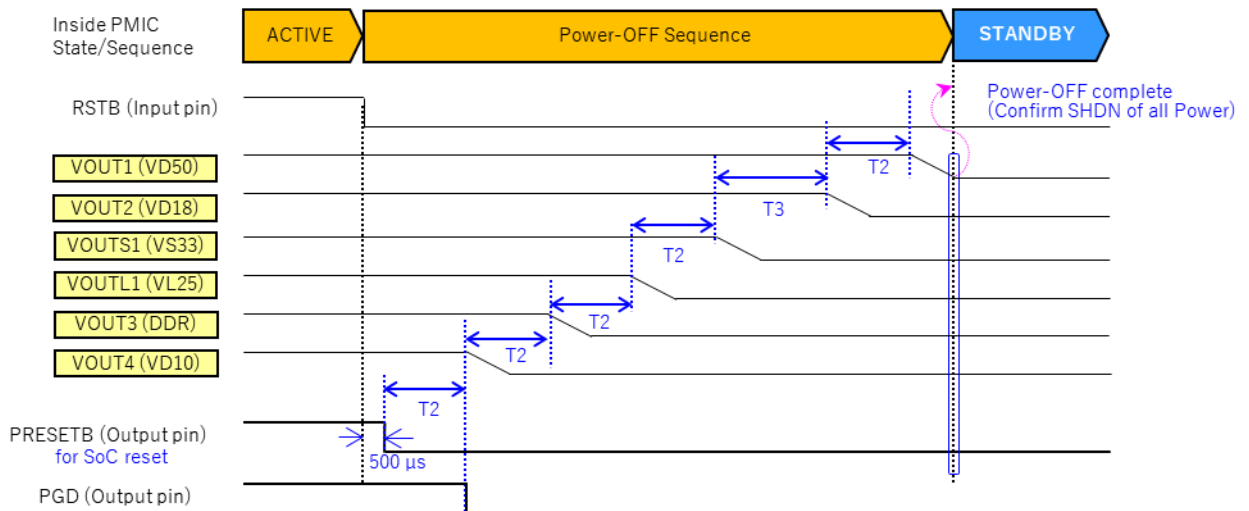

Figure 6. Output Power-OFF Operation Timing Chart (Default Register Setting)

4.1 Pin Control Function - continued

4.1.5 VOUT2 (VD18) Discharge Start Timing

In case all previous output's SHDN is not asserted after the interval T3, VOUT2 output does not start discharging until all previous output's SHDN assertion.

4.1.6 Countermeasures for Hang-Up

In case any SHDN signal keeps low (Shutdown is not detected) during Power-Off sequence, the sequence is never completed and sequence cannot shift to next. As countermeasure for this Hang-Up situation, Hang-Up Timer is implemented.

Hang-Up Timer counts the time of Power-OFF Sequence, and if it continues over 400 ms, internal state transitions to STANDBY automatically. In Mode B, VOUT1 also has Hang-Up Timer individually. If VOUT1 Power-OFF Sequence continues over 100 ms, internal state transitions to STANDBY automatically.

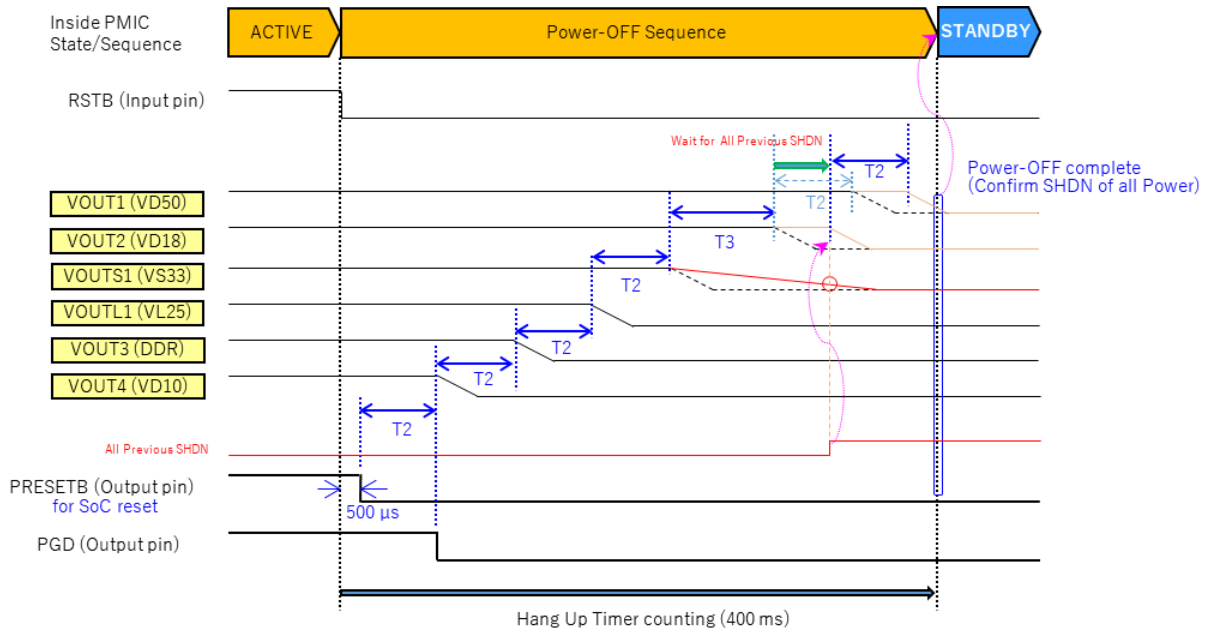

Figure 7. VOUT2 Discharge Start Timing

4.1 Pin Control Function - continued

4.1.7 Interval Setting

Regarding the interval T1, T2, T3 and T4, they are set by the voltage setting of the SEQCNT[0] pin and the SEQCNT[1] pin. The SEQCNT[1:0] pin input value is judged just before EEPROM Load. If EEPROM connection is detected in the state of EEPROM Load, interval setting by the SEQCNT[1:0] pin is discarded and the setting by EEPROM is used.

If I2C write command to POW Trigger VOUTx (VOUTx = VOUT1 to VOUT4, VOUTL1, VOUTS1) or POW Wait VOUTx registers is detected, interval setting by the SEQCNT[1:0] pin is discarded and the setting by I2C write command is used. Also in this case, by EEPROM connection interval setting by the SEQCNT[1:0] pin or I2C write command are discarded and the setting by EEPROM is used.

Table 11: SEQCNT[0] Operation Mode

SEQCNT[0]	SEQCNT[0]_DATA[2:0]	T1	T2	T4
VIN	"111"	10 ms	10 ms	25 ms
VMD_H ^(Note 1)	"011"	8 ms	8 ms	15 ms
VMD_L ^(Note 2)	"001"	4 ms	4 ms	10 ms
GND	"000"	2 ms	2 ms	8 ms

(Note 1) VMD_H: $VIN \times 0.55 < \text{Input Voltage} < VIN \times 0.85$
 (Note 2) VMD_L: $VIN \times 0.15 < \text{Input Voltage} < VIN \times 0.55$

Table 12: SEQCNT[1] Operation Mode

SEQCNT[1]	SEQCNT[1]_DATA[2:0]	T3
VIN	"111"	50 ms
VMD_H ^(Note 1)	"011"	40 ms
VMD_L ^(Note 2)	"001"	30 ms
GND	"000"	20 ms

(Note 1) VMD_H: $VIN \times 0.55 < \text{Input Voltage} < VIN \times 0.85$
 (Note 2) VMD_L: $VIN \times 0.15 < \text{Input Voltage} < VIN \times 0.55$

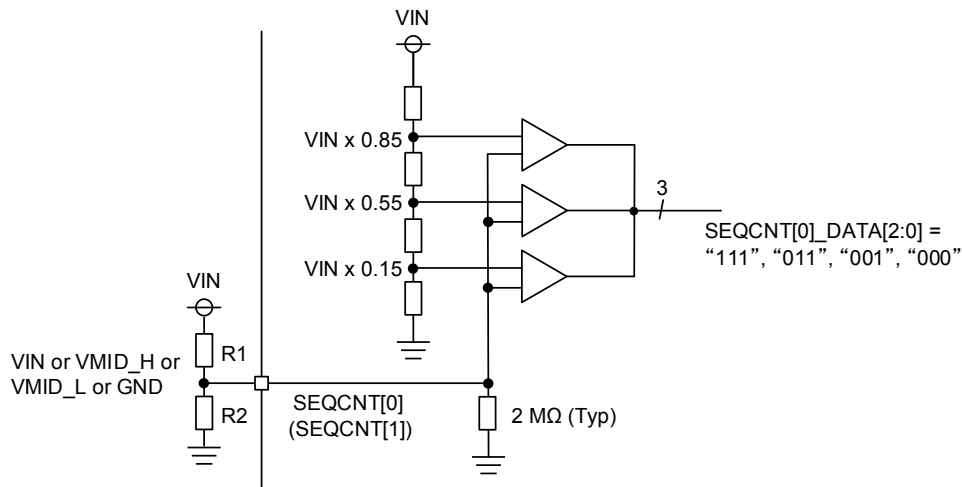

Ex)
 VMID_H (SEQCNT_DATA[2:0] = "011") : R1 = 24 kΩ, R2 = 52 kΩ → $VIN \times 0.68$
 VMID_L (SEQCNT_DATA[2:0] = "001") : R1 = 45 kΩ, R2 = 24 kΩ → $VIN \times 0.35$

Please connect resistors of the total less than 200 kΩ.

Figure 8. SEQCNT Circuit

4.1.8 Initializing Control Circuit

There are 2 initialize conditions. Details of the initializing conditions are shown in following table.

Table 13: Initializing Control Circuit

Reset Name	Initializing Condition	Initializing Target Circuit
VDD reset	UVLO of VFIL	Every Control Circuit
SEQ reset	state transition to STANDBY state	Every Control Circuit except some I2C registers. In more detail, please refer Table 21 I2C I/F Register Map .

4.1 Pin Control Function - continued

4.1.9 VOUT1 Mode Setting

In Mode B, VOUT1 is managed in Sub State. Regarding Main State and Sub State, please refer State Machine. VOUT1 Sub State is activated only in limited Main State. Regarding the "limited Main State", and Sub State, please refer Figure 12 Main State Machine and Figure 13 Sub State Machine.

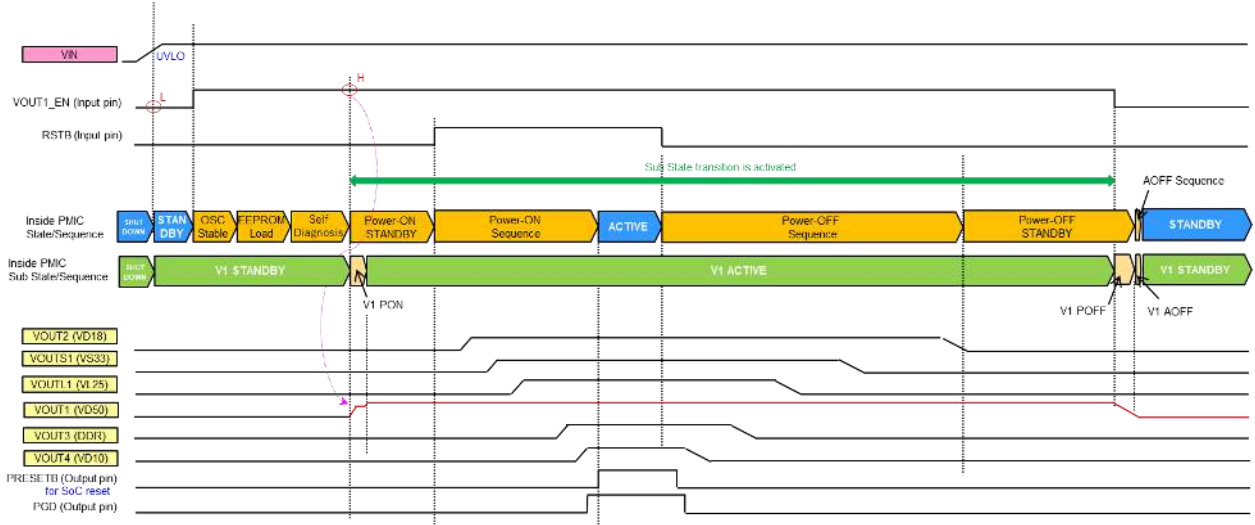

Figure 9. Whole Sequence1 (Mode B)

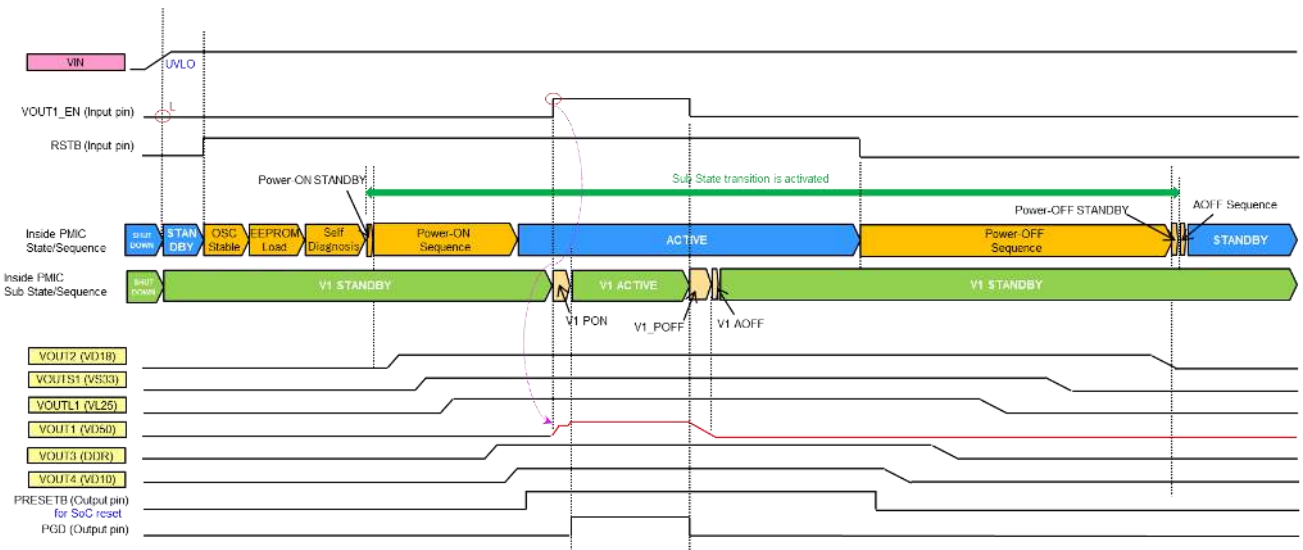

Figure 10. Whole Sequence2 (Mode B)

4.1.9 VOUT1 Mode Setting - continued

When protection error or Hang Up Timer Overflow occurs, all outputs start to Power-OFF at the same time regardless the error is due to VOUT1 or other channels. In this case, VOUT1_EN (pin) = L and RSTB (pin) = L is needed to Re Power-ON.

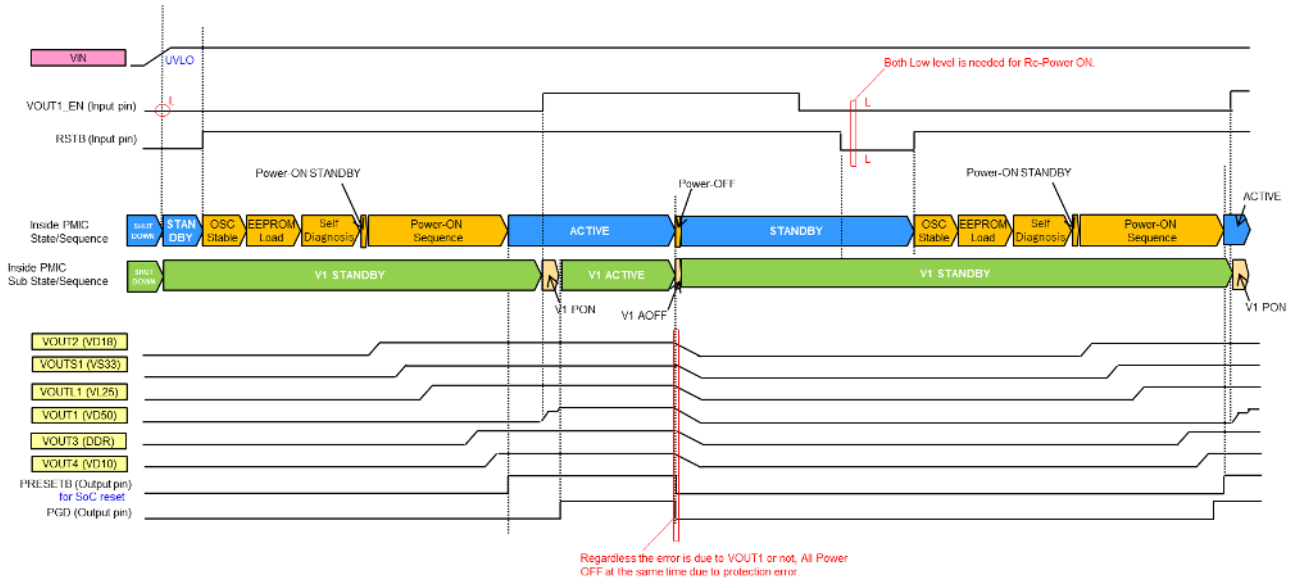

Figure 11. Error Case (Mode B)

4.1 Pin Control Function – continued

4.1.10 State Machine

BD9576MUF-C has two State Machine, Main and Sub. Sub State Machine is for VOUT1 individual control in Mode B.

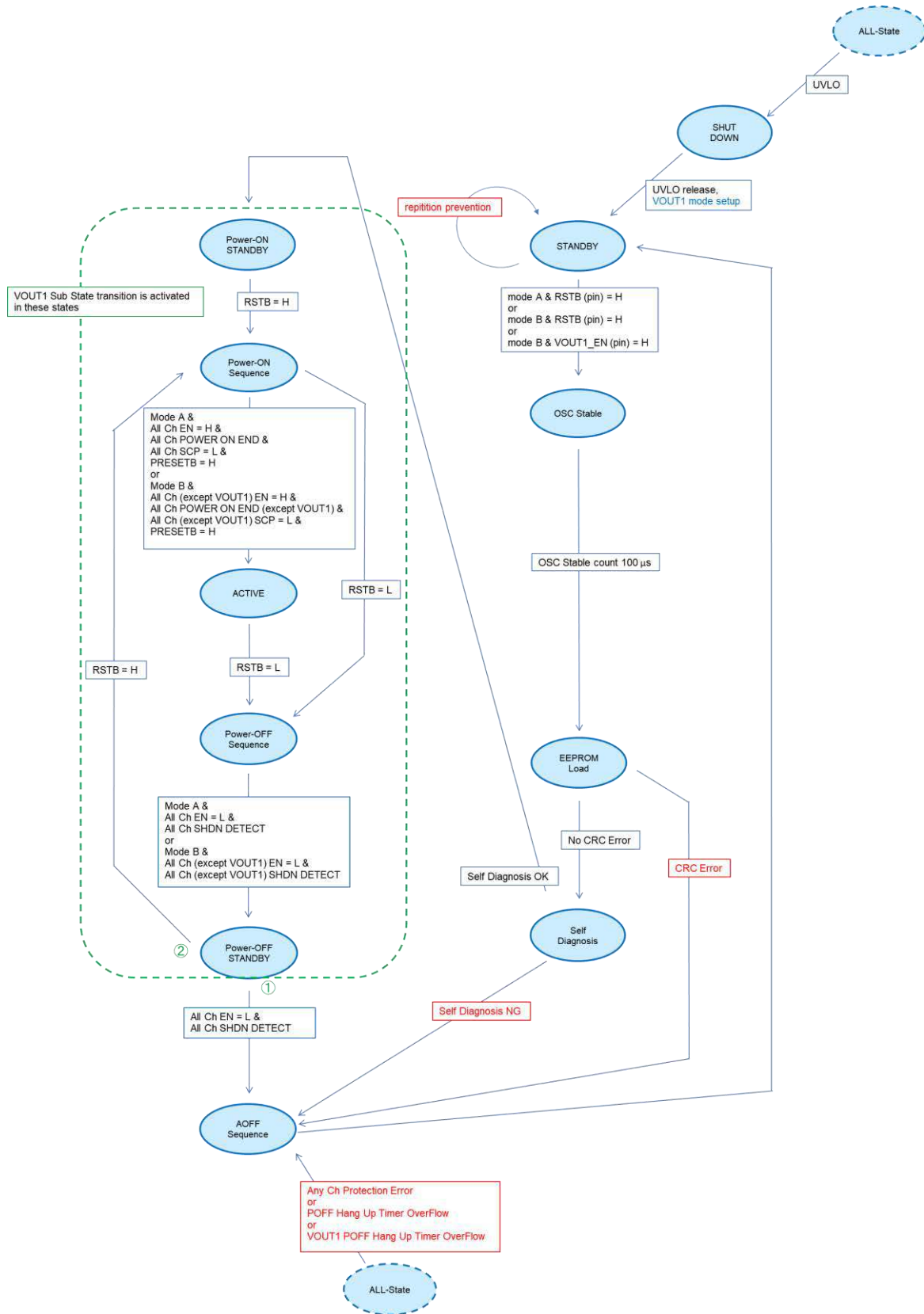

Figure 12. Main State Machine

4.1.10 State Machine - continued

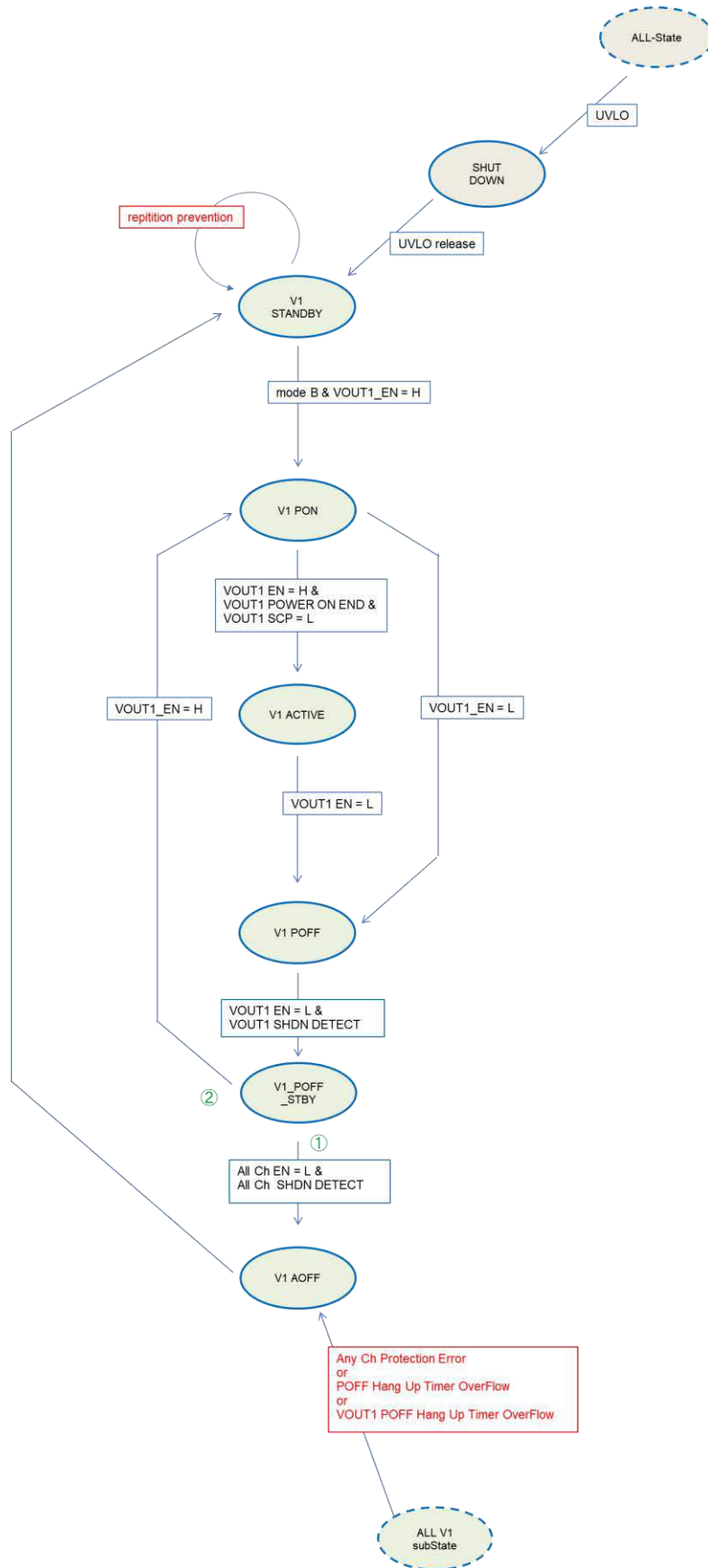

Figure 13. Sub State Machine

4. Function Description - continued

4.2 Whole Sequence Control

4.2.1 Whole Sequence (State Chart)

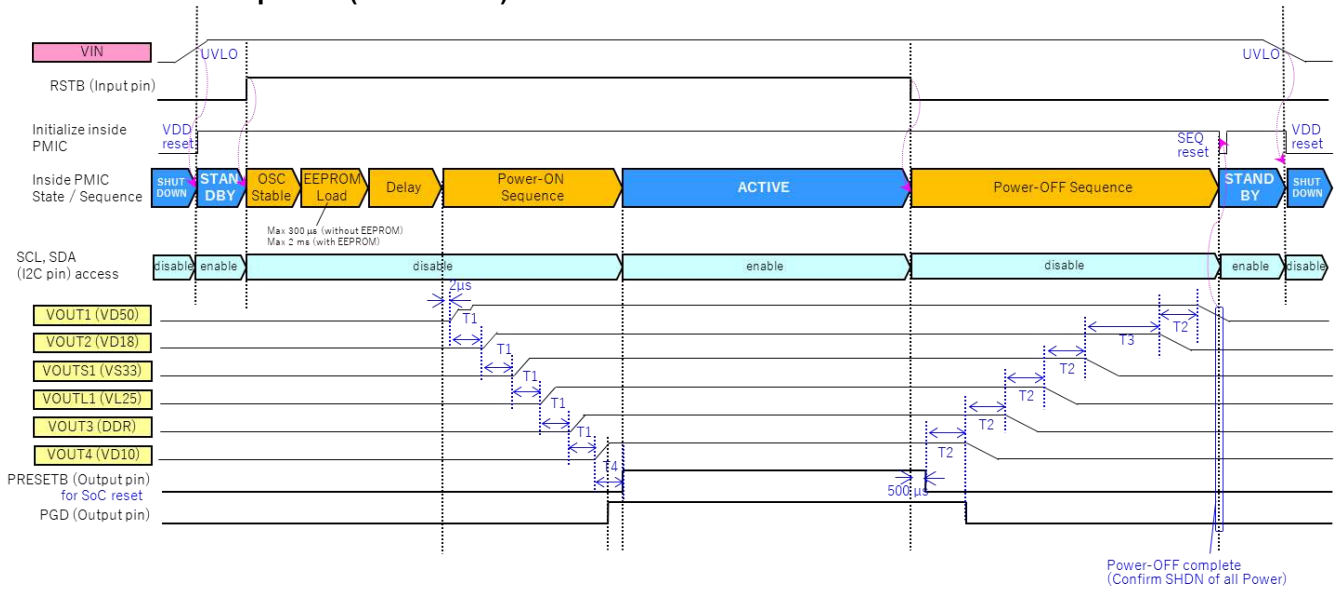

Figure 14. Whole Sequence (State Chart)

4.2.2 General Sequence Description

(SHUTDOWN to STANDBY)

BD9576MUF-C is in SHUTDOWN state during VIN Power off.
 After the input of VIN power, internal state starts transition from SHUTDOWN to STANDBY.
 In STANDBY state,
 Case1: OSC disable (OSC_EN register = "0" setting)
 Case2: OSC enable (OSC_EN register = "1" setting)
 In Case2, I2C write in STANDBY state is possible since OSC clock is supplied.

[Output Power-ON] (STANDBY to ACTIVE)

By the input of RSTB (pin) = H level, internal state starts transition from STANDBY to ACTIVE, and it initiate Output Power-ON. PGD (pin) output is asserted when all output voltage levels are over 75 % (Typ) x V_{OUT}. PRESETB (pin) is asserted with the interval setting. Then, the transition to ACTIVE state is completed.

[Output Power-OFF] (ACTIVE to STANDBY)

By the input of RSTB (pin) = L level, internal state starts transition from ACTIVE to STANDBY and it initiate Output Power-OFF.
 After Power-OFF sequence is completed, BD9576MUF-C is initialized and stops OSC, then completes transition to STANDBY state.

(STANDBY to SHUTDOWN)

UVLO of VFIL becomes effective during VIN power OFF.

4.2.3 I2C Accessible State Condition

I2C accessibility is restricted to only in STANDBY state and ACTIVE state.

Table 14: I2C Accessible Condition

Internal State	I2C read	I2C write
STANDBY	Enable	Disable (with OSC_EN register = "0") / Enable (with OSC_EN register = "1")
EEPROM Load	Disable	Disable
Power-ON STANDBY, ACTIVE, Power-OFF STANDBY	Enable	Enable
Other	Enable	Disable

(Note) Only OSC_EN register can be written without OSC_EN register = "1" setting in STANDBY State.
 Some register I2C read value in STANDBY State are 0x00 (initial value), and they may differ from the value after Power-ON.

4.2 Whole Sequence Control – continued

4.2.4 EEPROM Load Function and Internal OSC Stable Time

By connecting external EEPROM to I2C I/F pin (I2C_SCL, I2C_SDA), functions can be customized by the parameters written in EEPROM.

EEPROM load operates before Power-ON sequence started by RSTB = H level.

If EEPROM is connected, 2 ms (Max) EEPROM load time is needed.

Case1: with EEPROM and correct response from EEPROM, EEPROM parameters are loaded.

Case2: with EEPROM and no response (not Acknowledgement) from EEPROM, initial value is used.

Case3: with EEPROM and can not read check code (CON_CHK_CODE is not 0x8E), initial value is used.

Case4: with EEPROM and CRC error has occurred, internal state returns to STANDBY.

In Case2 and Case3, NO_EEP register is set to "1".

In Case4, EEP_CRC_ERR register is set to "1".

Regarding "CON_CHK_CODE" and detailed EEPROM setting, please refer to BD9576MUF-C EEPROM setting sheet.

4.2.5 Self Diagnosis

When RSTB = H is asserted, Self Diagnosis test is started for UVD, OVD, OCW, SHDN and TW detection circuits.

Case1: If any unexpected behavior is not detected, Power-ON sequence is started.

Case2: If some unexpected behavior is detected, internal state returns to STANDBY.

4.2.6 Prevention of Repetition for Protection Error, EEPROM CRC Error, Self Diagnosis Error

When Protection Error is activated by VR (Voltage Regulator)'s malfunction, every output power is turned off at once and transitions to STANDBY state. In this case, there is a possibility that RSTB = H level is maintained and internal state starts transition from STANDBY to ACTIVE. At that time, every output power is turned off at once again and it may be repeated if the factor of malfunction is not removed.

This kind of repetition is also concerned for EEPROM CRC Error or Self Diagnosis Error case.

To prevent this repetition, state transition from STANDBY does not start until the input of RSTB = L level.

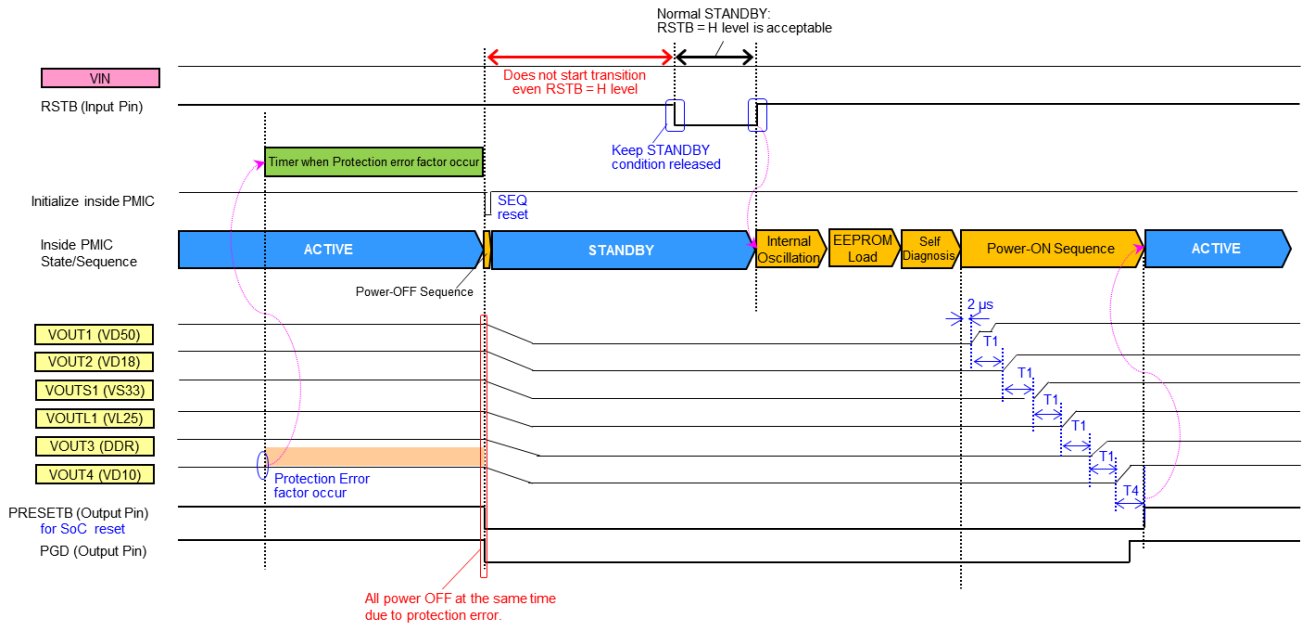

Figure 15. Sequence at Protection Error Occurrence (Timing Chart)

4. Function Description - continued

4.3 VOUT1/VOUTL1 Disable Setting without EEPROM

Without EEPROM setting, VOUT1 output can be set to disable by connecting VIN1 to GND. Same with VOUTL1 output when VIN6 connecting to GND. In this case, disable setting outputs are excluded from the Power-ON / Power-OFF sequence automatically. VOUT1 and VOUTL1 disable setting is judged just before EEPROM Load.

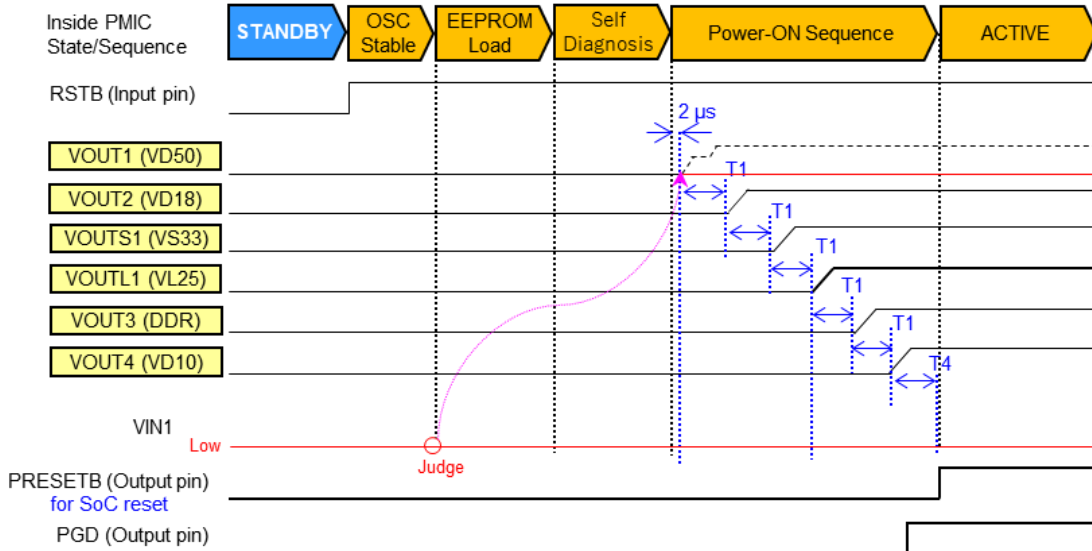

Figure 16. VOUT1 Disable Setting without EEPROM

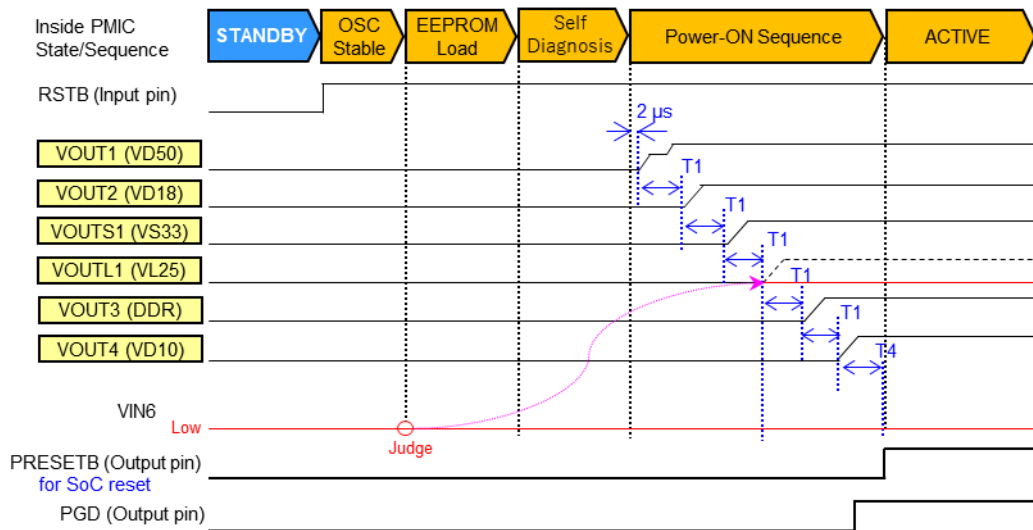

Figure 17. VOUTL1 Disable Setting without EEPROM

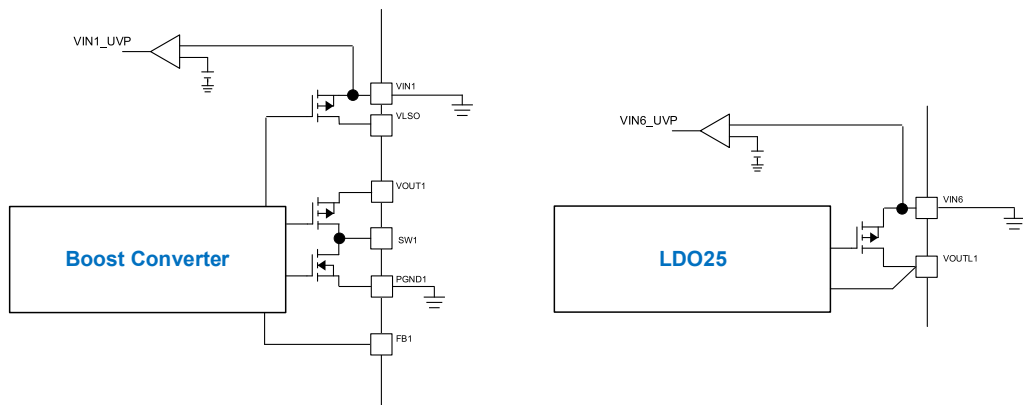

Figure 18. VOUT1, VOUTL1 OFF Circuit

4. Function Description - continued

4.4 VOUTS1 Disable Setting without EEPROM, Internal/External SW Mode Setting

VOUTS1 output mode is selected by GATECNT (pin).

Mode1: Using VOUTS1 internally (GATECNT = L)

Mode2: Using VOUTS1 externally (GATECNT = H)

Without EEPROM setting, VOUTS1 output can be set to disable by connecting VIN7 and GATECNT to GND.

In this case, disable setting outputs are excluded from the Power-ON / Power-OFF sequence automatically.

Internal/External setting is judged at the end of Self Diagnosis, and Disable setting is judged just before EEPROM Load. When Power-On, VOUTS1 is used as internal SW for 4.1 ms (±15 %). VOUTS1 changes to external SW after POWER-ON completion. Therefore, voltage drop may occur in VOUTS1 when big current is loaded from VOUTS1 before POWER-ON completion.

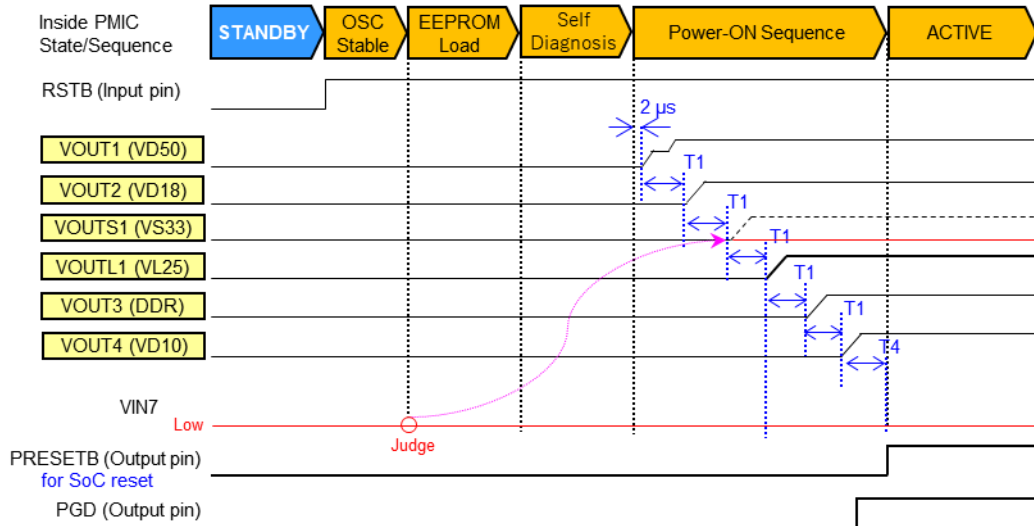

Figure 19. VOUTS1 Disable Setting without EEPROM

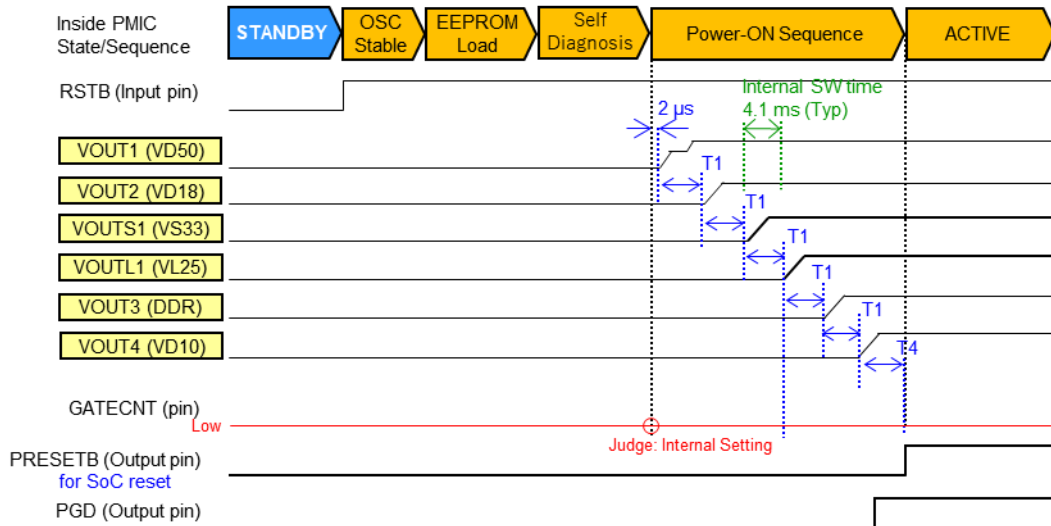

Figure 20. VOUTS1 Internal/External Setting

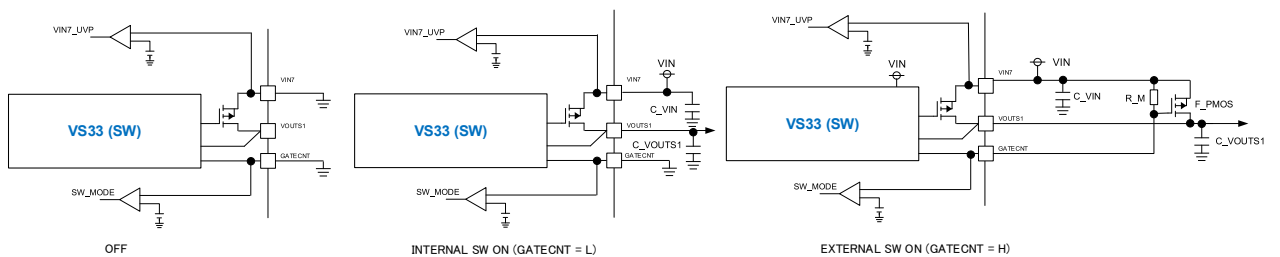

Figure 21. VOUTS1 OFF Circuit and SW Mode Selection

4. Function Description - continued

4.5 I2C I/F

I2C Slave Interface of 1ch is installed in BD9576MUF-C.

I2C Protocol

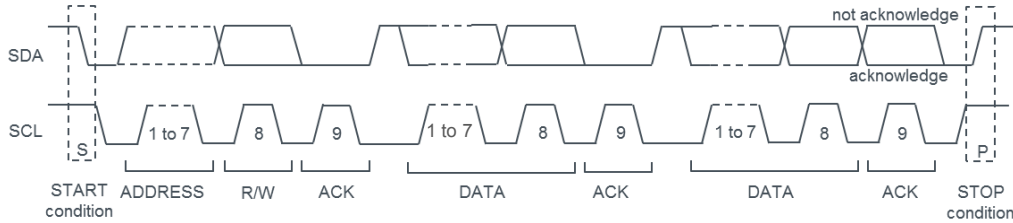

Figure 22. I2C Basic Protocol

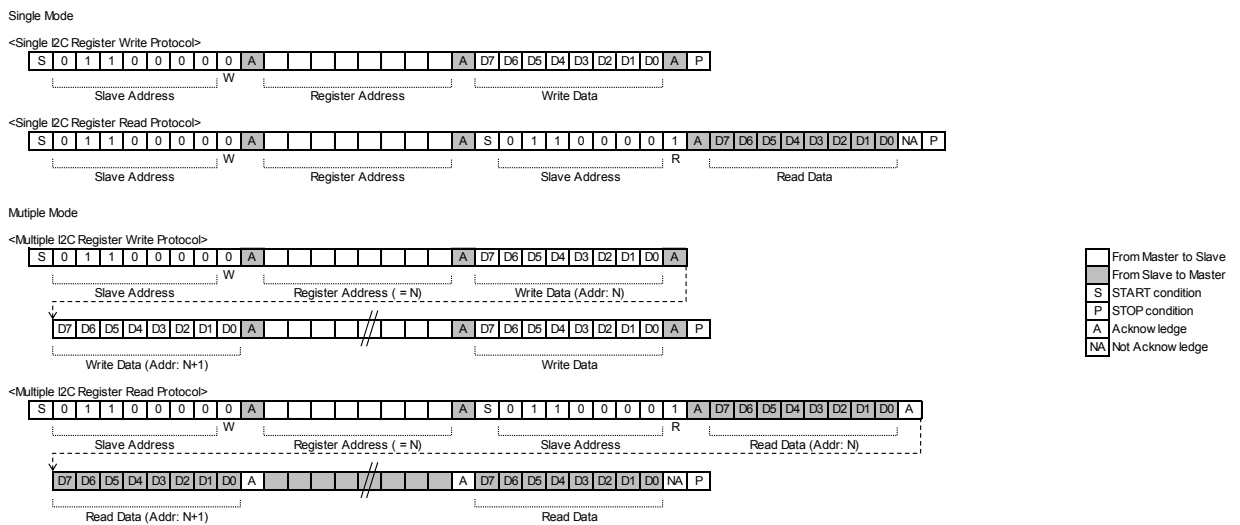

Figure 23. I2C Protocol (Each Access Mode)

Slave Address

Support 7 bit Address mode

Slave Address: 0x30 (When 8 bit description, it is 0x60 in Write mode and 0x61 in Read mode)

Speed Mode

- (1) Fast mode
- (2) Fast mode plus

Frequency

- (1) Fast mode: 400 kHz (Max)
- (2) Fast mode plus: 1 MHz (Max)

I2C accessible State condition

- (1) I2C read condition: except EEPROM Load state
- (2) I2C write condition: In STANDBY state (with OSC_EN register = "1" setting) or ACTIVE state

(Note) For I2C write condition in STANDBY state, 110 μs (Max) wait time after OSC_EN register = "1" is needed.

ACK/NACK Criterion

- NACK is output when the Slave Address is not set to 0x30.
- NACK is output without the I2C accessible State condition.
- ACK is output even with read/write access to register address that is not being used.
- ACK is output even with write access to RO attribute register.

Bus Clear

If the data line (SDA) is stuck LOW, please send 18 clock pulses. By this procedure, SDA bus is released. If not, then use the Hardware reset or cycle power to clear the bus.

4.5 I2C I/F – continued

FuSa Mode (Error Detection / Rectification Mode)

FuSa (Functional Safety) mode is a function to detect/rectify transfer error. The 2nd byte of writing data at I2C transfer is given as a FuSa byte to confirm.

Normal I2C mode or FuSa mode (type1, type2) is selectable by I2C FuSa mode register.

The transfer protocol for this uses the same conventional I2C protocol.

Continuous data write with register address increment is supported.

(Odd-bytes of writing data are the actual data and even-bytes are FuSa byte for confirmation. Address increments every 2 bytes.)

(If FuSa byte returns with error, then the corresponding byte is not written. If the FuSa byte returns without error, then the corresponding byte is written).

FuSa Mode is applied not only write data but also read data by I2C FuSa mode register setting.

Mode switching is valid from the next transferred byte after settings are changed.

Single Mode

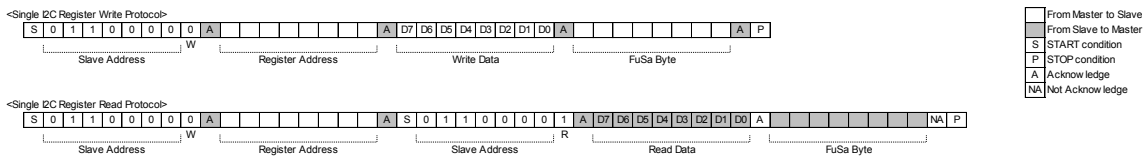

Multiple Mode

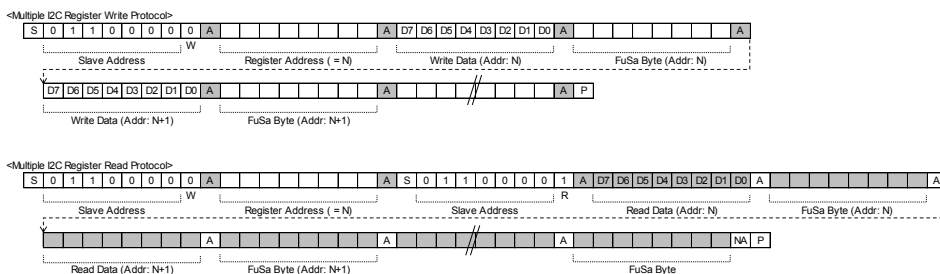
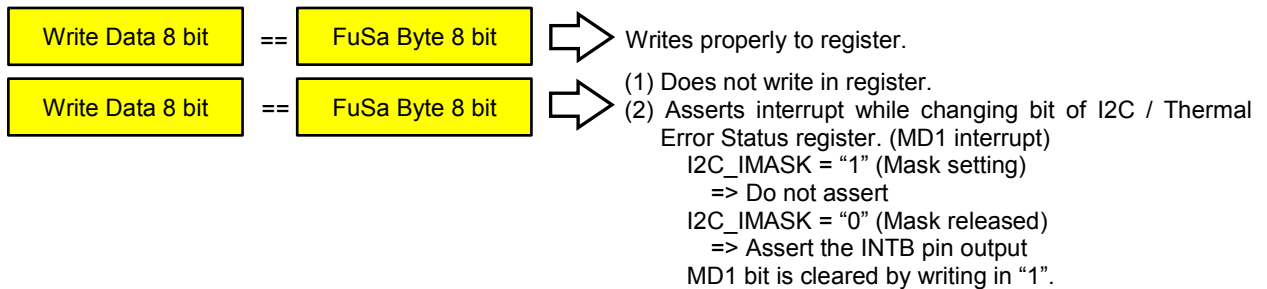
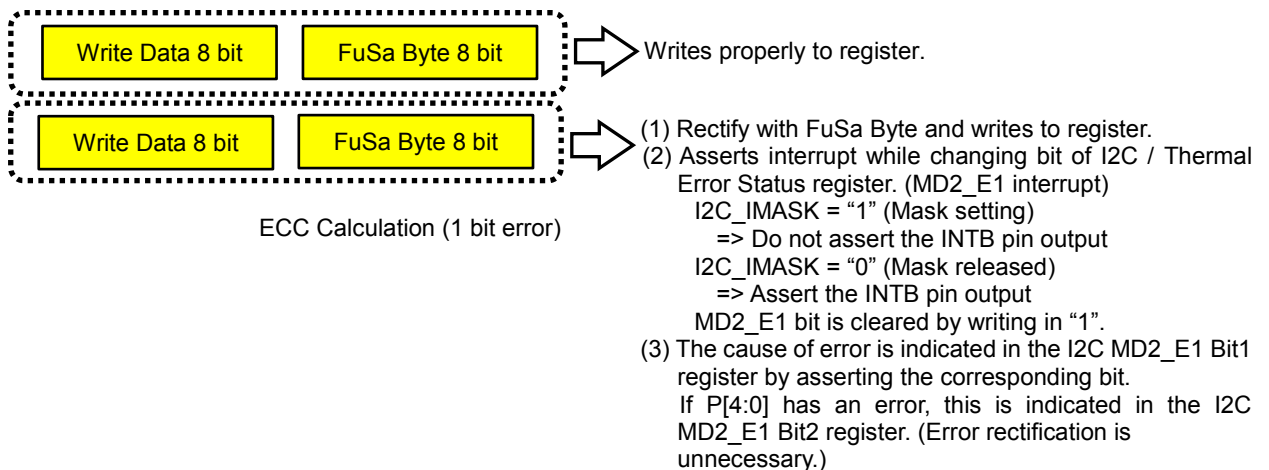

Figure 24. I2C Protocol (FuSa Mode)

[FuSa Mode Type1: Compare Write Data and FuSa Byte]



[FuSa Mode Type2: Error Correction by FuSa Byte (Error 1 bit)]



4.5 I2C I/F – continued

[FuSa Mode Type2: Error Correction by FuSa Byte (Error more than 2 bit)]

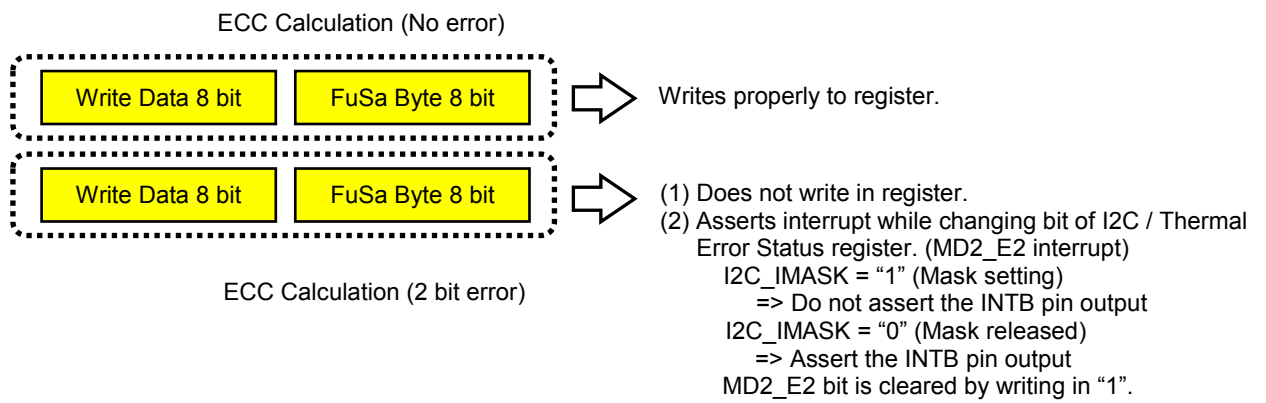

4.5 I2C I/F – continued

ECC Calculation Specification

Arrange and add P[4:0] on LSB as FuSa byte[7:0] for FuSa mode type2.

I2C Data Stream

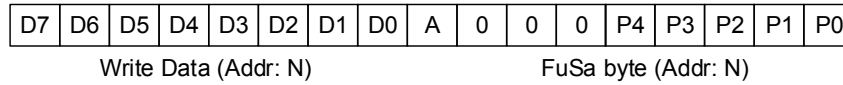

Figure 25. I2C Data Format (FuSa Mode type2 = ECC at Calculation)

Transmitter [Encode]

Calculation method of P[4:0] added to DI[7:0] data (“^” means XOR calculation)

$$\begin{aligned}
 P[0] &= DI[0] \wedge DI[1] \wedge DI[3] \wedge DI[4] \wedge DI[6] \\
 P[1] &= DI[0] \wedge DI[2] \wedge DI[3] \wedge DI[5] \wedge DI[6] \\
 P[2] &= DI[1] \wedge DI[2] \wedge DI[3] \wedge DI[7] \\
 P[3] &= DI[4] \wedge DI[5] \wedge DI[6] \wedge DI[7] \\
 P[4] &= DI[0] \wedge DI[1] \wedge DI[2] \wedge DI[3] \wedge DI[4] \wedge DI[5] \wedge DI[6] \wedge DI[7] \wedge P[0] \wedge P[1] \wedge P[2] \wedge P[3]
 \end{aligned}$$

Receiver [Decode]

Error detecting and rectifying method by ECC Factor, receiving DI[7:0] and P[4:0].

ECC Factor Calculation Method

=> Error Detection Judgment/Error

$$\begin{aligned}
 ECC[0] &= P[0] \wedge DI[0] \wedge DI[1] \wedge DI[3] \wedge DI[4] \wedge DI[6] \\
 ECC[1] &= P[1] \wedge DI[0] \wedge DI[2] \wedge DI[3] \wedge DI[5] \wedge DI[6] \\
 ECC[2] &= P[2] \wedge DI[1] \wedge DI[2] \wedge DI[3] \wedge DI[7] \\
 ECC[3] &= P[3] \wedge DI[4] \wedge DI[5] \wedge DI[6] \wedge DI[7] \\
 ECC[4] &= DI[0] \wedge DI[1] \wedge DI[2] \wedge DI[3] \wedge DI[4] \wedge DI[5] \wedge DI[6] \wedge DI[7] \wedge P[0] \wedge P[1] \wedge P[2] \wedge P[3] \wedge P[4]
 \end{aligned}$$

(1) Error Detection Judgment
Error Detection Judgment based on ECC Factor

Parity Check ECC[4]	Error Codes ECC[3:0]	Bit in Error	PMIC behavior		Parity Check ECC[4]	Error Codes ECC[3:0]	Bit in Error	PMIC behavior	
			Error Processing	Flagged Register				Error Processing	Flagged Register
0	0000	No error	-	-	1	0000	P4	-	MD2_E1_INT
0	0001	Multi-bit	Error Detection	MD2_E2_INT	1	0001	P0	-	MD2_E1_INT
0	0010	Multi-bit	Error Detection	MD2_E2_INT	1	0010	P1	-	MD2_E1_INT
0	0011	Multi-bit	Error Detection	MD2_E2_INT	1	0011	D0	Error Correction	MD2_E1_INT
0	0100	Multi-bit	Error Detection	MD2_E2_INT	1	0100	P2	-	MD2_E1_INT
0	0101	Multi-bit	Error Detection	MD2_E2_INT	1	0101	D1	Error Correction	MD2_E1_INT
0	0110	Multi-bit	Error Detection	MD2_E2_INT	1	0110	D2	Error Correction	MD2_E1_INT
0	0111	Multi-bit	Error Detection	MD2_E2_INT	1	0111	D3	Error Correction	MD2_E1_INT
0	1000	Multi-bit	Error Detection	MD2_E2_INT	1	1000	P3	-	MD2_E1_INT
0	1001	Multi-bit	Error Detection	MD2_E2_INT	1	1001	D4	Error Correction	MD2_E1_INT
0	1010	Multi-bit	Error Detection	MD2_E2_INT	1	1010	D5	Error Correction	MD2_E1_INT
0	1011	Multi-bit	Error Detection	MD2_E2_INT	1	1011	D6	Error Correction	MD2_E1_INT
0	1100	Multi-bit	Error Detection	MD2_E2_INT	1	1100	D7	Error Correction	MD2_E1_INT
0	1101	Multi-bit	Error Detection	MD2_E2_INT	1	1101	Multi-bit	Error Detection	MD2_E2_INT
0	1110	Multi-bit	Error Detection	MD2_E2_INT	1	1110	Multi-bit	Error Detection	MD2_E2_INT
0	1111	Multi-bit	Error Detection	MD2_E2_INT	1	1111	Multi-bit	Error Detection	MD2_E2_INT

for displaying error bit position I2C MD2_E1 Bit 1 register I2C MD2_E1 Bit 2 register

Figure 26. Error Detection Judgement by ECC Calculation

(2) Error Rectification

Error Correction is operated by following calculation for Single bit Error.

$$\begin{aligned}
 DO[0] &= DI[0] \wedge (ECC[0] \wedge ECC[1] \wedge \sim ECC[2] \wedge \sim ECC[3] \wedge ECC[4]) \\
 DO[1] &= DI[1] \wedge (ECC[0] \wedge \sim ECC[1] \wedge ECC[2] \wedge \sim ECC[3] \wedge ECC[4]) \\
 DO[2] &= DI[2] \wedge (\sim ECC[0] \wedge ECC[1] \wedge ECC[2] \wedge \sim ECC[3] \wedge ECC[4]) \\
 DO[3] &= DI[3] \wedge (ECC[0] \wedge ECC[1] \wedge ECC[2] \wedge \sim ECC[3] \wedge ECC[4]) \\
 DO[4] &= DI[4] \wedge (ECC[0] \wedge \sim ECC[1] \wedge \sim ECC[2] \wedge ECC[3] \wedge ECC[4]) \\
 DO[5] &= DI[5] \wedge (\sim ECC[0] \wedge ECC[1] \wedge \sim ECC[2] \wedge ECC[3] \wedge ECC[4]) \\
 DO[6] &= DI[6] \wedge (ECC[0] \wedge ECC[1] \wedge \sim ECC[2] \wedge ECC[3] \wedge ECC[4]) \\
 DO[7] &= DI[7] \wedge (\sim ECC[0] \wedge \sim ECC[1] \wedge ECC[2] \wedge ECC[3] \wedge ECC[4])
 \end{aligned}$$

Figure 27. Error Correction Calculation

4. Function Description - continued

4.6 Interrupt Function

4.6.1 Interrupt Function Description

Interruptions are notified from the INTB pin when interruption requests are enabled by any interruption factors. The meaning of the words relevant to interruption are defined as followed.

“Interruption Factor”: Factor of any condition where an interruption is made.

“Interruption Mask”: Controls which interruption factors cause an interruption to occur.

(Masked: No interruption / No Mask: interruption occurs).

“Interruption Request”: Interruption request only becomes active when the interruption factor is active and the interruption is not masked.

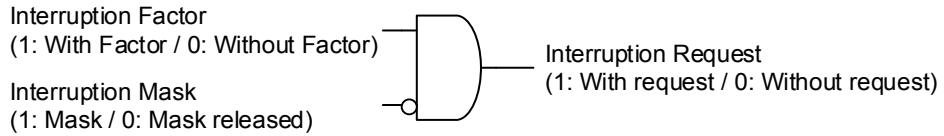

Figure 28. Interruption Factor/Mask/Request

Each factor can be masked, read or cleared by I2C. Also, INTB utilizes active-low pin operation.

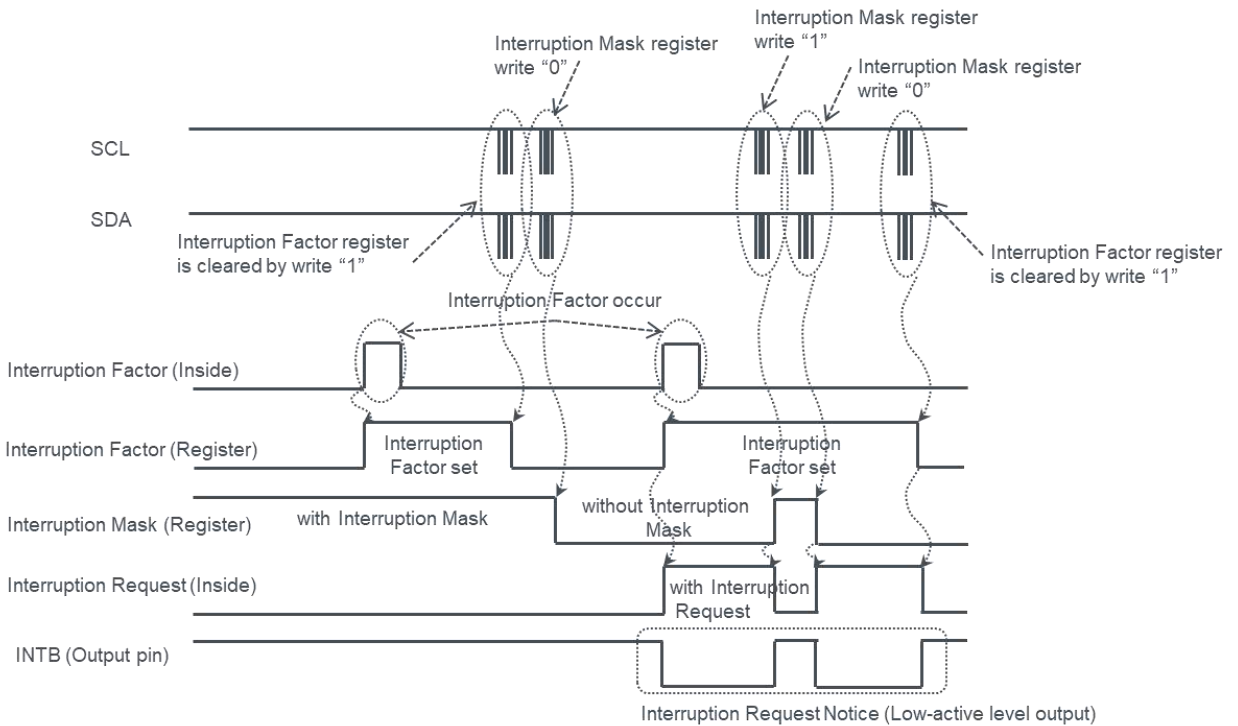

Figure 29. Interrupt Function Description

4.6 Interrupt Function – continued

4.6.2 Interruption Factor

Interruption request notice function is implemented in 2 levels for the factor.

- (1) Primary level interruption register of final stage
- (2) Interruption register in secondary level of each function block stage

Following figure shows the logical flowchart of Interruption Factor/Mask/Request implemented in BD9576MUF-C.

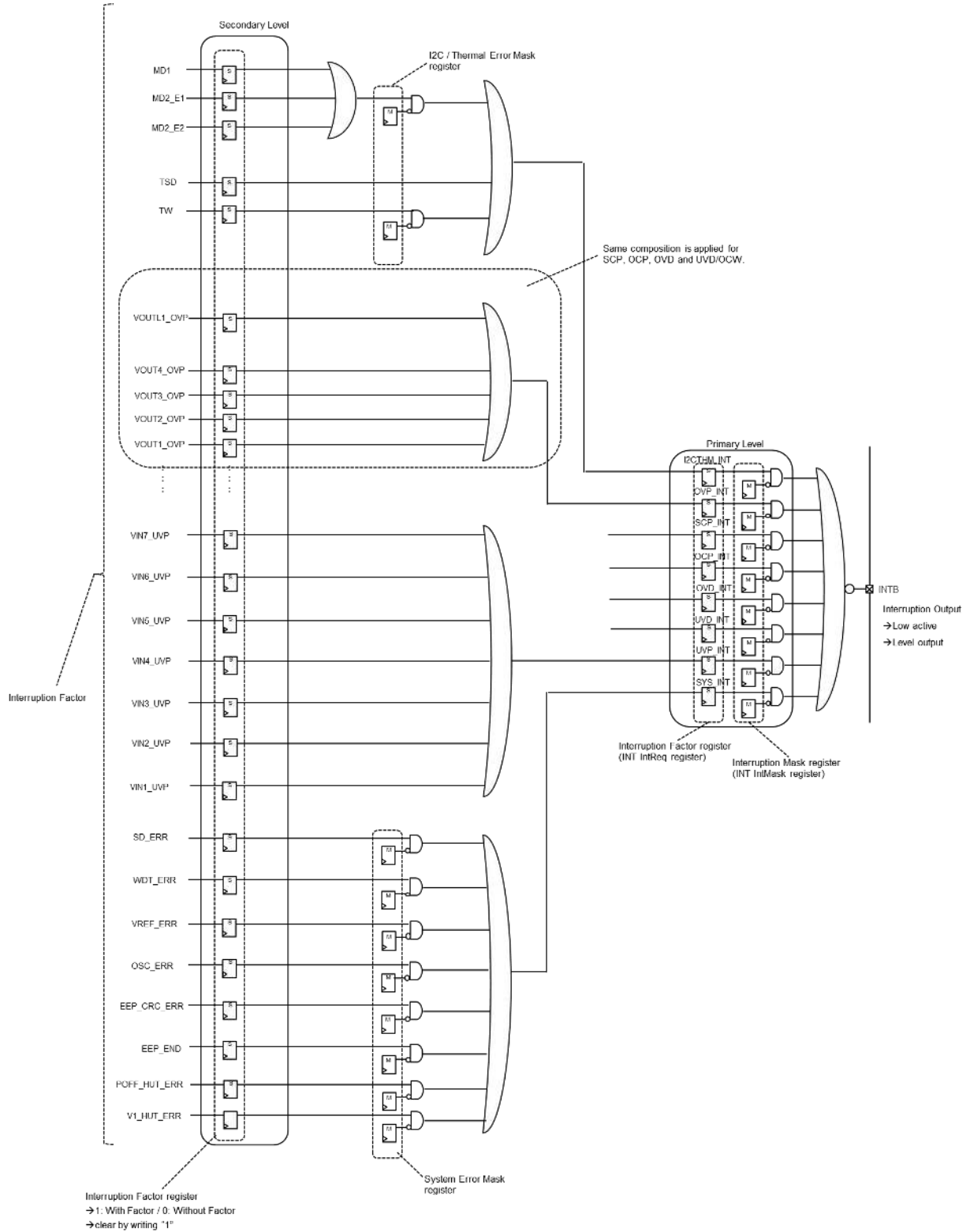

Figure 30. System Diagram of Interruption Function

4.6.2 Interruption Factor - continued

Following Shows All Interruption Factors.

(A) Interruption in Primary level

Interruption Factor register: INT IntReq register

Interruption Mask register: INT IntMask register

Table 15: Interruption at Primary Level

Interruption Factor (INT IntReq Register)	Interruption Mask (INT IntMask Register)	Detail of Interruption Factor	Active Condition of Interruption Factor
I2CTHM_INT	I2CTHM_IMASK	I2C Transfer Error, Thermal Error (TSD, TW)	Error judged at writing register, Thermal Error detection
OVP_INT	OVP_IMASK	OVP Error Status	OVP detection
SCP_INT	SCP_IMASK	SCP Error Status	SCP detection
OCP_INT	OCP_IMASK	OCP Error Status	OCP detection
OVD_INT	OVD_IMASK	OVD Error Status	OVD detection
UVD_INT	UVD_IMASK	UVD Error Status	UVD detection
UVP_INT	UVP_IMASK	UVP Error Status	UVP detection
SYS_INT	SYS_IMASK	System Error Status	System Error detection

(B) Interruption in Secondary Level

Regarding factors in Secondary Level, please refer the next page.

4.6.2 Interruption Factor - continued

Table 16: Interruption at Secondary Level 2

Interruption Request	Interruption Mask	Detail of Interruption Factor	
MD1	I2C_IMASK	FuSa Mode Type1 error	
MD2_E1		FuSa Mode Type2 error 1 bit	
MD2_E2		FuSa Mode Type2 error more than 2 bit	
TSD	-	Thermal Shutdown	
TW	TW_IMASK	Thermal Warning	
VOUT1_OVP	-	VD50 power Output over voltage protection	
VOUT2_OVP		VD18 power Output over voltage protection	
VOUT3_OVP		DDR power Output over voltage protection	
VOUT4_OVP		VD10 power Output over voltage protection	
VOU1L1_OVP		VL25 power Output over voltage protection	
VOUT1_OCP	-	VD50 power Output over current protection	
VOUT2_OCP		VD18 power Output over current protection	
VOUT3_OCP		DDR power Output over current protection	
VOUT4A_OCP		VD10A power Output over current protection	
VOUT4B_OCP		VD10B power Output over current protection	
VOU1S1_OCP	-	VS33 power Output over current protection	
LDSW_OCP		LDSW power Output over current protection	
VOUT1_SCP		VD50 power Output short circuit protection	
VOUT2_SCP		VD18 power Output short circuit protection	
VOUT3_SCP		DDR power Output short circuit protection	
VOUT4_SCP	-	VD10 power Output short circuit protection	
VOU1L1_SCP		VL25 power Output short circuit protection	
VOUT1_OVD		VD50 power Output over voltage detection	
VOUT2_OVD		VD18 power Output over voltage detection	
VOUT3_OVD		DDR power Output over voltage detection	
VOUT4_OVD	-	VD10 power Output over voltage detection	
VOU1L1_OVD		VL25 power Output over voltage detection	
VOUT1_UVD		VD50 power Output under voltage detection	
VOUT2_UVD		VD18 power Output under voltage detection	
VOUT3_UVD		DDR power Output under voltage detection	
VOUT4_UVD	-	VD10 power Output under voltage detection	
VOU1L1_UVD		VL25 power Output under voltage detection	
VOU1S1_OCW		VS33 power Output over current warning	
VIN1_UVP		-	VD50 power Input under voltage protection
VIN2_UVP			VD18 power Input under voltage protection
VIN3_UVP	DDR power Input under voltage protection		
VIN4_UVP	VD10A power Input under voltage protection		
VIN5_UVP	VD10B power Input under voltage protection		
VIN6_UVP	VL25 power Input under voltage protection		
VIN7_UVP	VS33 power Input under voltage protection		
SD_ERR	SD_E_IMASK	Error Detection during Self Diagnosis	
WDT_ERR	WDT_E_IMASK	WDI Input Clock Frequency Error	
VREF_ERR	VREF_E_IMASK	Reference Voltage Mutual Monitor Error	
OSC_ERR	OSC_E_IMASK	Oscillator Frequency Mutual Monitor Error	
EEP_CRC_ERR	EEPCRC_E_IMASK	CRC Error during EEPROM Load	
EEP_END	EEP_END_IMASK	EEPROM Load End	
POFF_HUT_ERR	POFFHUT_E_IMASK	Hang-Up Timer counts over 400 ms	
V1_HUT_ERR	V1_HUT_E_IMASK	Hang-Up Timer for VOUT1 (only for Mode B), 100 ms	

4. Function Description - continued

4.7 Power Abnormality Monitoring Function (Protection Error Detection)

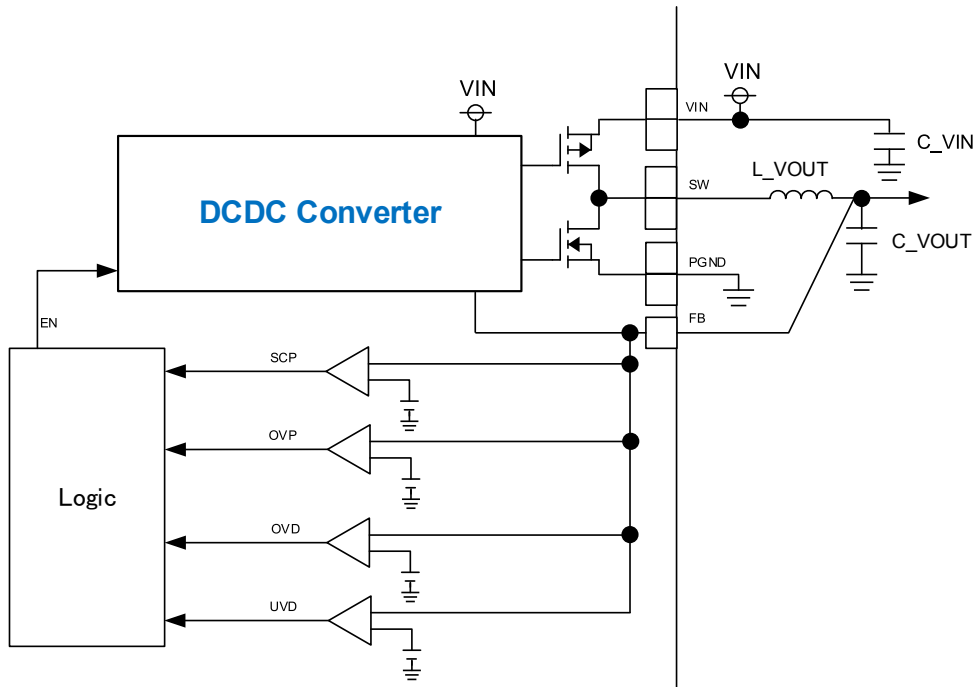

Figure 31. Power Abnormality Monitoring Circuit

Power Abnormality Monitoring Function for SCP and OCP work as follows:
 LDSW_OCP function is excluded.

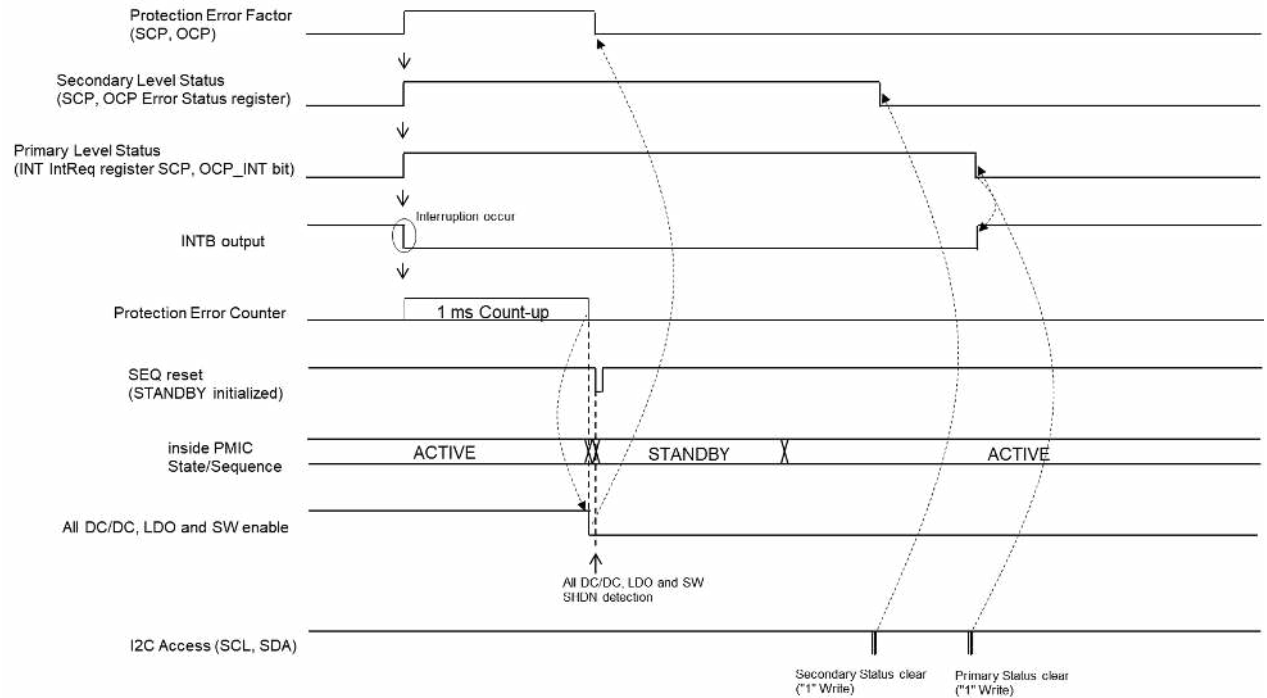

Figure 32. Timing Chart when Protection Error Factor Occur 1

4.7 Power Abnormality Monitoring Function (Protection Error Detection) – continued

Power Abnormality Monitoring Function for OVP and TSD work as follows:

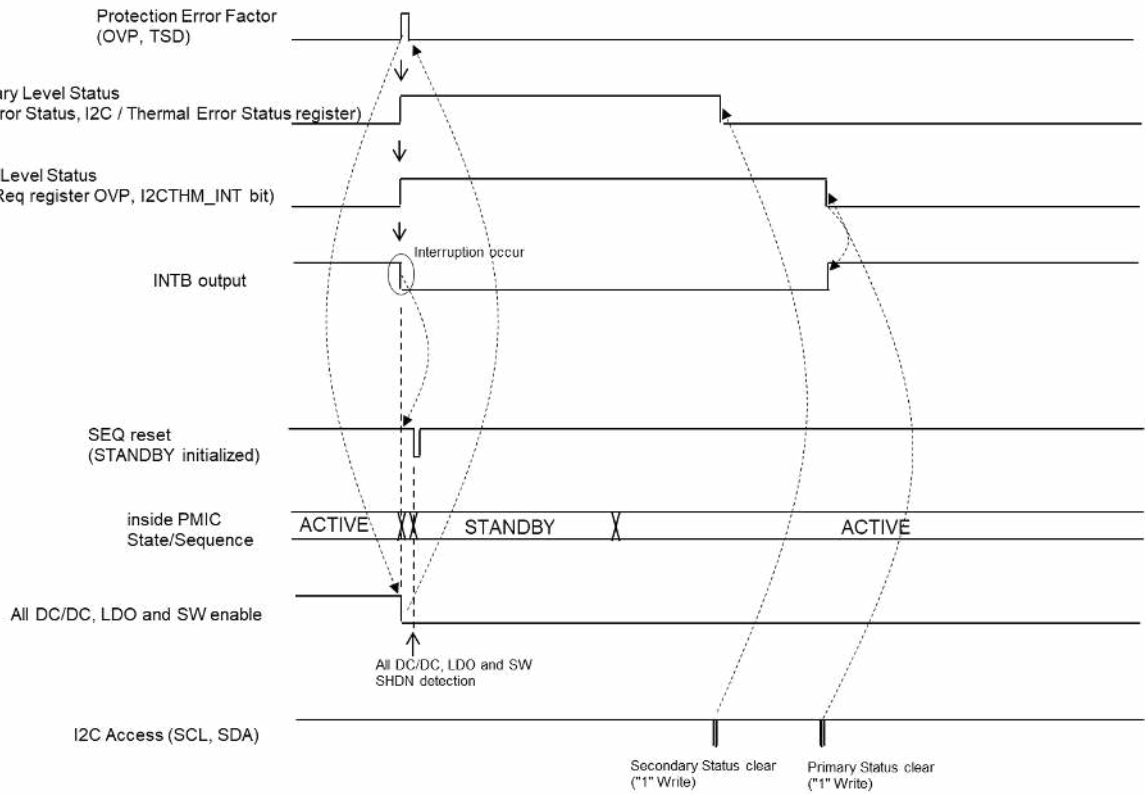

Figure 33. Timing Chart when Protection Error Factor Occur 2

Power Abnormality Monitoring Function for OVD and UVD work as follows:

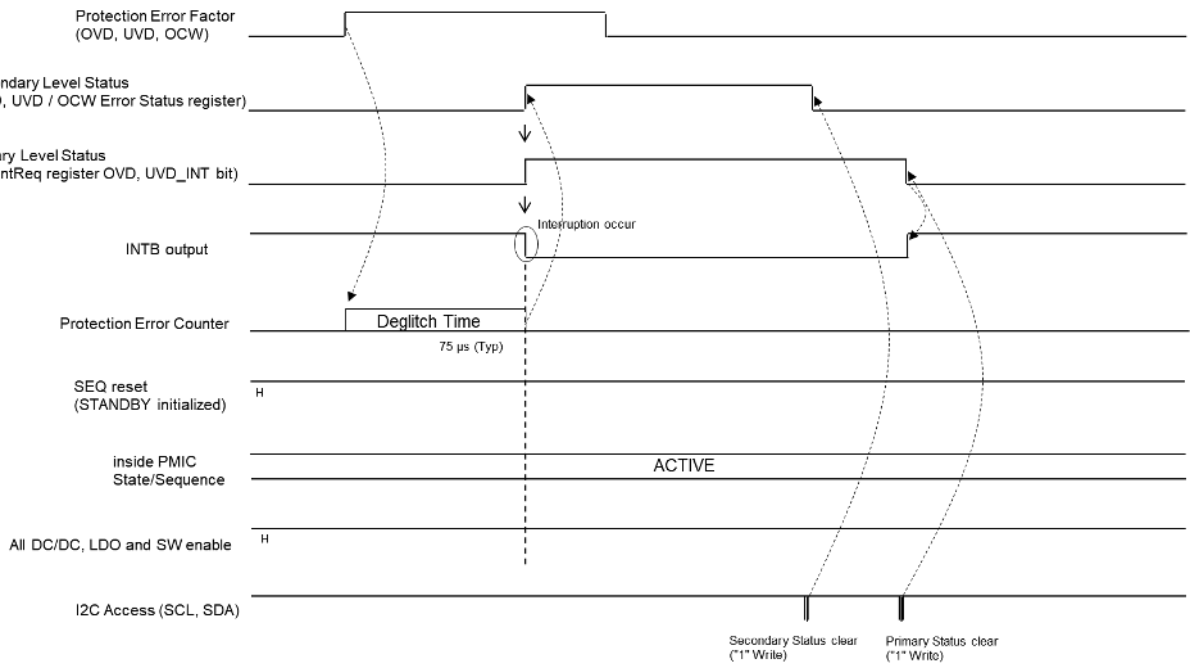

Figure 34. Timing Chart when Protection Detection Factor Occur

OVD and UVD monitors whether the output voltage is proper or not.

4. Function Description - continued

4.8 SYNC Function

The SYNC pin is used to synchronize the DC/DC switching frequency with external pulse clock signal. SYNC input frequency range is from 1.8 MHz to 2.2 MHz, and SYNC input pulse duty range is from 45 % to 55 %. Entering abnormal clock through the SYNC pin (e.g. out of range signal) may cause malfunction.

The external pulse clock signal is reflected in ACTIVE mode. This pin can be remained open if synchronization is not needed. The SYNC pin needs 10 k Ω external pull down resistor when synchronization signal is supplied from R-car SoC.

4. Function Description - continued

4.9 WDT Function

Watch Dog Timer (WDT) monitors the WDI pin input by detecting the rising edge of WDI input pulse. This function is enabled by WDEN (pin) = H in ACTIVE state. If WDT Error is detected, the WDO pin output is negated.

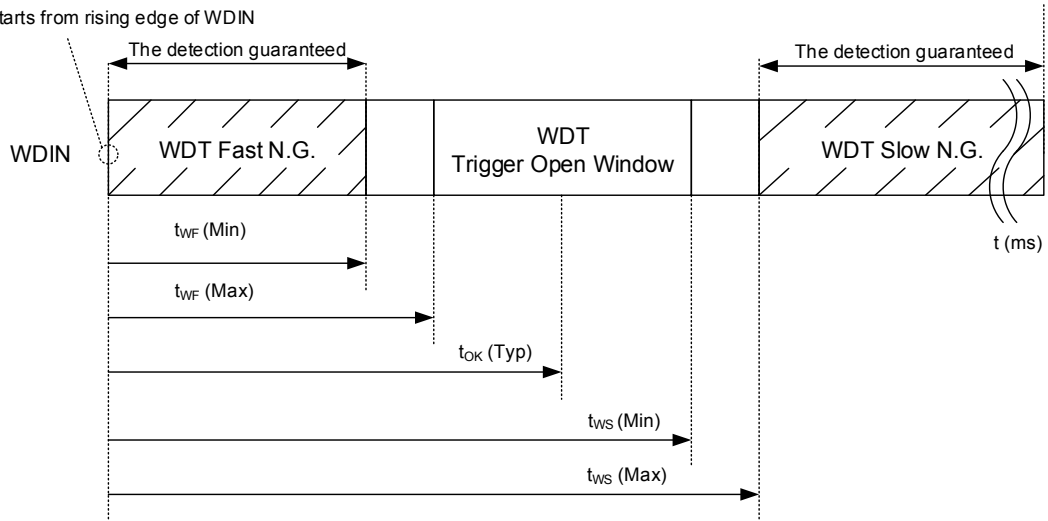

Figure 35. WDT Function

WDT FAST N.G. Detection

1. WDI input signal is ignored when WDEN = L or internal state is not ACTIVE. WDT is activated when WDEN = H.
2. For the initial duration just after WDEN goes to high, only SLOW N.G. time detection works and FAST N.G. does not work. If rise edge of WDI comes within SLOW N.G. time, then
 - (1) both FAST N.G. and SLOW N.G. time detections start to work. (TYPE register (0x16[5]) = H)
 - (2) only SLOW N.G. time detection starts to work. (TYPE register (0x16[5]) = L)
3. These time detection monitors the time until next rising edge and when it detects WDI edge within FAST N.G. time (t_{WF}), WDO becomes LOW. WDO goes back to High after 100 ms (Typ) delay.
4. When WDO becomes High, WDT is activated again and operation resumes. Only SLOW N.G. time detection works until the next first rising edge, and both SLOW and FAST N.G. starts at the first rising edge like state 1.

When WDEN is Low, WDO becomes H and WDT is disabled. During this period, WDI input signal is ignored and WDO output is not affected.

Regarding WDI input signal, over 200 μs H level is required to be detected as "H" level.

FAST/SLOW N.G. Detection Area is determined by FAST_NG[2:0] and NG_RATIO[1:0] register setting. WDI input clock duration is set by FAST_NG[2:0] register value.

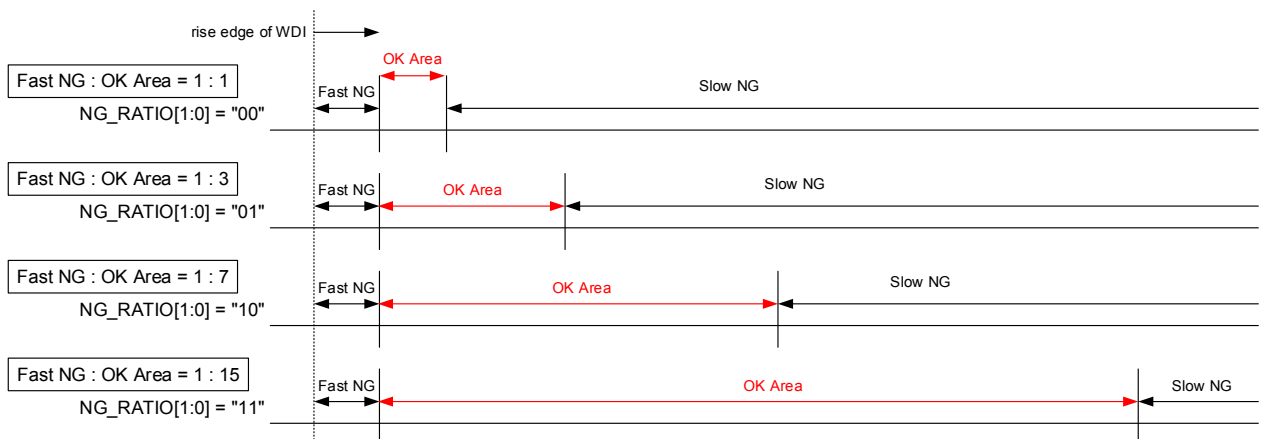

Figure 36. WDT NG RATIO

4.9 WDT Function – continued

Table 17: WDT setting (NG_RATIO[1:0] = "00")

FAST_NG[2:0]	Fast NG Detection (ms)		t _{OK} (ms) (Typ)	Slow NG Detection (ms)	
	t _{WF} (Min)	t _{WF} (Max)		t _{WS} (Min)	t _{WS} (Max)
"000"	1.7	2.3	3.0	3.6	4.6
"001"	3.4	4.6	6.0	7.4	9.2
"010"	6.8	9.2	12.0	14.5	18.5
"011"	13.5	18.5	24.0	29.5	36.5
"100"	27.5	36.5	48.0	59.5	73.0
"101"	55.0	73.0	96.0	119.0	146.0
"110"	110.0	146.0	192.0	238.0	292.0
"111"	220.0	292.0	384.0	476.0	583.0

Table 18: WDT setting (NG_RATIO[1:0] = "01")

FAST_NG[2:0]	Fast NG Detection (ms)		t _{OK} (ms) (Typ)	Slow NG Detection (ms)	
	t _{WF} (Min)	t _{WF} (Max)		t _{WS} (Min)	t _{WS} (Max)
"000"	1.7	2.3	4.8	7.2	9.2
"001"	3.4	4.6	9.7	14.8	18.4
"010"	6.8	9.2	19.0	29.0	37.0
"011"	13.5	18.5	39.0	59.0	73.0
"100"	27.5	36.5	78.0	119.0	146.0
"101"	55.0	73.0	156.0	238.0	292.0
"110"	110.0	146.0	311.0	476.0	584.0
"111"	220.0	292.0	622.0	952.0	1166.0

Table 19: WDT setting (NG_RATIO[1:0] = "10")

FAST_NG[2:0]	Fast NG Detection (ms)		t _{OK} (ms) (Typ)	Slow NG Detection (ms)	
	t _{WF} (Min)	t _{WF} (Max)		t _{WS} (Min)	t _{WS} (Max)
"000"	1.7	2.3	8.4	14.4	18.4
"001"	3.4	4.6	17.0	29.6	36.8
"010"	6.8	9.2	33.5	58.0	74.0
"011"	13.5	18.5	68.0	118.0	146.0
"100"	27.5	36.5	137.0	238.0	292.0
"101"	55.0	73.0	275.0	476.0	584.0
"110"	110.0	146.0	550.0	952.0	1168.0
"111"	220.0	292.0	1100.0	1904.0	2332.0

Table 20: WDT setting (NG_RATIO[1:0] = "11")

FAST_NG[2:0]	Fast NG Detection (ms)		t _{OK} (ms) (Typ)	Slow NG Detection (ms)	
	t _{WF} (Min)	t _{WF} (Max)		t _{WS} (Min)	t _{WS} (Max)
"000"	1.7	2.3	15.5	28.8	36.8
"001"	3.4	4.6	32.0	59.2	73.6
"010"	6.8	9.2	63.0	116.0	148.0
"011"	13.5	18.5	127.0	236.0	292.0
"100"	27.5	36.5	256.0	476.0	584.0
"101"	55.0	73.0	512.0	952.0	1168.0
"110"	110.0	146.0	1025.0	1904.0	2336.0
"111"	220.0	292.0	2050.0	3808.0	4664.0

4.9 WDT Function – continued

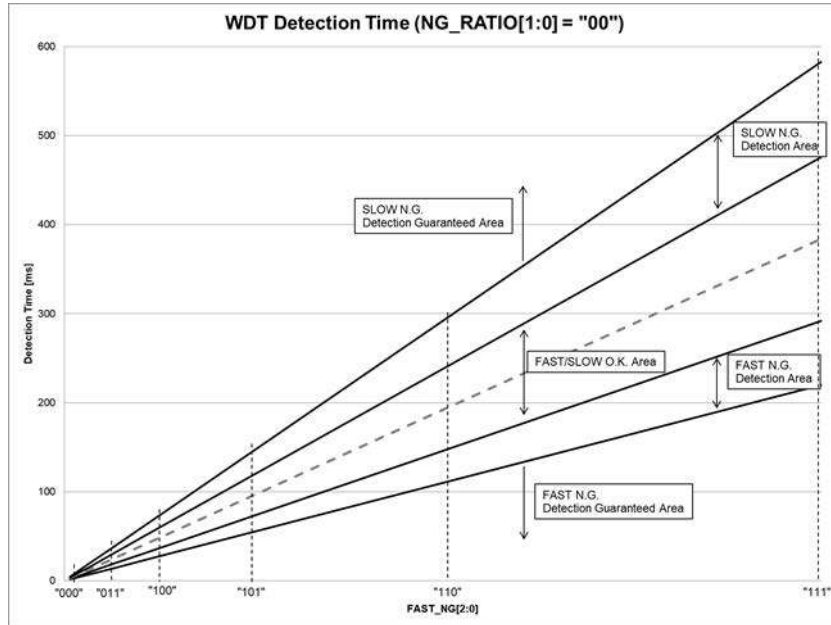

Figure 37. WDT Detection Time when NG_RATIO[1:0] = "00"

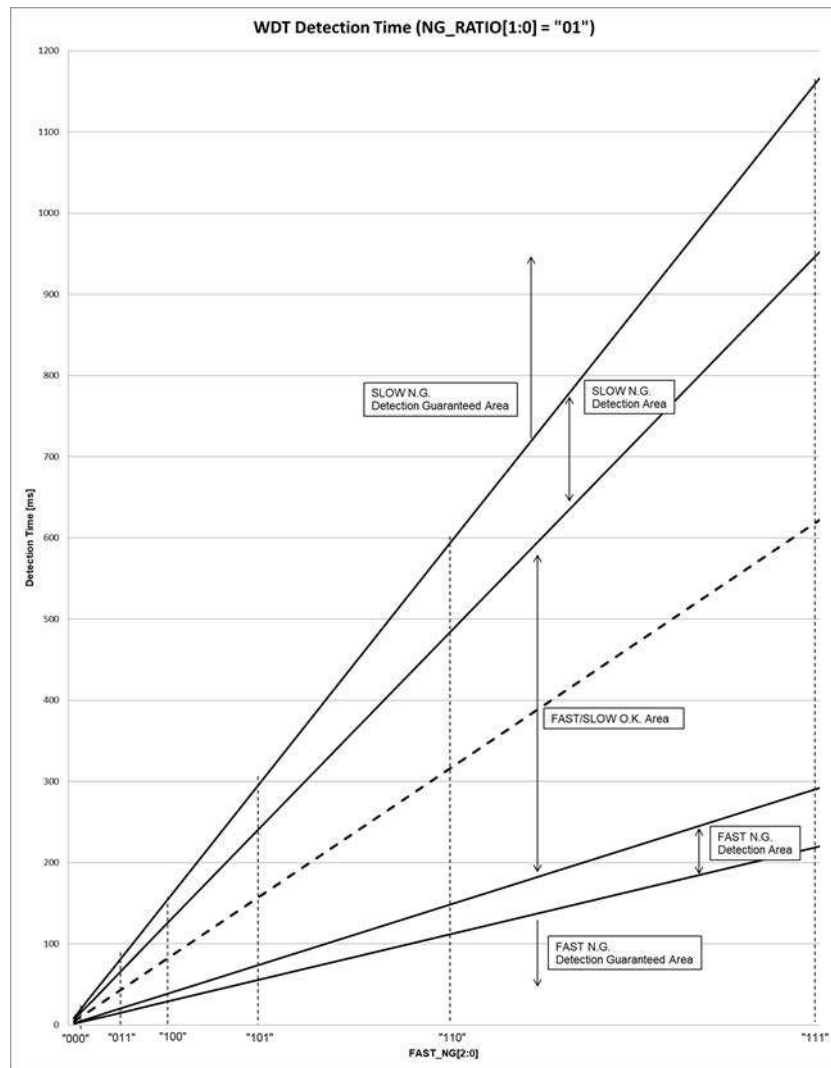

Figure 38. WDT Detection Time when NG_RATIO[1:0] = "01"

5. Register Specification

5.1 Register Map

...Initializes at either VIN reset (VFIL UVLO) or SEQ reset (STANDBY transition) ...Initializes only at VIN reset (VFIL UVLO)

Table 21: I2C I/F Register Map

Address	Register Name	Bit[7]	Bit[6]	Bit[5]	Bit[4]	Bit[3]	Bit[2]	Bit[1]	Bit[0]	R/W	Default		
0x00	Vendor Code	1	1	0	1	1	0	1	1	RO	0xDB		
0x01	Product Code	0	1	1	1	0	1	1	0	RO	0x76		
0x02	Product Revision	0	0	0	0	0	0	1	0	RO	0x02		
-	-	-	-	-	-	-	-	-	-	-	-		
0x10	I2C FuSa Mode	-	-	-	SMOD_read	-	-	I2C_SMOD[1:0]	-	R/W	0x00		
0x11	SHDN WriteProtect	SHDN_WP[7:0]								R/W	0x00		
0x12	SHDN Cnt	-	-	-	-	-	-	VREF_SHDN	OSC_SHDN	R/W	0x03		
0x13	SSCG Cnt	-	SSCG_PERI	SSCG_FORM[1:0]	-	-	-	-	SSCG_EN	R/W	0x00		
0x14	SMRB Write Protect	SMRB_WP[7:0]								R/W	0x00		
0x15	SMRB Cnt	-	-	-	SMRB_hist	-	-	-	SMRB_asrt	R/W	0x01		
0x16	Watch Dog Timer setting	-	-	TYPE	NG_RATIO[1:0]	FAST_NG[2:0]				R/W	0x20		
0x17	OSC Enable	-	-	-	-	-	-	-	OSC_EN	R/W	0x00		
0x18	PGD Setting	PGD_SETTING[5:0]								R/W	0x3F		
-	-	-	-	-	-	-	-	-	-	-	-		
0x20	PMIC Internal Status	-	-	-	NO_EEP	PMIC_STATE[3:0]				RO	0x00		
0x21	I2C MD2_E1 Bit 1	I2C_MD2_E1_BIT[7:0]								RO	0x00		
0x22	I2C MD2_E1 Bit 2	I2C_MD2_E1_BIT_P[4:0]								RO	0x00		
0x23	I2C / Thermal Error Status	-	-	TW	TSD	-	MD2_E2	MD2_E1	MD1	R/W	0x00		
0x24	I2C / Thermal Error Mask	-	-	TW_IMASK	-	-	-	-	I2C_IMASK	R/W	0x00		
0x25	OVP Error Status	-	-	VOUT1_OVP	-	VOUT4_OVP	VOUT3_OVP	VOUT2_OVP	VOUT1_OVP	R/W	0x00		
0x26	SCP Error Status	-	-	VOUT1_SCP	-	VOUT4_SCP	VOUT3_SCP	VOUT2_SCP	VOUT1_SCP	R/W	0x00		
0x27	OCF Error Status	LDSW_OCP	VOUTS1_OCP	-	VOUT4B_OCP	VOUT4A_OCP	VOUT3_OCP	VOUT2_OCP	VOUT1_OCP	R/W	0x00		
0x28	OVD Error Status	-	-	VOUT1_OVD	-	VOUT4_OVD	VOUT3_OVD	VOUT2_OVD	VOUT1_OVD	R/W	0x00		
0x29	UVD / OCW Error Status	-	VOUTS1_OGW	VOUT1_UVD	-	VOUT4_UVD	VOUT3_UVD	VOUT2_UVD	VOUT1_UVD	R/W	0x00		
0x2A	UVP Error Status	-	VIN7_UVP	VIN6_UVP	VIN5_UVP	VIN4_UVP	VIN3_UVP	VIN2_UVP	VIN1_UVP	R/W	0x00		
0x2B	System Status	V1_HUT_ERR	HUT_ERR	EEP_END	EEP_CRC_ERR	OSC_ERR	VREF_ERR	WDT_ERR	SD_ERR	R/W	0x00		
0x2C	System Status Mask	V1_HUT_E_IMASK	HUT_E_IMASK	EEP_END_IMASK	EEP_CRC_E_IMASK	OSC_E_IMASK	VREF_E_IMASK	WDT_E_IMASK	SD_E_IMASK	R/W	0x20		
-	-	-	-	-	-	-	-	-	-	-	-		
-	-	-	-	-	-	-	-	-	-	-	-		
0x30	INT IntReq	SYS_INT	UVP_INT	UVD_INT	OVD_INT	OCF_INT	SCP_INT	OVP_INT	I2CTHM_INT	R/W	0x00		
0x31	INT IntMask	SYS_IMASK	UVP_IMASK	UVD_IMASK	OVD_IMASK	OCF_IMASK	SCP_IMASK	OVP_IMASK	I2CTHM_IMASK	R/W	0x00		
-	-	-	-	-	-	-	-	-	-	-	-		
0x40	POW Write Protect	POW_WP[7:0]								R/W	0x00		
0x41	POW Trigger VOUT1	POFF_TRG_VOUT1[3:0]				PON_TRG_VOUT1[3:0]				R/W	0x20		
0x42	POW Trigger VOUT2	POFF_TRG_VOUT2[3:0]				PON_TRG_VOUT2[3:0]				R/W	0x61		
0x43	POW Trigger VOUT3	POFF_TRG_VOUT3[3:0]				PON_TRG_VOUT3[3:0]				R/W	0x45		
0x44	POW Trigger VOUT4	POFF_TRG_VOUT4[3:0]				PON_TRG_VOUT4[3:0]				R/W	0x73		
0x45	POW Trigger VOUTL1	POFF_TRG_VOUTL1[3:0]				PON_TRG_VOUTL1[3:0]				R/W	0x36		
0x46	POW Trigger VOUTS1	POFF_TRG_VOUTS1[3:0]				PON_TRG_VOUTS1[3:0]				R/W	0x52		
0x47	POW Trigger PRESETB	POFF_TRG_PRESETB[3:0]				PON_TRG_PRESETB[3:0]				R/W	0x04		
0x48	POW Wait VOUT1	POFF_WAIT_VOUT1[3:0]				PON_WAIT_VOUT1[3:0]				R/W	0x00		
0x49	POW Wait VOUT2	POFF_WAIT_VOUT2[3:0]				PON_WAIT_VOUT2[3:0]				R/W	0x00		
0x4A	POW Wait VOUT3	POFF_WAIT_VOUT3[3:0]				PON_WAIT_VOUT3[3:0]				R/W	0x00		
0x4B	POW Wait VOUT4	POFF_WAIT_VOUT4[3:0]				PON_WAIT_VOUT4[3:0]				R/W	0x00		
0x4C	POW Wait VOUTL1	POFF_WAIT_VOUTL1[3:0]				PON_WAIT_VOUTL1[3:0]				R/W	0x00		
0x4D	POW Wait VOUTS1	POFF_WAIT_VOUTS1[3:0]				PON_WAIT_VOUTS1[3:0]				R/W	0x00		
0x4E	POW Wait PRESETB	POFF_WAIT_PRESETB[3:0]				PON_WAIT_PRESETB[3:0]				R/W	0x00		
-	-	-	-	-	-	-	-	-	-	-	-		
0x50	VOUT1 TUNE	V1_SIGN	-	-	-	-	VOUT1_TUNE[2:0]			RO	0x00		
0x51	VOUT1 OVD SET	-	VOUT1_OVD_SET[6:0]					-			R/W	0x43	
0x52	VOUT1 UVD SET	-	VOUT1_UVD_SET[6:0]					-			R/W	0x43	
0x53	VOUT2 TUNE	V2_SIGN	-	-	-	-	VOUT2_TUNE[2:0]			RO	0x00		
0x54	VOUT2 OVD SET	-	VOUT2_OVD_SET[6:0]					-			R/W	0x37	
0x55	VOUT2 UVD SET	-	VOUT2_UVD_SET[6:0]					-			R/W	0x37	
0x56	VOUT3 TUNE	V3_SIGN	-	-	-	VOUT3_TUNE[4:0]				RO	0x00		
0x57	VOUT3 OVD SET	-	VOUT3_OVD_SET[6:0]					-			R/W	0x3E/0x27 (Note 1)	
0x58	VOUT3 UVD SET	-	VOUT3_UVD_SET[6:0]					-			R/W	0x23/0x27 (Note 2)	
0x59	VOUT4 TUNE	V4_SIGN	-	-	-	VOUT4_TUNE[4:0]				RO	0x00		
0x5A	VOUT4 OVD SET	-	VOUT4_OVD_SET[6:0]					-			R/W	0x19	
0x5B	VOUT4 UVD SET	-	VOUT4_UVD_SET[6:0]					-			R/W	0x19	
0x5C	VOUTL1 TUNE	V1_SIGN	-	-	-	-	VOUTL1_TUNE[2:0]			RO	0x00		
0x5D	VOUTL1 OVD SET	-	VOUTL1_OVD_SET[6:0]					-			R/W	0x40	
0x5E	VOUTL1 UVD SET	-	VOUTL1_UVD_SET[6:0]					-			R/W	0x40	
0x5F	VOUTS1 OCW SET	-	-	VOUTS1_OCW_SET[5:0]					-			R/W	0x10/0x06 (Note 3)
0x60	VOUTS1 OCP SET	-	-	VOUTS1_OCP_SET[5:0]					-			R/W	0x16/0x08 (Note 4)
0x61	Deglitch Time	-	UVD_OCW_DEG_TIM[2:0]			-	OVD_DEG_TIM[2:0]			R/W	0x33		

(Note) Please do not access to the address except above.

(Note 1) DDR_SEL (pin) = L: Default value is 0x3E.
DDR_SEL (pin) = H: Default value is 0x27.

(Note 2) DDR_SEL (pin) = L: Default value is 0x23.
DDR_SEL (pin) = H: Default value is 0x27.

(Note 3) GATECNT (pin) = L: Default value is 0x10.
GATECNT (pin) = H: Default value is 0x06.

(Note 4) GATECNT (pin) = L: Default value is 0x16.
GATECNT (pin) = H: Default value is 0x08.

5. Register Specification – continued

5.2 Register Description

5.2.1 Recognition Code Indicator

Register Name	Address	D7	D6	D5	D4	D3	D2	D1	D0	R/W	Default
Vendor Code	0x00	1	1	0	1	1	0	1	1	RO	0xDB

Vendor Recognition Code
0xDB: Rohm

Register Name	Address	D7	D6	D5	D4	D3	D2	D1	D0	R/W	Default
Product Code	0x01	0	1	1	1	0	1	1	0	RO	0x76

Product Recognition Code
0x76: BD9576MUF-C

Register Name	Address	D7	D6	D5	D4	D3	D2	D1	D0	R/W	Default
Product Revision	0x02	0	0	0	0	0	0	1	0	RO	0x02

Product Revision Recognition Code
0x02: Rev.2 Sample

5.2.2 FuSa Mode (Error Detection / Rectification Mode)

Register Name	Address	D7	D6	D5	D4	D3	D2	D1	D0	R/W	Default
I2C FuSa Mode	0x10	-	-	-	SMOD_read	-	-	I2C_SMOD[1:0]		R/W	0x00

I2C_SMOD[1:0] FuSa Mode Setting

“00”: General mode (NO FuSa mode) => Normal I2C format without FuSa byte.

“01”: FuSa mode type1

FuSa byte = Write data. (No error if 2 transferring data bytes are the same value.)

When error is detected

=> Do not execute writing and assert MD1 Interruption Factor bit of I2C / Thermal Error Status register.

(Assert the INTB pin output if I2C_IMASK mask is released by I2C / Thermal Error Mask register.)

“10”: FuSa mode type2

FuSa byte = ECC data. (Refer to section 4.5 I2C I/F for details regarding ECC mathematical operation specification)

As a result of ECC mathematical operation,

At 1 bit Error (Rectify error of relevant bit)

=> Execute rectification writing and assert MD2_E1 Interruption Factor bit of I2C / Thermal Error Status register.

(Assert the INTB pin output if I2C_IMASK mask is released by I2C / Thermal Error Mask register, and also indicate location of relevant bit on I2C MD2_E1 Bit1 register and I2C MD2_E1 Bit2 register (for P[4:0])).

At 2 bit Error (Error Detection)

=> Do not execute writing and assert MD2_E2 Interruption Factor bit of I2C / Thermal Error Status register.

(Assert the INTB pin output if I2C_IMASK mask is released by I2C / Thermal Error Mask register.)

“11”: Reserved

SMOD_read FuSa Mode Read Setting

0: FuSa Mode is applied only for I2C write data.

1: FuSa Mode is applied not only I2C write data, but also I2C read data.

5.2 Register Description - continued

5.2.3 Shutdown Control

Register Name	Address	D7	D6	D5	D4	D3	D2	D1	D0	R/W	Default
SHDN WriteProtect	0x11	SHDN_WP[7:0]								R/W	0x00

SHDN_WP[7:0] Protection register for VREF_SHDN and OSC_SHDN
 0x59: Access for SHDN Cnt is enabled.
 Others: Access for SHDN Cnt is disabled.

Register Name	Address	D7	D6	D5	D4	D3	D2	D1	D0	R/W	Default
SHDN Cnt	0x12	-	-	-	-	-	-	VREF_SHDN	OSC_SHDN	R/W	0x03

OSC_SHDN Shutdown selection when OSC Mutual Monitor Error occur

0: When OSC Mutual Monitor Error occur, OSC_ERR System Error Status Register is written "1".
 1: When OSC Mutual Monitor Error occur, OSC_ERR System Error Status Register is written "1", and every output power is turned off at once. Internal state transitions to STANDBY.

VREF_SHDN Shutdown selection when VREF Mutual Monitor Error occur

0: When VREF Mutual Monitor Error occur, VREF_ERR System Error Status Register is written "1".
 1: When VREF Mutual Monitor Error occur, VREF_ERR System Error Status Register is written "1", and every output power is turned off at once. Internal state transitions to STANDBY.

5.2.4 Spread Spectrum Clock Generation Control for Internal OSC

BD9576MUF-C has built-in SSCG (Spread Spectrum Clock Generator) with center spread.

Register Name	Address	D7	D6	D5	D4	D3	D2	D1	D0	R/W	Default
SSCG Cnt	0x13	-	SSCG_PERI	SSCG_FORM[1:0]		-	-	-	SSCG_EN	R/W	0x00

SSCG_EN Enable signal of SSCG
 0: SSCG Disable
 1: SSCG Enable

SSCG_FORM[1:0] Selection of SSCG modulation waveform
 "00": Normal Triangle
 "01": Original waveform1 (A:B:C = 4:1:4)
 "10": Original waveform2 (A:B:C = 3:3:3)
 "11": Original waveform3 (A:B:C = 2:5:2)

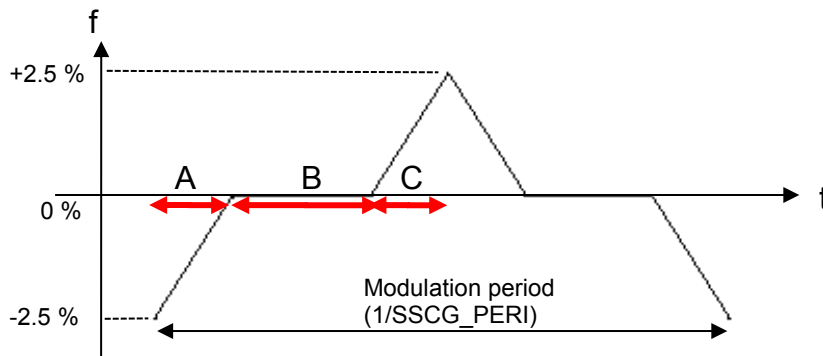

Figure 39. Modulation Waveform of SSCG

SSCG_PERI
 0: 122 Hz
 1: 7.813 kHz

5.2 Register Description - continued

5.2.5 SMRB Control Using I2C Control (Software Manual Reset for PRESETB)

The PRESETB pin output can be controlled by these registers.

Register Name	Address	D7	D6	D5	D4	D3	D2	D1	D0	R/W	Default
SMRB Write Protect	0x14	SMRB_WP[7:0]								R/W	0x00

SMRB_WP[7:0] Protection register for SMRB_asrt (Software Manual Reset for PRESETB)
 0x9D: SMRB assert is enabled.
 Others: SMRB assert is disabled.

Register Name	Address	D7	D6	D5	D4	D3	D2	D1	D0	R/W	Default
SMRB Cnt	0x15	-	-	-	SMRB_hist	-	-	-	SMRB_asrt	R/W	0x01

SMRB_asrt SMRB assert register
 When this register is set to "0", PRESETB is asserted to L. After 5 ms, this register value is reset to "1" and PRESETB is negated to H automatically.

SMRB_hist SMRB status register
 If SMRB assert is occurred, this register is set to "1". Register value does not be initialized during STANDBY state transition. Clear condition is I2C writing "1" or UVLO.

5.2.6 Watch Dog Timer setting

Register Name	Address	D7	D6	D5	D4	D3	D2	D1	D0	R/W	Default
Watch Dog Timer setting	0x16	-	-	TYPE	NG_RATIO[1:0]		FAST_NG[2:0]			R/W	0x20

FAST_NG[2:0], NG_RATIO[1:0] WDT N.G. detection area setting
 Regarding these registers' function, please refer to section 4.9 WDT Function.

TYPE WDT detecting type setting
 0: timeout detection (SLOW N.G.)
 1: window detection (FAST/SLOW N.G.)

(Note) I2C write to Watch Dog Timer setting register when the WDEN pin H level is prohibited.

5.2.7 Oscillator Enable in STANDBY State

Register Name	Address	D7	D6	D5	D4	D3	D2	D1	D0	R/W	Default
OSC Enable	0x17	-	-	-	-	-	-	-	OSC_EN	R/W	0x00

OSC_EN Oscillator Enable/Disable Selection in STANDBY state
 0: Oscillator Disable in STANDBY state
 1: Oscillator Enable in STANDBY state

(Note) For I2C write condition in STANDBY state, 110 μs (Max) wait time after OSC_EN register = "1" is needed.

5.2 Register Description - continued

5.2.8 The PGD Pin Output Assert Condition Setting

Register Name	Address	D7	D6	D5	D4	D3	D2	D1	D0	R/W	Default
PGD Setting	0x18	-	-	PGD_SETTING[5:0]						R/W	0x3F

PGD_SETTING[5:0] The PGD pin output assert condition
 PGD_SETTING[0] = 0: VOUT1 PGD is not the factor of the PGD pin output,
 1: VOUT1 PGD is the factor of the PGD pin output.
 PGD_SETTING[1] = 0: VOUT2 PGD is not the factor of the PGD pin output,
 1: VOUT2 PGD is the factor of the PGD pin output.
 PGD_SETTING[2] = 0: VOUT3 PGD is not the factor of the PGD pin output,
 1: VOUT3 PGD is the factor of the PGD pin output.
 PGD_SETTING[3] = 0: VOUT4 PGD is not the factor of the PGD pin output,
 1: VOUT4 PGD is the factor of the PGD pin output.
 PGD_SETTING[4] = 0: VOUTL1 PGD is not the factor of the PGD pin output,
 1: VOUTL1 PGD is the factor of the PGD pin output.
 PGD_SETTING[5] = 0: VOUTS1 PGD is not the factor of the PGD pin output,
 1: VOUTS1 PGD is the factor of the PGD pin output.

For example, the PGD pin output is asserted by VOUT1, VOUT2, VOUT3 and VOUT4 PGD when PGD_SETTING[5:0] = 0x0F.
 In this case, the PGD pin output is negated at any one of VOUT1, VOUT2, VOUT3 or VOUT4 discharge start timing.

5.2.9 PMIC Internal Status

Register Name	Address	D7	D6	D5	D4	D3	D2	D1	D0	R/W	Default
PMIC Internal Status	0x20	-	-	-	NO_EEP	PMIC_STATE[3:0]			RO	0x00	

PMIC_STATE[3:0] PMIC Internal State
 PMIC Internal State is shown in the following table.

Table 22: PMIC Internal State

PMIC_STATE[3:0] Setting Value	PMIC Internal State
0x0	SHUTDOWN
0x1	STANDBY
0x2	OSC Stable
0x3	Self Diagnosis
0x4	Power-ON STANDBY
0x5	Power-ON
0x6	ACTIVE
0x7	Power-OFF
0x8	Power-OFF STANDBY
0x9 to 0xF	State transition

NO_EEP Judgement for EEPROM installation
 0: With ACK from EEPROM (EEPROM is installed)
 1: Without ACK from EEPROM (EEPROM is not installed)

5.2 Register Description - continued

5.2.10 I2C FuSa Mode Error Bit Location

Register Name	Address	D7	D6	D5	D4	D3	D2	D1	D0	R/W	Default
I2C MD2_E1 Bit 1	0x21	I2C_MD2_E1_BIT[7:0]								RO	0x00

I2C_MD2_E1_BIT[7:0] Error bit location at FuSa mode type2

Set "1" to the bit location where error is detected and rectified in FuSa mode type2.

Register Name	Address	D7	D6	D5	D4	D3	D2	D1	D0	R/W	Default
I2C MD2_E1 Bit 2	0x22	-	-	-	I2C_MD2_E1_BIT_P[4:0]					RO	0x00

I2C_MD2_E1_BIT_P[4:0] Error bit location (P code) at FuSa mode type2

Set "1" to the bit (P code value) location where error is detected and rectified in FuSa mode type2.

5.2 Register Description – continued

5.2.11 INTB Interruption Factor and Mask Condition

(Note) Clear condition of Status registers is I2C writing “1” or UVLO.

Register Name	Address	D7	D6	D5	D4	D3	D2	D1	D0	R/W	Default
I2C / Thermal Error Status	0x23	-	-	TW	TSD	-	MD2_E2	MD2_E1	MD1	R/W	0x00

MD1 I2C Write Error Status in FuSa Mode Type1

0: No Interruption Factor
1: with Interruption Factor

MD2_E1 I2C Write Error Status in FuSa Mode Type2 with 1 bit error

0: No Interruption Factor
1: with Interruption Factor

MD2_E2 I2C Write Error Status in FuSa Mode Type2 with more than 2 bit error

0: No Interruption Factor
1: with Interruption Factor

TSD Thermal Shutdown Detection

0: No Interruption Factor
1: with Interruption Factor

TW Thermal Warning Detection

0: No Interruption Factor
1: with Interruption Factor

Register Name	Address	D7	D6	D5	D4	D3	D2	D1	D0	R/W	Default
I2C / Thermal Error Mask	0x24	-	-	TW_IMASK	-	-	-	-	I2C_IMASK	R/W	0x00

I2C_IMASK FuSa Mode Error (MD1, MD2_E1, MD2_E2) Interruption Factor Mask

0: Mask Disable
1: Mask Enable

TW_IMASK Thermal Warning Interruption Factor Mask

0: Mask Disable
1: Mask Enable

Register Name	Address	D7	D6	D5	D4	D3	D2	D1	D0	R/W	Default
OVP Error Status	0x25	-	-	VOUTL1_OVP	-	VOUT4_OVP	VOUT3_OVP	VOUT2_OVP	VOUT1_OVP	R/W	0x00

VOUT_x_OVP (x = 1 to 4 and L1) Over Voltage Protection Detection

0: No Interruption Factor
1: with Interruption Factor

Register Name	Address	D7	D6	D5	D4	D3	D2	D1	D0	R/W	Default
SCP Error Status	0x26	-	-	VOUTL1_SCP	-	VOUT4_SCP	VOUT3_SCP	VOUT2_SCP	VOUT1_SCP	R/W	0x00

VOUT_x_SCP (x = 1 to 4 and L1) Short Circuit Protection Detection

0: No Interruption Factor
1: with Interruption Factor

Register Name	Address	D7	D6	D5	D4	D3	D2	D1	D0	R/W	Default
OCP Error Status	0x27	LDSW_OCP	VOUTS1_OCP	-	VOUT4B_OCP	VOUT4A_OCP	VOUT3_OCP	VOUT2_OCP	VOUT1_OCP	R/W	0x00

VOUT_x_OCP (x = 1 to 3, 4A, 4B and S1), LDSW_OCP Over Current Protection Detection

0: No Interruption Factor
1: with Interruption Factor

5.2.11 INTB Interruption Factor and Mask Condition – continued

Register Name	Address	D7	D6	D5	D4	D3	D2	D1	D0	R/W	Default
OVD Error Status	0x28	-	-	VOUTL1_OVD	-	VOUT4_OVD	VOUT3_OVD	VOUT2_OVD	VOUT1_OVD	R/W	0x00

VOUTx_OVD (x = 1 to 4 and L1) Over Voltage Detection
 0: No Interruption Factor
 1: with Interruption Factor

Register Name	Address	D7	D6	D5	D4	D3	D2	D1	D0	R/W	Default
UVD / OCW Error Status	0x29	-	VOUTS1_OCW	VOUTL1_UVD	-	VOUT4_UVD	VOUT3_UVD	VOUT2_UVD	VOUT1_UVD	R/W	0x00

VOUTx_UVD (x = 1 to 4 and L1) Under Voltage Detection
 0: No Interruption Factor
 1: with Interruption Factor

VOUTS1_OCW Over Current Warning
 0: No Interruption Factor
 1: with Interruption Factor

Register Name	Address	D7	D6	D5	D4	D3	D2	D1	D0	R/W	Default
UVP Error Status	0x2A	-	VIN7_UVP	VIN6_UVP	VIN5_UVP	VIN4_UVP	VIN3_UVP	VIN2_UVP	VIN1_UVP	R/W	0x00

VINx_UVP (x = 1 to 7) Under Voltage Protection
 0: No Interruption Factor
 1: with Interruption Factor

Register Name	Address	D7	D6	D5	D4	D3	D2	D1	D0	R/W	Default
System Status	0x2B	V1_HUT_ERR	HUT_ERR	EEP_END	EEP_CRC_ERR	OSC_ERR	VREF_ERR	WDT_ERR	SD_ERR	R/W	0x00

SD_ERR Self Diagnosis Error
 0: No Interruption Factor
 1: with Interruption Factor

WDT_ERR Watch Dog Timer Error
 0: No Interruption Factor
 1: with Interruption Factor

VREF_ERR Reference Voltage Mutual Monitor Error
 0: No Interruption Factor
 1: with Interruption Factor

OSC_ERR Oscillator Mutual Monitor Error
 0: No Interruption Factor
 1: with Interruption Factor

EEP_CRC_ERR CRC Error during EEPROM Load
 0: No Interruption Factor
 1: with Interruption Factor

EEP_END Notification of EEPROM Load Internal State completion
 0: Before EEPROM Load Completion
 1: EEPROM Load is completed

HUT_ERR Power-OFF Sequence Hang-Up Timer counts over 400 ms
 0: No Interruption Factor
 1: with Interruption Factor

V1_HUT_ERR V1 Power-OFF Hang-Up Timer counts over 100 ms
 0: No Interruption Factor
 1: with Interruption Factor

5.2.11 INTB Interruption Factor and Mask Condition - continued

Register Name	Address	D7	D6	D5	D4	D3	D2	D1	D0	R/W	Default
System Status Mask	0x2C	V1_HUT_E_IMASK	HUT_E_IMASK	EEP_END_IMASK	EEPCRC_E_IMASK	OSC_E_IMASK	VREF_E_IMASK	WDT_E_IMASK	SD_E_IMASK	R/W	0x20

SD_E_IMASK 0: Mask Disable 1: Mask Enable	Self Diagnosis Error Interruption Factor Mask
WDT_E_IMASK 0: Mask Disable 1: Mask Enable	Watch Dog Timer Error Interruption Factor Mask
VREF_E_IMASK 0: Mask Disable 1: Mask Enable	Reference Voltage Mutual Monitor Error Interruption Factor Mask
OSC_E_IMASK 0: Mask Disable 1: Mask Enable	Oscillator Mutual Monitor Error Interruption Factor Mask
EEPCRC_E_IMASK 0: Mask Disable 1: Mask Enable	CRC Error during EEPROM Load Interruption Factor Mask
EEP_END_IMASK 0: Mask Disable 1: Mask Enable	Notification of EEPROM Load Internal State completion Interruption Factor Mask
HUT_E_IMASK 0: Mask Disable 1: Mask Enable	Hang-Up Timer Interruption Factor Mask
V1_HUT_E_IMASK 0: Mask Disable 1: Mask Enable	V1 Hang-Up Timer Interruption Factor Mask

5.2.11 INTB Interruption Factor and Mask Condition - continued

Register Name	Address	D7	D6	D5	D4	D3	D2	D1	D0	R/W	Default
INT IntReq	0x30	SYS_INT	UVP_INT	UVD_INT	OVD_INT	OCP_INT	SCP_INT	OVP_INT	I2CTHM_INT	R/W	0x00

I2CTHM_INT Primary Level Interruption Factor of I2C / Thermal Error Status Register

0: No Interruption Factor
1: with Interruption Factor

OVP_INT Primary Level Interruption Factor of OVP Error Status Register

0: No Interruption Factor
1: with Interruption Factor

SCP_INT Primary Level Interruption Factor of SCP Error Status Register

0: No Interruption Factor
1: with Interruption Factor

OCP_INT Primary Level Interruption Factor of OCP Error Status Register

0: No Interruption Factor
1: with Interruption Factor

OVD_INT Primary Level Interruption Factor of OVD Error Status Register

0: No Interruption Factor
1: with Interruption Factor

UVD_INT Primary Level Interruption Factor of UVD Error Status Register

0: No Interruption Factor
1: with Interruption Factor

UVP_INT Primary Level Interruption Factor of UVP Error Status Register

0: No Interruption Factor
1: with Interruption Factor

SYS_INT Primary Level Interruption Factor of System Status Register

0: No Interruption Factor
1: with Interruption Factor

5.2.11 INTB Interruption Factor and Mask Condition - continued

Register Name	Address	D7	D6	D5	D4	D3	D2	D1	D0	R/W	Default
INT IntMask	0x31	SYS_ IMASK	UVP_ IMASK	UVD_ IMASK	OVD_ IMASK	OCP_ IMASK	SCP_ IMASK	OVP_ IMASK	I2CTHM_ IMASK	R/W	0x00

I2CTHM_IMASK 0: Mask Disable 1: Mask Enable	Primary Level Interruption Factor of I2C / Thermal Error Status Register Mask
OVP_IMASK 0: Mask Disable 1: Mask Enable	Primary Level Interruption Factor of OVP Error Status Register Mask
SCP_IMASK 0: Mask Disable 1: Mask Enable	Primary Level Interruption Factor of SCP Error Status Register Mask
OCP_IMASK 0: Mask Disable 1: Mask Enable	Primary Level Interruption Factor of OCP Error Status Register Mask
OVD_IMASK 0: Mask Disable 1: Mask Enable	Primary Level Interruption Factor of OVD Error Status Register Mask
UVD_IMASK 0: Mask Disable 1: Mask Enable	Primary Level Interruption Factor of UVD Error Status Register Mask
UVP_IMASK 0: Mask Disable 1: Mask Enable	Primary Level Interruption Factor of UVP Error Status Register Mask
SYS_IMASK 0: Mask Disable 1: Mask Enable	Primary Level Interruption Factor of System Status Register Mask

5.2 Register Description – continued

5.2.12 POW Setting

Register Name	Address	D7	D6	D5	D4	D3	D2	D1	D0	R/W	Default
POW WriteProtect	0x40	POW_WP[7:0]								R/W	0x00

POW_WP[7:0] Protection register for POW Trigger and POW Wait
 0xAB: Access for POW registers is enabled.
 Others: Access for POW registers is disabled.

Register Name	Address	D7	D6	D5	D4	D3	D2	D1	D0	R/W	Default
POW Trigger VOUT1	0x41	POFF_TRG_VOUT1				PON_TRG_VOUT1				R/W	0x20

Register Name	Address	D7	D6	D5	D4	D3	D2	D1	D0	R/W	Default
POW Trigger VOUT2	0x42	POFF_TRG_VOUT2				PON_TRG_VOUT2				R/W	0x61

Register Name	Address	D7	D6	D5	D4	D3	D2	D1	D0	R/W	Default
POW Trigger VOUT3	0x43	POFF_TRG_VOUT3				PON_TRG_VOUT3				R/W	0x45

Register Name	Address	D7	D6	D5	D4	D3	D2	D1	D0	R/W	Default
POW Trigger VOUT4	0x44	POFF_TRG_VOUT4				PON_TRG_VOUT4				R/W	0x73

Register Name	Address	D7	D6	D5	D4	D3	D2	D1	D0	R/W	Default
POW Trigger VOUTL1	0x45	POFF_TRG_VOUTL1				PON_TRG_VOUTL1				R/W	0x36

Register Name	Address	D7	D6	D5	D4	D3	D2	D1	D0	R/W	Default
POW Trigger VOUTS1	0x46	POFF_TRG_VOUTS1				PON_TRG_VOUTS1				R/W	0x52

Register Name	Address	D7	D6	D5	D4	D3	D2	D1	D0	R/W	Default
POW Trigger PRESETB	0x47	POFF_TRG_PRESETB				PON_TRG_PRESETB				R/W	0x04

PON_TRG_VOUT_x^(Note 1) Trigger Signal Setting in Power-ON Sequence

POFF_TRG_VOUT_x^(Note 1) Trigger Signal Setting in Power-OFF Sequence

The Order of Power-ON Sequence and Power-OFF Sequence is selected by POW Trigger VOUT_x^(Note 1) registers. POW Trigger VOUT_x^(Note 1) registers' value can be changed by EEPROM. Regarding default value of each registers, please refer register map.

(e.g.)

By setting PON_TRG_VOUT2 = 0x1 (VOUT1 Enable Signal), VOUT2 starts Power-ON after VOUT1.

By setting POFF_TRG_VOUTL1 = 0x03 (VOUT3 Enable Signal), VOUTL1 starts Power-OFF after VOUT3.

By setting PON_TRG_VOUTL1 = 0xFF (Always OFF Setting), VOUTL1 never Power-ON. In this case, VOUTL1 is excluded from the Power-ON / Power-OFF sequence automatically.

Setting over 2 signals triggering one Enable Signal is prohibited.

(Note 1) VOUT_x = VOUT1 to VOUT4, VOUTL1 and VOUTS1

5.2.12 POW Setting – continued

Table 23: PON/POFF Trigger Signal

PON_TRG_VOUT _x ^(Note 1) / POFF_TRG_VOUT _x ^(Note 1) PON_TRG_PRESETB / POFF_TRG_PRESETB	Trigger Signal
0x0	RSTB (pin) = H level (Power-ON) / L level (Power-OFF)
0x1	VOUT1 Enable Signal
0x2	VOUT2 Enable Signal
0x3	VOUT3 Enable Signal
0x4	VOUT4 Enable Signal
0x5	VOU _T L1 Enable Signal
0x6	VOU _T S1 Enable Signal
0x7	PRESETB (pin)
0x8 to 0xF	Always OFF Setting

Register Name	Address	D7	D6	D5	D4	D3	D2	D1	D0	R/W	Default
POW Wait VOUT1	0x48	POFF_WAIT_VOUT1				PON_WAIT_VOUT1				R/W	0x00

Register Name	Address	D7	D6	D5	D4	D3	D2	D1	D0	R/W	Default
POW Wait VOUT2	0x49	POFF_WAIT_VOUT2				PON_WAIT_VOUT2				R/W	0x00

Register Name	Address	D7	D6	D5	D4	D3	D2	D1	D0	R/W	Default
POW Wait VOUT3	0x4A	POFF_WAIT_VOUT3				PON_WAIT_VOUT3				R/W	0x00

Register Name	Address	D7	D6	D5	D4	D3	D2	D1	D0	R/W	Default
POW Wait VOUT4	0x4B	POFF_WAIT_VOUT4				PON_WAIT_VOUT4				R/W	0x00

Register Name	Address	D7	D6	D5	D4	D3	D2	D1	D0	R/W	Default
POW Wait VOU _T L1	0x4C	POFF_WAIT_VOU _T L1				PON_WAIT_VOU _T L1				R/W	0x00

Register Name	Address	D7	D6	D5	D4	D3	D2	D1	D0	R/W	Default
POW Wait VOU _T S1	0x4D	POFF_WAIT_VOU _T S1				PON_WAIT_VOU _T S1				R/W	0x00

Register Name	Address	D7	D6	D5	D4	D3	D2	D1	D0	R/W	Default
POW Wait PRESETB	0x4E	POFF_WAIT_PRESETB				PON_WAIT_PRESETB				R/W	0x00

PON_WAIT_VOUT_x^(Note 1) Interval Setting in Power-ON Sequence

POFF_WAIT_VOUT_x^(Note 1) Interval Setting in Power-OFF Sequence

The Interval of Power-ON Sequence and Power-OFF Sequence is selected by POW Wait VOUT_x^(Note 1) registers. POW Wait VOUT_x^(Note 1) registers' value can be changed by EEPROM. Regarding default value of each registers, please refer register map.

(Note 1) VOUT_x = VOUT1 to VOUT4, VOU_TL1 and VOU_TS1

5.2.12 POW Setting – continued

Table 24: PON/POFF Interval

PON_WAIT_VOUTx ^(Note 1) / POFF_WAIT_VOUTx ^(Note 1) PON_WAIT_PRESETB / POFF_WAIT_PRESETB	Interval
0x0	2 μs
0x1	500 μs
0x2	1 ms
0x3	2 ms
0x4	4 ms
0x5	5 ms
0x6	8 ms
0x7	10 ms
0x8	15 ms
0x9	20 ms
0xA	25 ms
0xB	30 ms
0xC	40 ms
0xD	45 ms
0xE	50 ms
0xF	60 ms

Please set Power-OFF interval not to exceed totally 400 ms (Power-OFF Sequence Hang Up Timer).

(Note 1) VOUTx = VOUT1 to VOUT4, VOUTL1 and VOUTS1

5.2 Register Description – continued

5.2.13 VOUT Voltage Tune / OVD SET / UVD SET

These VOUT voltage tuning registers are set via external EEPROM.

Register Name	Address	D7	D6	D5	D4	D3	D2	D1	D0	R/W	Default
VOUT1 TUNE	0x50	V1_SIGN	-	-	-	-	VOUT1_TUNE[2:0]			RO	0x00

V1_SIGN VOUT1 Sign Bit
 0: Plus
 1: Minus

VOUT1_TUNE[2:0] VOUT1 Tuning Bit
 VOUT1 output voltage is tuned from default value (5.0 V) by these registers. Step: 100 mV.

Table 25: VOUT1 Tuning Voltage

VOUT1_TUNE[2:0]	Tuning Voltage (mV)
0x0	0
0x1	100
0x2	200
0x3	300
0x4	400
0x5	500
0x6	Clipped to 500
0x7	Clipped to 500

Register Name	Address	D7	D6	D5	D4	D3	D2	D1	D0	R/W	Default	
VOUT1 OVD SET	0x51	-	VOUT1_OVD_SET[6:0]								R/W	0x43

VOUT1_OVD_SET[6:0] VOUT1 OVD setting. Step: 5 mV default 0x43: 340 mV
 By setting this register as 0x00, VOUT1 OVD function is disabled.

Table 26: VOUT1 OVD Voltage

VOUT1_OVD_SET[6:0]	OVD Voltage (mV)
0x00	Function Disable
0x01 to 0x2B	Clipped to 225
0x2C	225
0x2D	230
.....
.....
0x54	425
0x55 to 0x7F	Clipped to 425

5.2.13 VOUT Voltage Tune / OVD SET / UVD SET - continued

Register Name	Address	D7	D6	D5	D4	D3	D2	D1	D0	R/W	Default	
VOUT1 UVD SET	0x52	-	VOUT1_UVD_SET[6:0]								R/W	0x43

VOUT1_UVD_SET[6:0] VOUT1 UVD setting. Step: 5 mV default 0x43: 340 mV
By setting this register as 0x00, VOUT1 UVD function is disabled.

Table 27: VOUT1 UVD Voltage

VOUT1_UVD_SET[6:0]	UVD Voltage (mV)
0x00	Function Disable
0x01 to 0x2B	Clipped to 225
0x2C	225
0x2D	230
.....
.....
0x54	425
0x55 to 0x7F	Clipped to 425

Register Name	Address	D7	D6	D5	D4	D3	D2	D1	D0	R/W	Default
VOUT2 TUNE	0x53	V2_SIGN	-	-	-	-	VOUT2_TUNE[2:0]			RO	0x00

V2_SIGN VOUT2 Sign Bit
0: Plus
1: Minus

VOUT2_TUNE[2:0] VOUT2 Tuning Bit
VOUT2 output voltage is tuned from default value (1.8 V) by these registers. Step: 20 mV.

Table 28: VOUT2 Tuning Voltage

VOUT2_TUNE[2:0]	Tuning Voltage (mV)
0x0	0
0x1	20
0x2	40
0x3	60
0x4	80
0x5	100
0x6	120
0x7	140

Register Name	Address	D7	D6	D5	D4	D3	D2	D1	D0	R/W	Default	
VOUT2 OVD SET	0x54	-	VOUT2_OVD_SET[6:0]								R/W	0x37

VOUT2_OVD_SET[6:0] VOUT2 OVD setting. Step: 1 mV default 0x37: 56 mV
By setting this register as 0x00, VOUT2 OVD function is disabled.

Table 29: VOUT2 OVD Voltage

VOUT2_OVD_SET[6:0]	OVD Voltage (mV)
0x00	Function Disable
0x01 to 0x0F	Clipped to 17
0x10	17
0x11	18
.....
.....
0x6D	110
0x6E to 0x7F	Clipped to 110

5.2.13 VOUT Voltage Tune / OVD SET / UVD SET - continued

Register Name	Address	D7	D6	D5	D4	D3	D2	D1	D0	R/W	Default	
VOUT2 UVD SET	0x55	-	VOUT2_UVD_SET[6:0]								R/W	0x37

VOUT2_UVD_SET[6:0] VOUT2 UVD setting. Step: 1 mV default 0x37: 56 mV
 By setting this register as 0x00, VOUT2 UVD function is disabled.

Table 30: VOUT2 UVD Voltage

VOUT2_UVD_SET[6:0]	UVD Voltage (mV)
0x00	Function Disable
0x01 to 0x0F	Clipped to 17
0x10	17
0x11	18
.....
.....
0x6D	110
0x6E to 0x7F	Clipped to 110

Register Name	Address	D7	D6	D5	D4	D3	D2	D1	D0	R/W	Default	
VOUT3 TUNE	0x56	V3_SIGN	-	-	VOUT3_TUNE[4:0]						RO	0x00

V3_SIGN VOUT3 Sign Bit
 0: Plus
 1: Minus

VOUT3_TUNE[4:0] VOUT3 Tuning Bit
 VOUT3 output voltage is tuned from default value (1.35 V, 1.5 V) by these registers. Step: 10 mV.

Table 31: VOUT3 Tuning Voltage

VOUT3_TUNE[4:0]	Tuning Voltage (mV)
0x0	0
0x1	10
0x2	20
.....
.....
0x1D	290
0x1E	300
0x1F	310

5.2.13 VOUT Voltage Tune / OVD SET / UVD SET - continued

Register Name	Address	D7	D6	D5	D4	D3	D2	D1	D0	R/W	Default	
VOUT3 OVD SET	0x57	-	VOUT3_OVD_SET[6:0]								R/W	0x3E/0x27

VOUT3_OVD_SET[6:0] VOUT3 OVD setting. Step: 1mV
 By setting this register as 0x00, VOUT3 OVD function is disabled.
 Default value is determined by DDR_SEL (pin) condition.
 DDR_SEL (pin) = L: Default value is 0x3E (63 mV).
 DDR_SEL (pin) = H: Default value is 0x27 (40 mV).

Table 32: VOUT3 OVD Voltage

VOUT3_OVD_SET[6:0]	OVD Voltage (mV)
0x00	Function Disable
0x01 to 0x0F	Clipped to 17
0x10	17
0x11	18
.....
.....
0x6D	110
0x6E to 0x7F	Clipped to 110

Register Name	Address	D7	D6	D5	D4	D3	D2	D1	D0	R/W	Default	
VOUT3 UVD SET	0x58	-	VOUT3_UVD_SET[6:0]								R/W	0x23/0x27

VOUT3_UVD_SET[6:0] VOUT3 UVD setting. Step: 1mV
 By setting this register as 0x00, VOUT3 UVD function is disabled.
 Default value is determined by DDR_SEL (pin) condition.
 DDR_SEL (pin) = L: Default value is 0x23 (36 mV).
 DDR_SEL (pin) = H: Default value is 0x27 (40 mV).

Table 33: VOUT3 UVD Voltage

VOUT3_UVD_SET[6:0]	UVD Voltage (mV)
0x00	Function Disable
0x01 to 0x0F	Clipped to 17
0x10	17
0x11	18
.....
.....
0x6D	110
0x6E to 0x7F	Clipped to 110

5.2.13 VOUT Voltage Tune / OVD SET / UVD SET - continued

Register Name	Address	D7	D6	D5	D4	D3	D2	D1	D0	R/W	Default	
VOUT4 TUNE	0x59	V4_SIGN	-	-	VOUT4_TUNE[4:0]						RO	0x00

V4_SIGN VOUT4 Sign Bit
 0: Plus
 1: Minus

VOUT4_TUNE[4:0] VOUT4 Tuning Bit
 VOUT4 output voltage is tuned from default value (1.03 V) by these registers. Step: 10 mV.

Table 34: VOUT4 Tuning Voltage

VOUT4_TUNE[4:0]	Tuning Voltage (mV)
0x0	0
0x1	10
0x2	20
.....
.....
0x1D	290
0x1E	300
0x1F	310

Register Name	Address	D7	D6	D5	D4	D3	D2	D1	D0	R/W	Default	
VOUT4 OVD SET	0x5A	-	VOUT4_OVD_SET[6:0]								R/W	0x19

VOUT4_OVD_SET[6:0] VOUT4 OVD setting. Step: 1 mV default 0x19: 26 mV
 By setting this register as 0x00, VOUT4 OVD function is disabled.

Table 35: VOUT4 OVD Voltage

VOUT4_OVD_SET[6:0]	OVD Voltage (mV)
0x00	Function Disable
0x01 to 0x0F	Clipped to 17
0x10	17
0x11	18
.....
.....
0x6D	110
0x6E to 0x7F	Clipped to 110

Register Name	Address	D7	D6	D5	D4	D3	D2	D1	D0	R/W	Default	
VOUT4 UVD SET	0x5B	-	VOUT4_UVD_SET[6:0]								R/W	0x19

VOUT4_UVD_SET[6:0] VOUT4 UVD setting. Step: 1mV default 0x19: 26 mV
 By setting this register as 0x00, VOUT4 UVD function is disabled.

Table 36: VOUT4 UVD Voltage

VOUT4_UVD_SET[6:0]	UVD Voltage (mV)
0x00	Function Disable
0x01 to 0x0F	Clipped to 17
0x10	17
0x11	18
.....
.....
0x6D	110
0x6E to 0x7F	Clipped to 110

5.2.13 VOUTL1 Voltage Tune / OVD SET / UVD SET - continued

Register Name	Address	D7	D6	D5	D4	D3	D2	D1	D0	R/W	Default
VOUTL1 TUNE	0x5C	VL1_SIGN	-	-	-	-	VOUTL1_TUNE[2:0]			RO	0x00

VL1_SIGN VOUTL1 Sign Bit
 0: Plus
 1: Minus

VOUTL1_TUNE[2:0] VOUTL1 Tuning Bit
 VOUTL1 output voltage is tuned from default value (2.5 V) by these registers. Step: 40 mV.

Table 37: VOUTL1 Tuning Voltage

VOUTL1_TUNE[2:0]	Tuning Voltage (mV)
0x0	0
0x1	40
0x2	80
0x3	120
0x4	160
0x5	200
0x6	240
0x7	280

Register Name	Address	D7	D6	D5	D4	D3	D2	D1	D0	R/W	Default
VOUTL1 OVD SET	0x5D	-	VOUTL1_OVD_SET[6:0]						R/W	0x40	

VOUTL1_OVD_SET[6:0] VOUTL1 OVD setting. Step: 2 mV default 0x40: 130 mV
 By setting this register as 0x00, VOUTL1 OVD function is disabled.

Table 38: VOUTL1 OVD Voltage

VOUTL1_OVD_SET[6:0]	OVD Voltage (mV)
0x00	Function Disable
0x01 to 0x0F	Clipped to 34
0x10	34
0x11	36
.....
.....
0x6D	220
0x6E to 0x7F	Clipped to 220

Register Name	Address	D7	D6	D5	D4	D3	D2	D1	D0	R/W	Default
VOUTL1 UVD SET	0x5E	-	VOUTL1_UVD_SET[6:0]						R/W	0x40	

VOUTL1_UVD_SET[6:0] VOUTL1 UVD setting. Step: 2 mV default 0x40: 130 mV
 By setting this register as 0x00, VOUTL1 UVD function is disabled.

Table 39: VOUTL1 UVD Voltage

VOUTL1_UVD_SET[6:0]	UVD Voltage (mV)
0x00	Function Disable
0x01 to 0x0F	Clipped to 34
0x10	34
0x11	36
.....
.....
0x6D	220
0x6E to 0x7F	Clipped to 220

5.2 Register Description – continued

5.2.14 VOUTS1 OCW SET

Register Name	Address	D7	D6	D5	D4	D3	D2	D1	D0	R/W	Default
VOUTS1 OCW SET	0x5F	-	-	VOUTS1_OCW_SET[5:0]						R/W	0x10/ 0x06

VOUTS1_OCW_SET[5:0] VOUTS1 OCW setting. Step: 50 mA (Internal Mode), 10 mV (External Mode)
 By setting this register as 0x00, VOUTS1 OCW function is disabled.
 Default value is determined by GATECNT (pin) condition.
 GATECNT (pin) = L: Default value is 0x10 (Internal: 800 mA).
 GATECNT (pin) = H: Default value is 0x06 (External: 70 mV).

Table 40: VOUTS1 OCW Current (Internal) and Voltage (External)

VOUTS1_OCW_SET[5:0]	Internal OCW Current (mA)	External OCW Voltage (mV)
0x00	Function Disable	Function Disable
0x01 to 0x03	Clipped to 200	Clipped to 50
0x04	200	50
0x05	250	60
0x06	300	70
.....
0x10	800	170
.....
0x18	1,200	250
0x19 to 0x3F	Clipped to 1,200	Clipped to 250

Internal OCW Current has $\pm 50\%$ of deviation.
 This is because it depends on Ron of internal SW.

5.2.15 VOUTS1 OCP SET

Register Name	Address	D7	D6	D5	D4	D3	D2	D1	D0	R/W	Default
VOUTS1 OCP SET	0x60	-	-	VOUTS1_OCP_SET[5:0]						R/W	0x16/ 0x08

VOUTS1_OCP_SET[5:0] VOUTS1 OCP setting. Step: 50 mA (Internal Mode), 10 mV (External Mode)
 By setting this register as 0x00, VOUTS1 OCP function is disabled.
 Default value is determined by GATECNT (pin) condition.
 GATECNT (pin) = L: Default value is 0x16 (Internal: 1,100 mA).
 GATECNT (pin) = H: Default value is 0x08 (External: 90 mV).

Table 41: VOUTS1 OCP Current (Internal) and Voltage (External)

VOUTS1_OCP_SET[5:0]	Internal OCP Current (mA)	External OCP Voltage (mV)
0x00	Function Disable	Function Disable
0x00 to 0x05	Clipped to 300	Clipped to 70
0x06	300	70
0x07	350	80
0x08	400	90
.....
0x16	1,100	230
.....
0x1B	1,350	280
0x1C to 0x3F	Clipped 1,350	Clipped to 280

Internal OCP Current has $\pm 50\%$ of deviation.
 This is because it depends on Ron of internal SW.

5.2 Register Description – continued

5.2.16 Dglitch Time

Register Name	Address	D7	D6	D5	D4	D3	D2	D1	D0	R/W	Default
Deglitch Time	0x61	-	UVD_OCW_DEG_TIM[2:0]			-	OVD_DEG_TIM[2:0]			R/W	0x33

OVD_DEG_TIM[2:0] Select OVD Deglitch Time

UVD_OCW_DEG_TIM[2:0] Select UVD and OCW Deglitch Time

0x0 : 0.5 μ s Deglitch Time
 0x1 : 25 μ s Deglitch Time
 0x2 : 50 μ s Deglitch Time
 0x3 : 75 μ s Deglitch Time
 0x4 to 0x7: 100 μ s Deglitch Time

(Note) Deglitch time is only time constructed in Logic. It is added 3 μ s (typ) the delay of the analog circuit part.

6. Typical Performance Curves

Unless otherwise specified: VIN = 3.3 V, Ta = 25 °C, IOUT = 0 A

6.1 Line Regulation

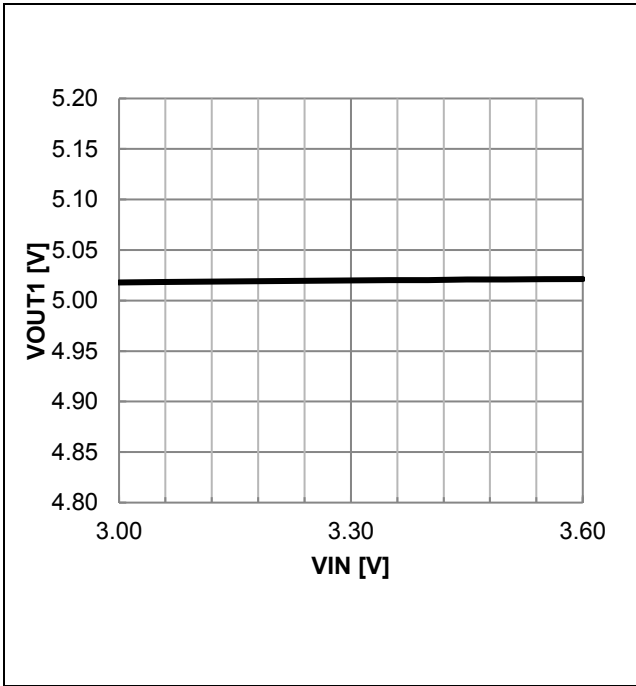

Figure 40. VOUT1 Output Voltage vs VIN

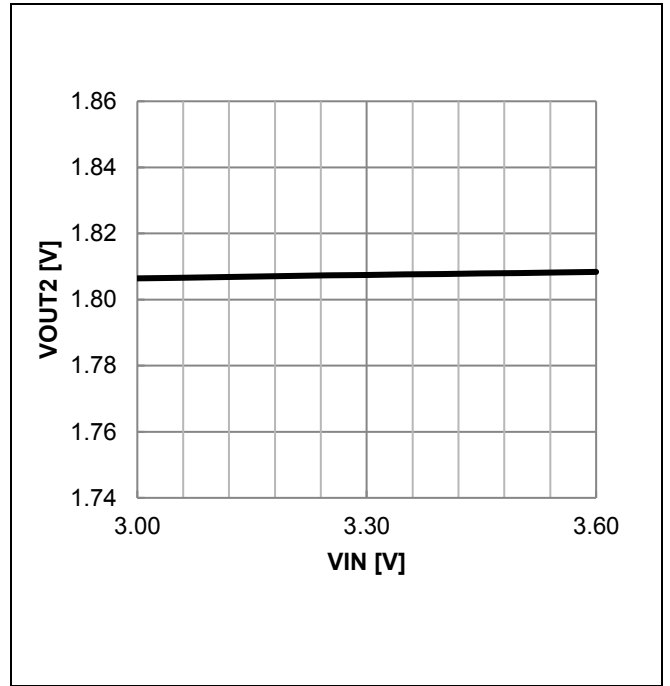

Figure 41. VOUT2 Output Voltage vs VIN

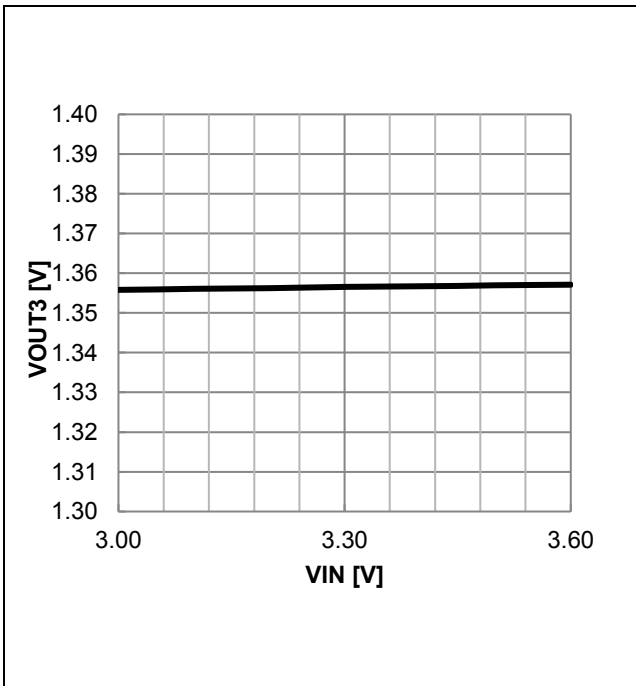

Figure 42. VOUT3 Output Voltage vs VIN (VOUT3 = 1.35 V Setting)

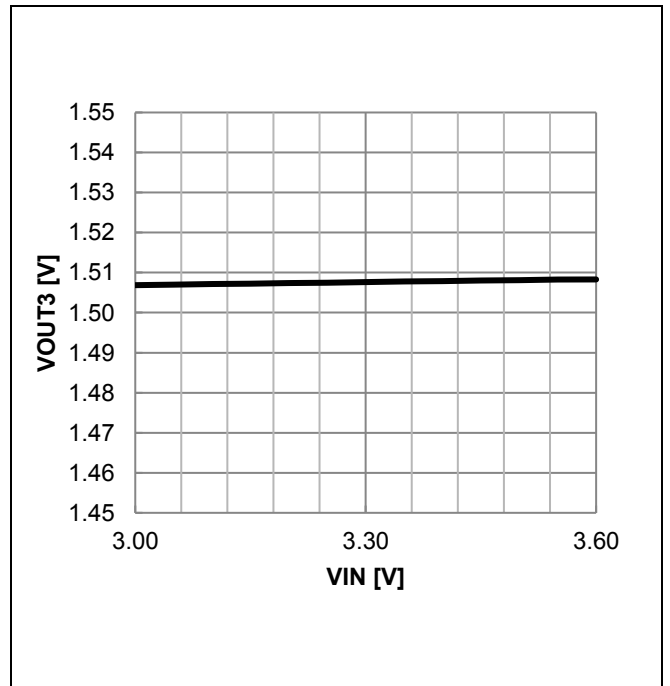

Figure 43. VOUT3 Output Voltage vs VIN (VOUT3 = 1.5 V Setting)

6.1 Line Regulation - continued

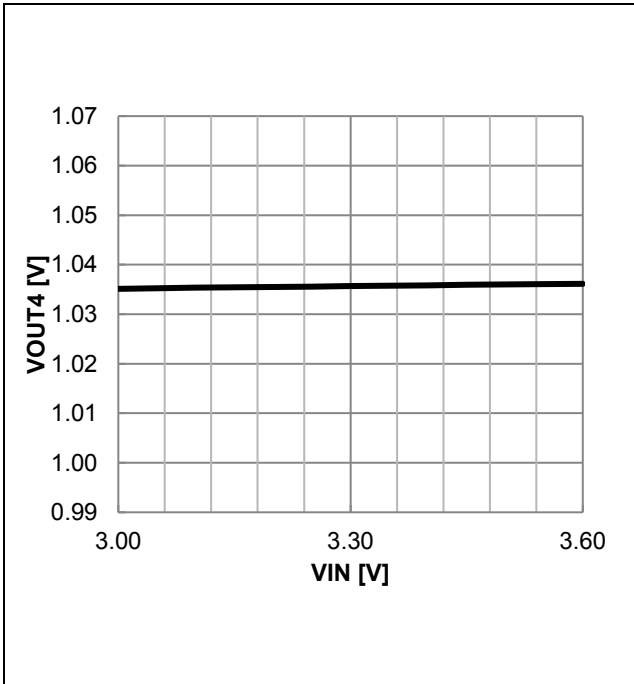

Figure 44. VOUT4 Output Voltage vs VIN

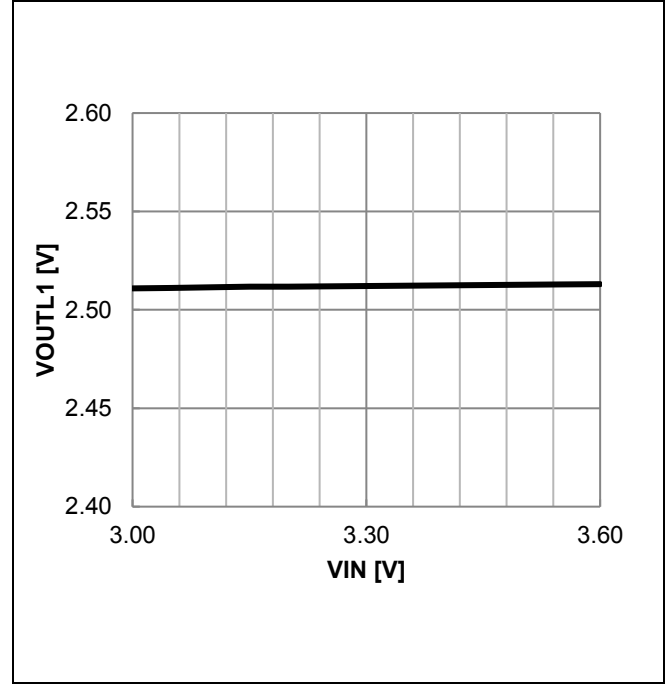

Figure 45. VOUTL1 Output Voltage vs VIN

6. Typical Performance Curves – continued

6.2 Load Regulation

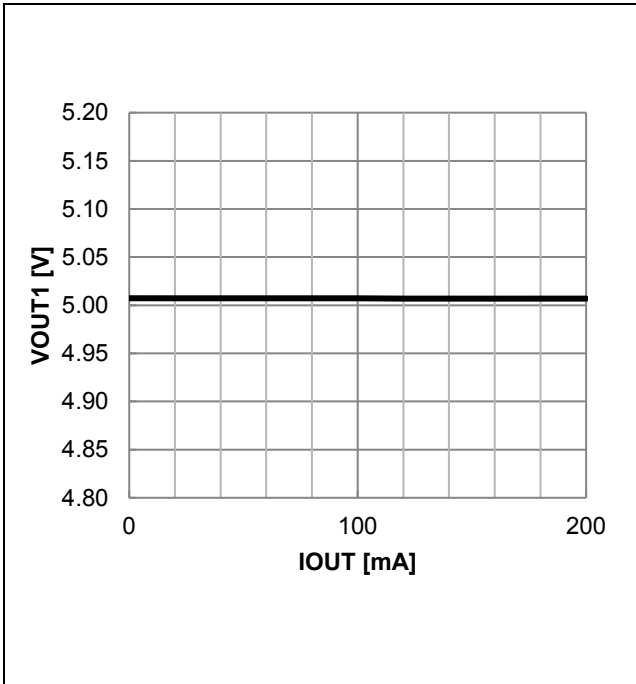

Figure 46. VOUT1 Output Voltage vs IOUT

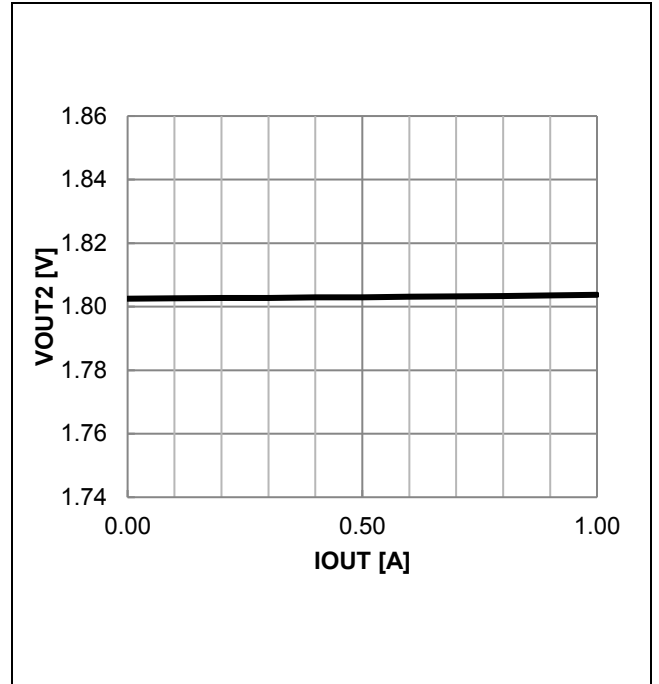

Figure 47. VOUT2 Output Voltage vs IOUT

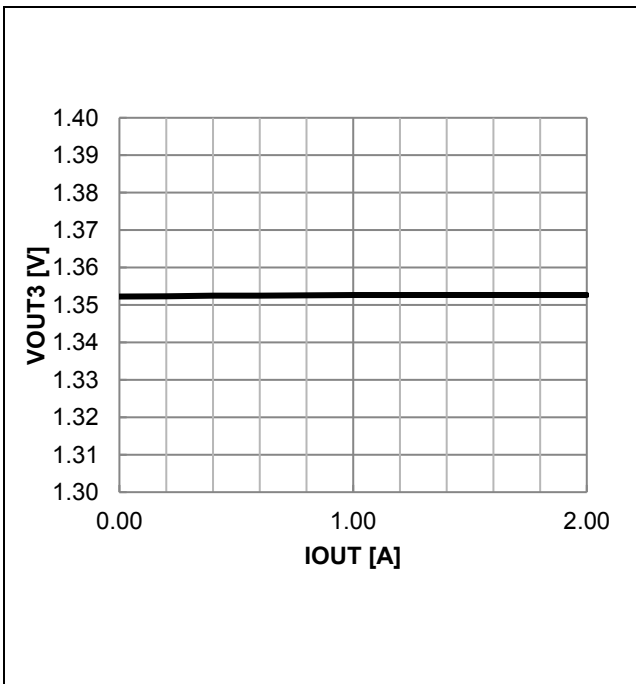

Figure 48. VOUT3 Output Voltage vs IOUT
(VOUT3 = 1.35 V Setting)

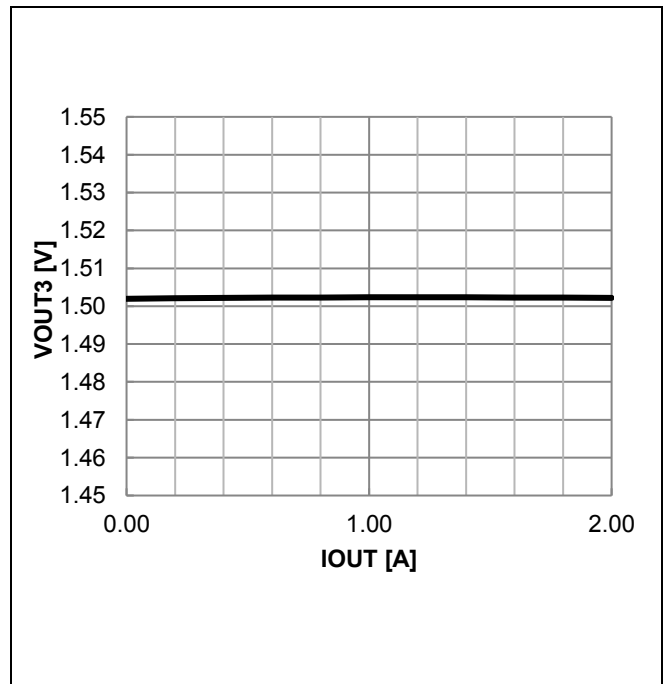

Figure 49. VOUT3 Output Voltage vs IOUT
(VOUT3 = 1.5 V Setting)

6.2 Load Regulation - continued

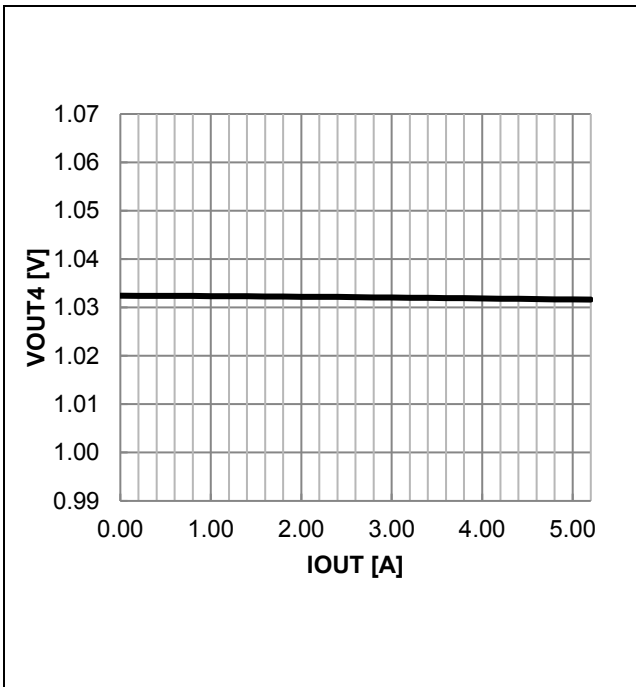

Figure 50. VOUT4 Output Voltage vs IOU

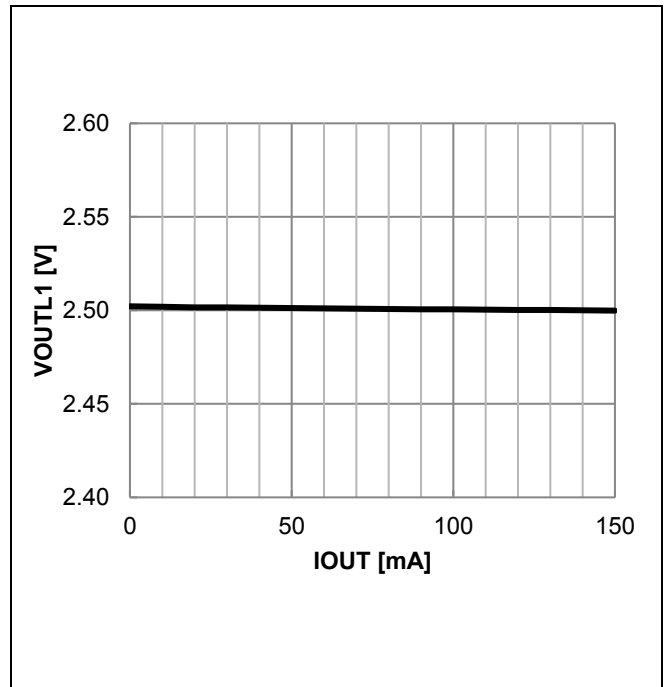

Figure 51. VOUTL1 Output Voltage vs IOU

6. Typical Performance Curves – continued

6.3 Power Efficiency

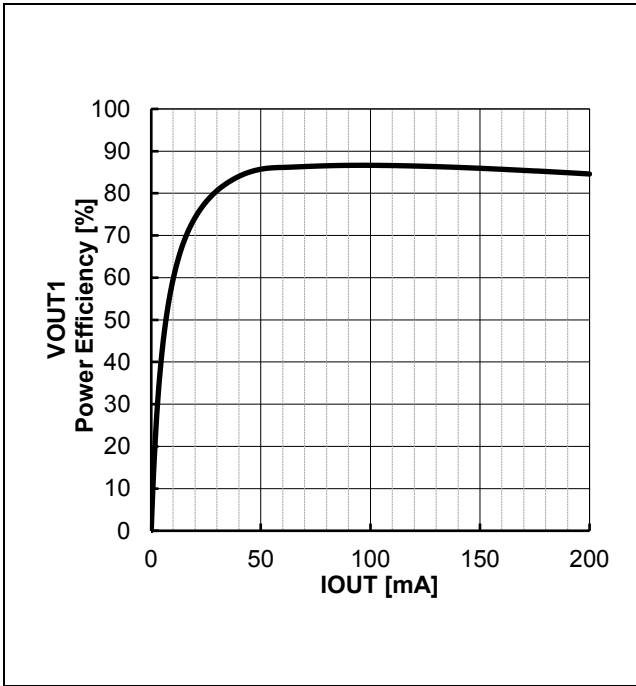

Figure 52. VOUT1 Power Efficiency vs IOU1

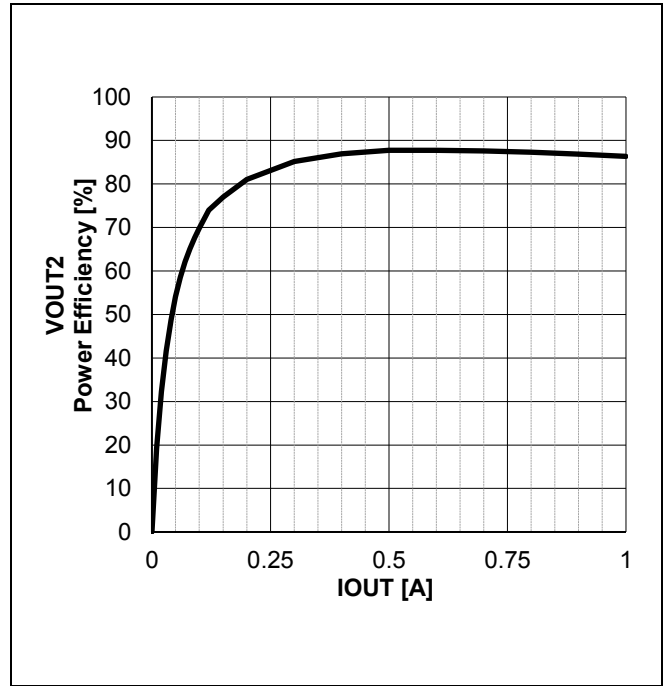

Figure 53. VOUT2 Power Efficiency vs IOU2

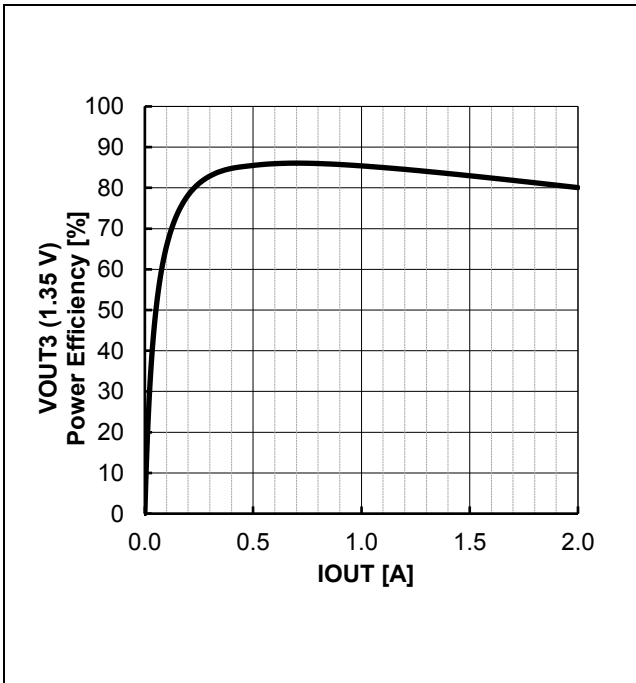

Figure 54. VOUT3 Power Efficiency vs IOU3 (VOUT3 = 1.35 V Setting)

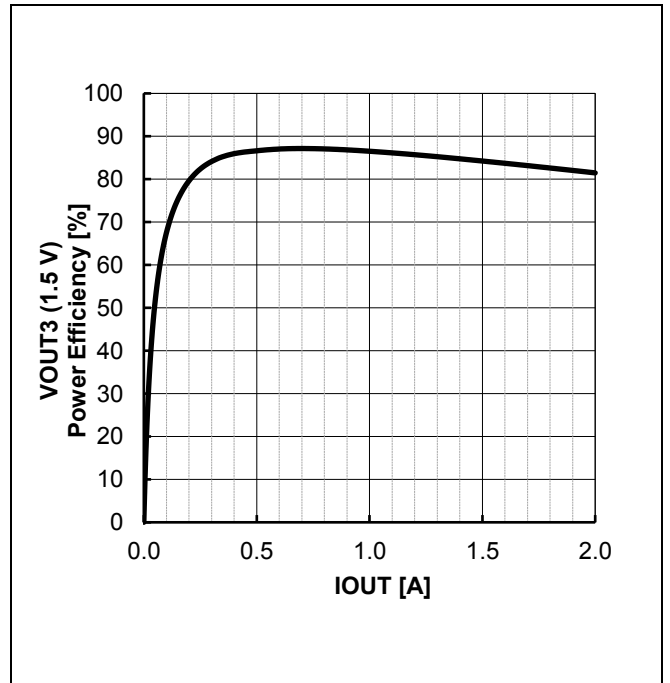

Figure 55. VOUT3 Power Efficiency vs IOU3 (VOUT3 = 1.5 V Setting)

6.3 Power Efficiency - continued

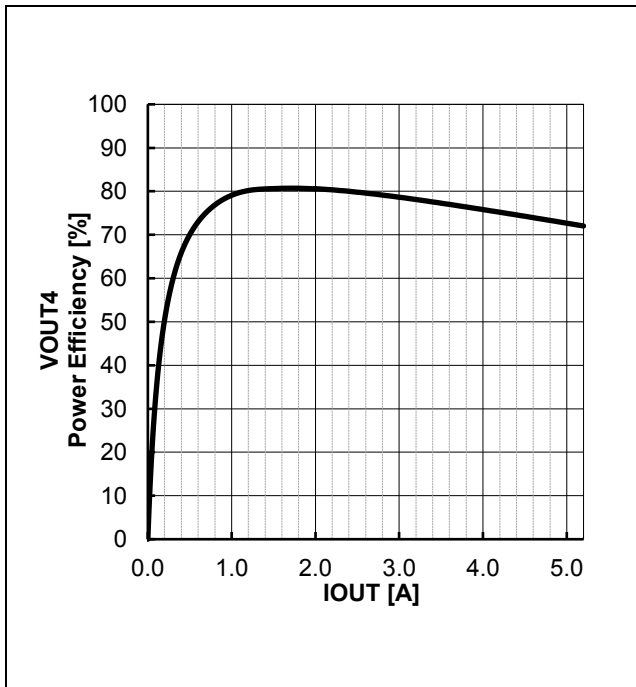

Figure 56. VOUT4 Power Efficiency vs IOUT

6. Typical Performance Curves – continued

6.4 Power ON Waveform

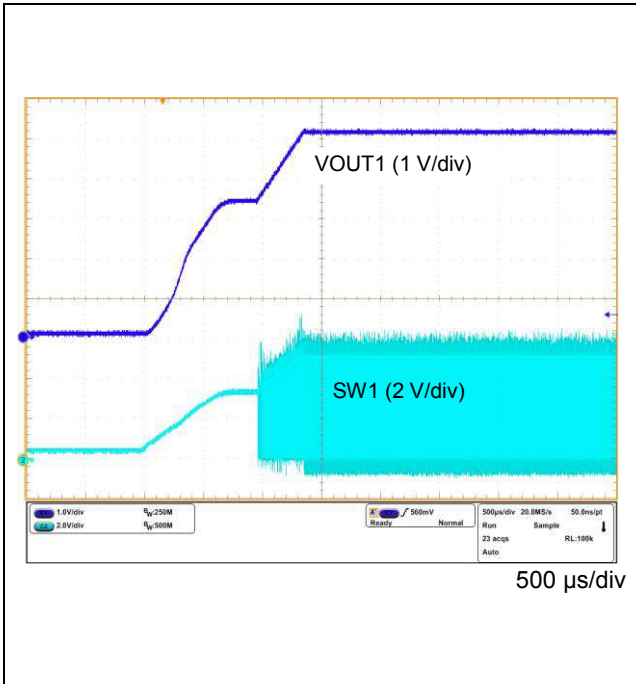

Figure 57. VOUT1 Power ON Waveform

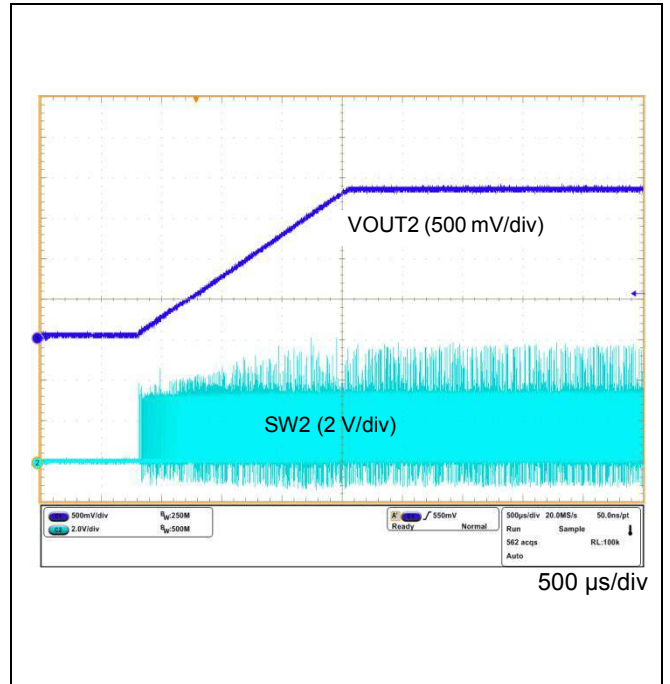

Figure 58. VOUT2 Power ON Waveform

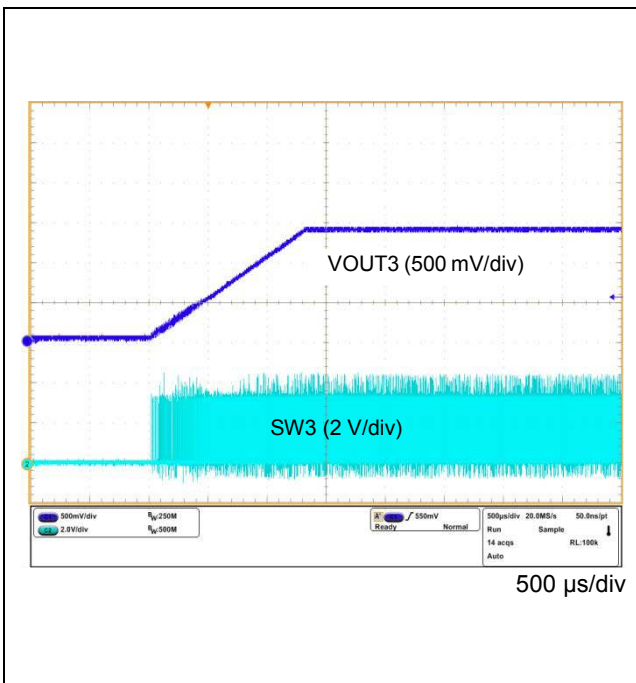

Figure 59. VOUT3 Power ON Waveform (VOUT3 = 1.35 V Setting)

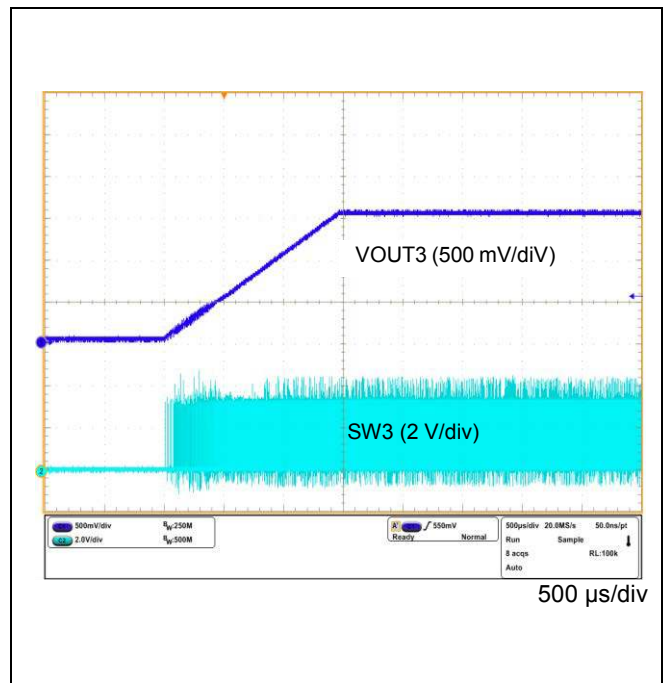

Figure 60. VOUT3 Power ON Waveform (VOUT3 = 1.5 V Setting)

6.4 Power ON Waveform - continued

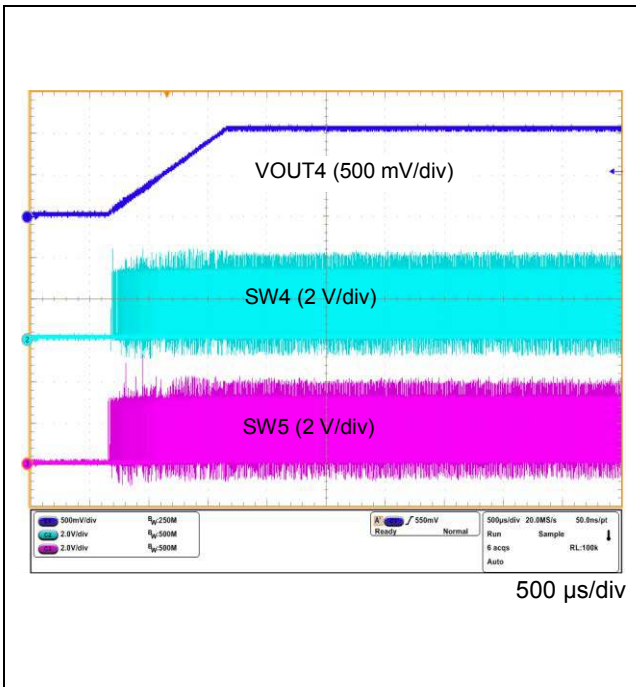

Figure 61. VOUT4 Power ON Waveform

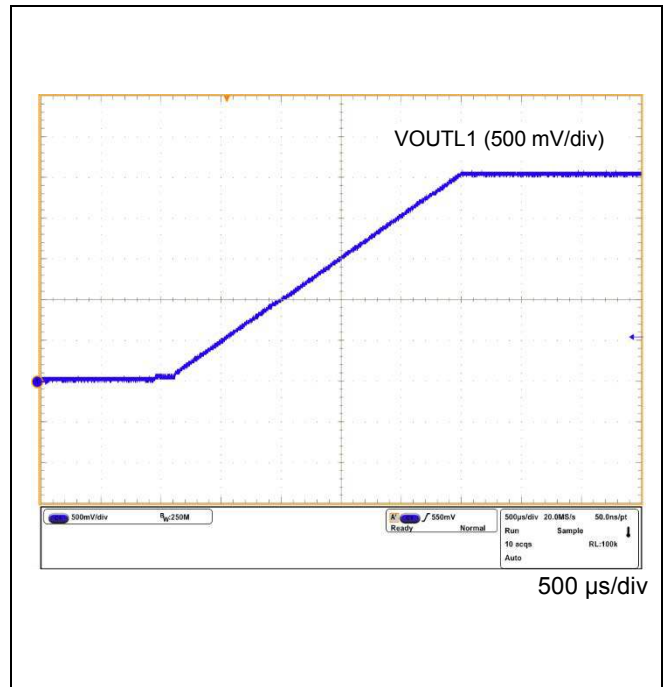

Figure 62. VOUTL1 Power ON Waveform

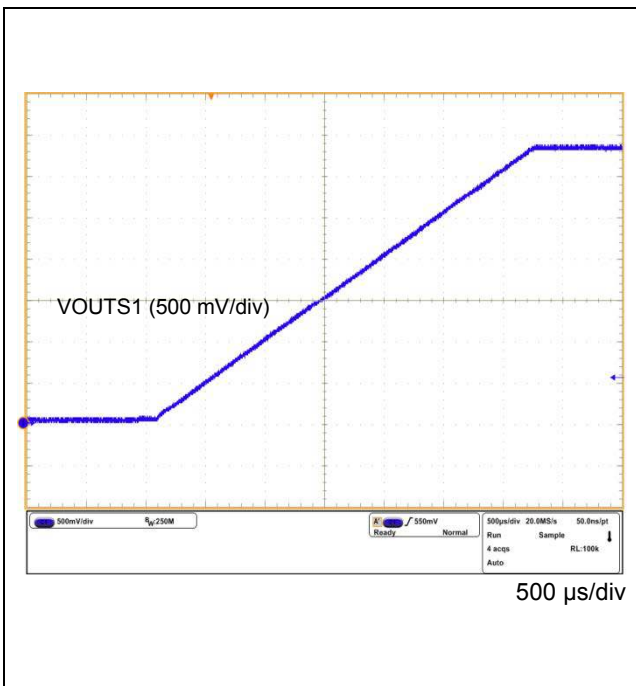

Figure 63. VOUTS1 Power ON Waveform

6. Typical Performance Curves – continued

6.5 Power OFF Waveform

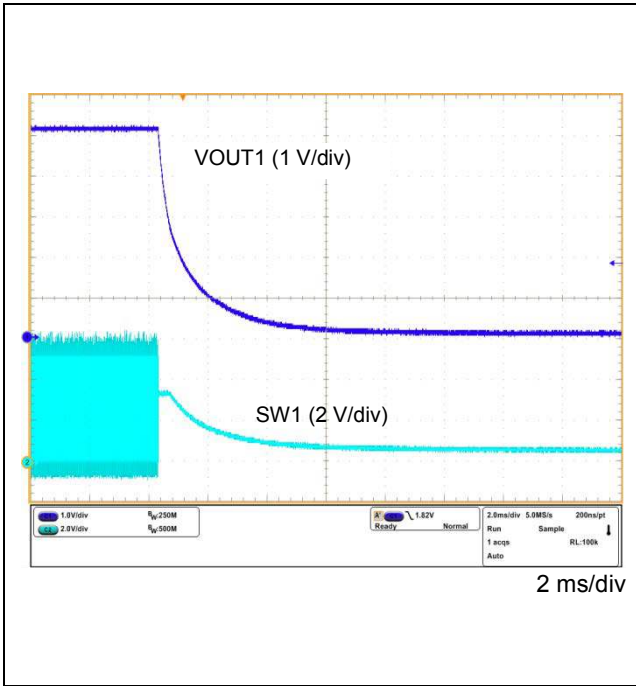

Figure 64. VOUT1 Power OFF Waveform

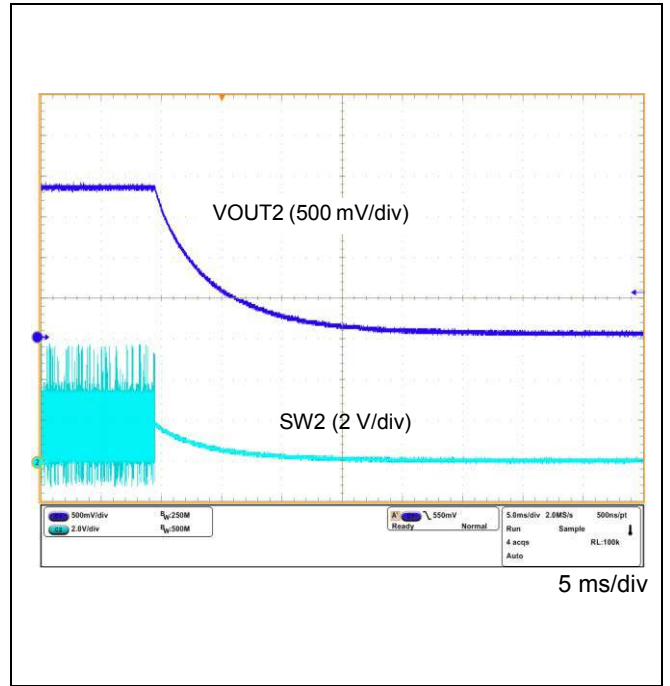

Figure 65. VOUT2 Power OFF Waveform

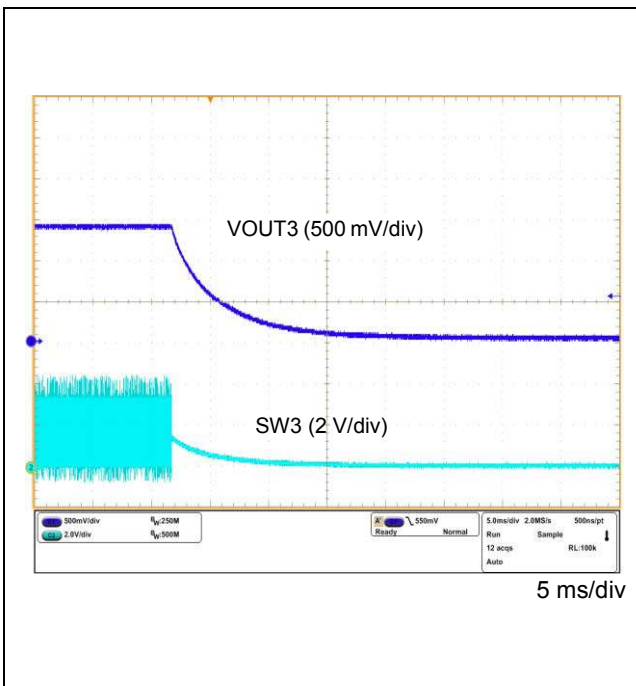

Figure 66. VOUT3 Power OFF Waveform (VOUT3 = 1.35 V Setting)

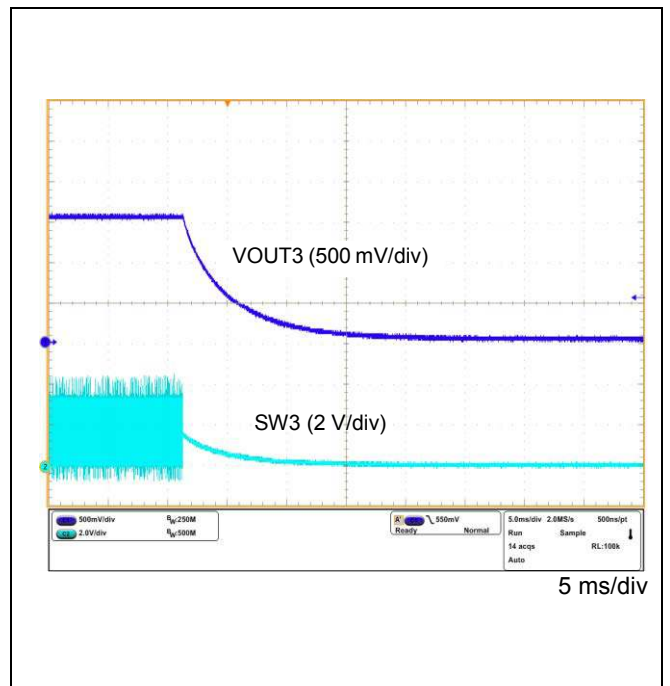

Figure 67. VOUT3 Power OFF Waveform (VOUT3 = 1.5 V Setting)

6.5 Power OFF Waveform - continued

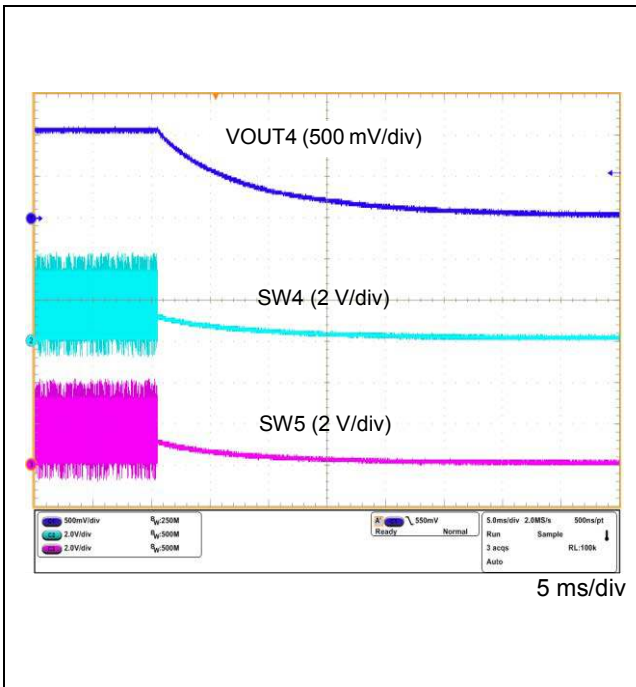

Figure 68. VOUT4 Power OFF Waveform

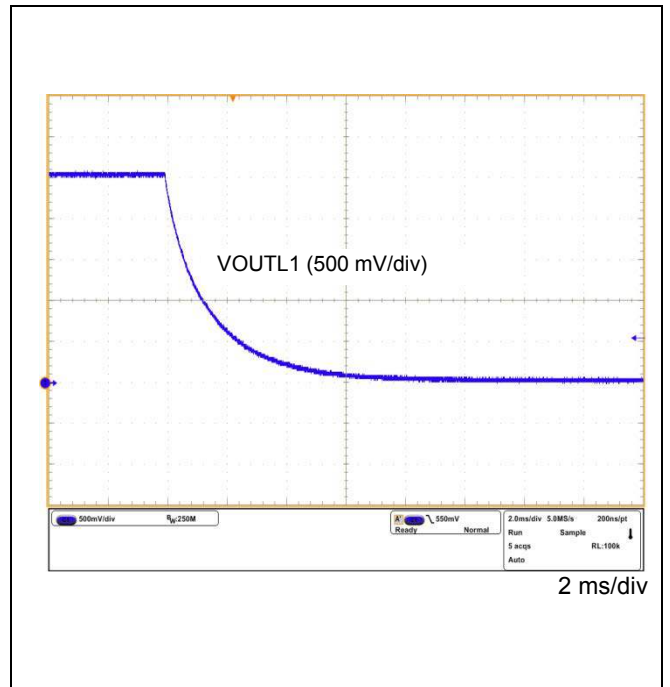

Figure 69. VOUTL1 Power OFF Waveform

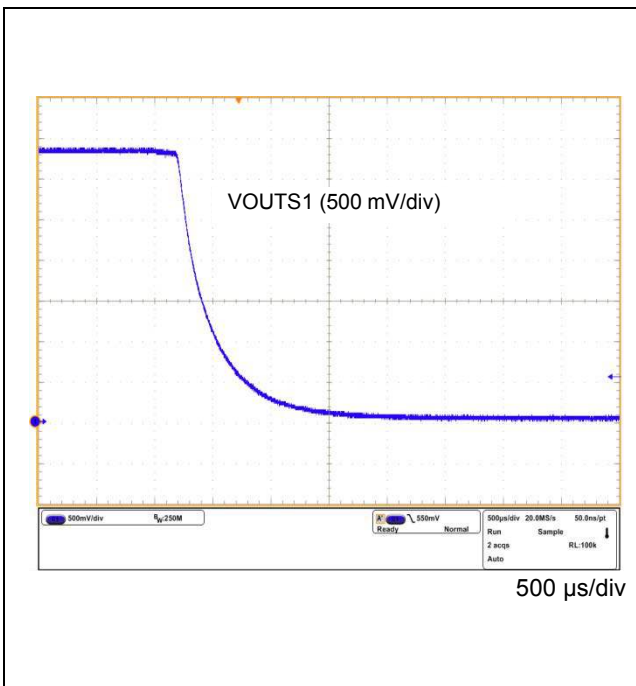

Figure 70. VOUTS1 Power OFF Waveform

6. Typical Performance Curves – continued

6.6 Load Transient

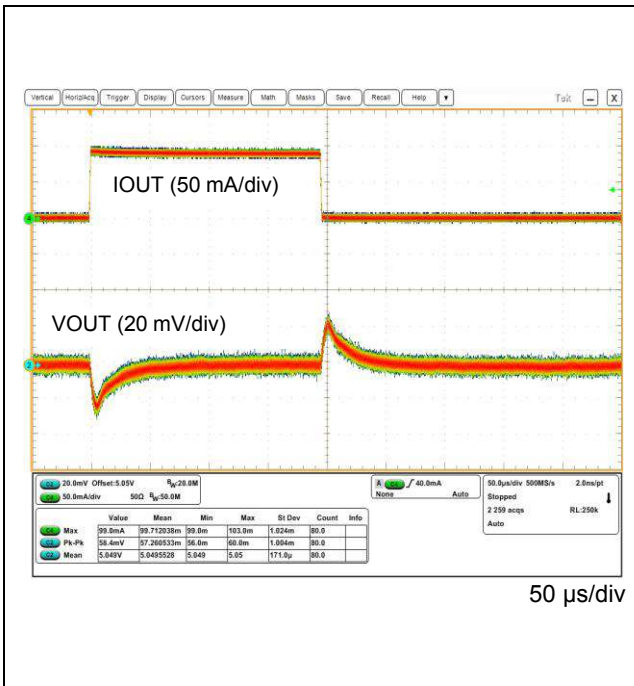

Figure 71. VOUT1 Load Transient (IOUT = 0 A to 100 mA (SR = 100 mA/μs))

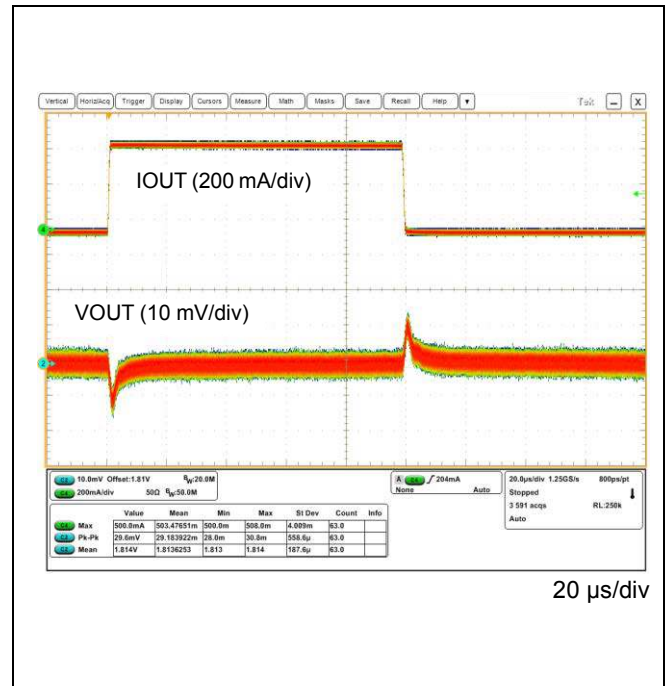

Figure 72. VOUT2 Load Transient (IOUT = 0 A to 0.5 A (SR = 1 A/μs))

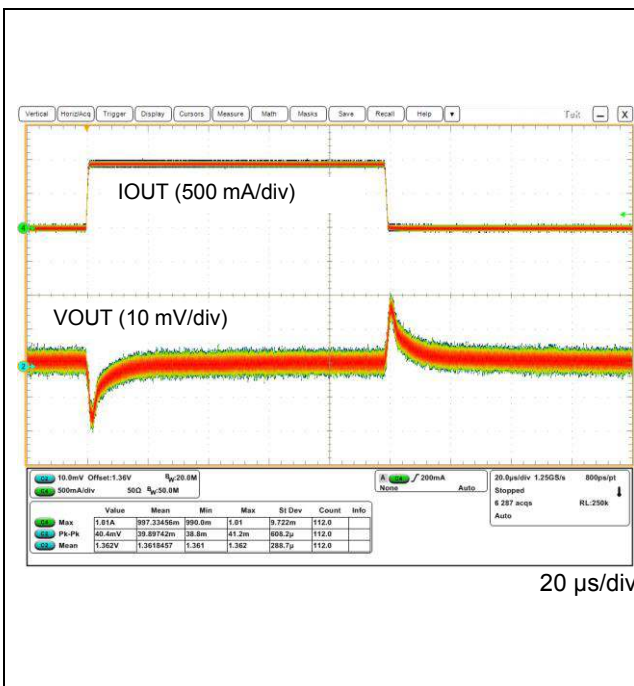

Figure 73. VOUT3 Load Transient (VOUT3 = 1.35 V Setting, IOUT = 0 A to 1 A (SR = 1 A/μs))

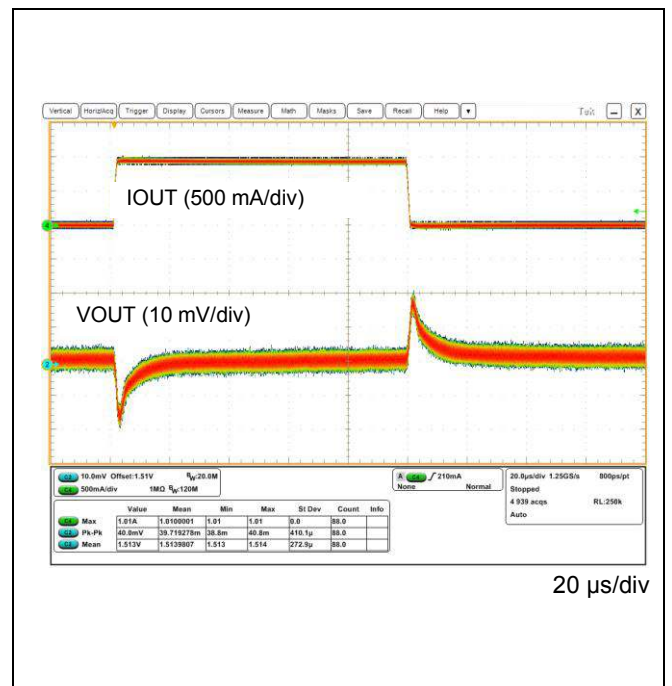

Figure 74. VOUT3 Load Transient (VOUT3 = 1.5 V Setting, IOUT = 0 A to 1 A (SR = 1 A/μs))

6.6 Load Transient- continued

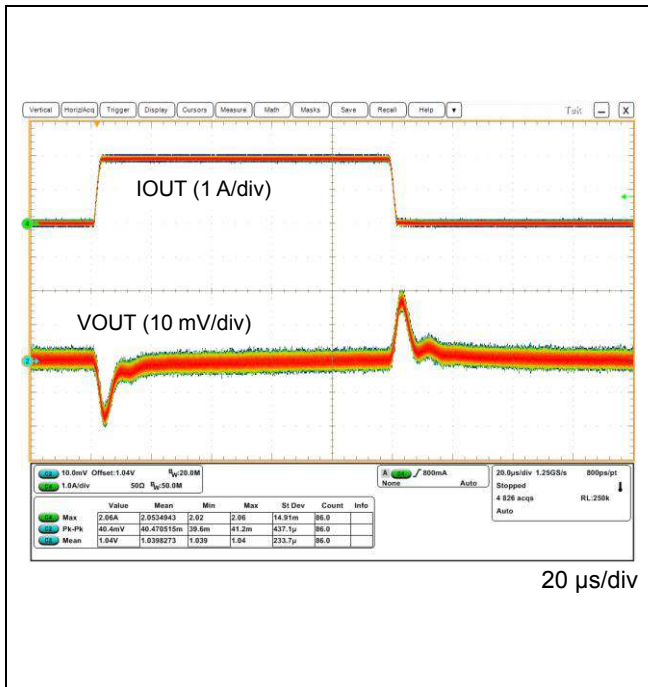

Figure 75. VOUT4 Load Transient (IOUT = 0 A to 2.05 A (SR = 1 A/μs))

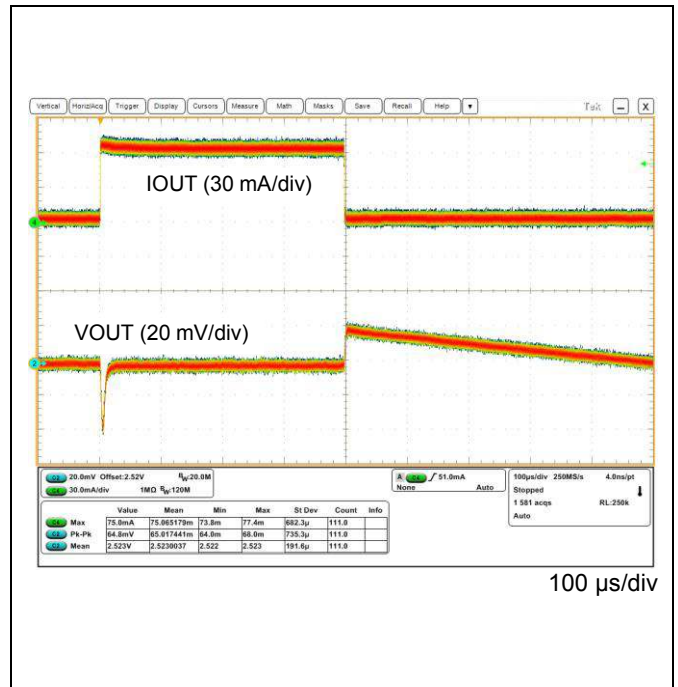

Figure 76. VOUTL1 Load Transient (IOUT = 0 A to 75 mA (SR = 100 mA/μs))

7. Operational Notes

1. Reverse Connection of Power Supply

Connecting the power supply in reverse polarity can damage the IC. Take precautions against reverse polarity when connecting the power supply, such as mounting an external diode between the power supply and the IC's power supply pins.

2. Power Supply Lines

Design the PCB layout pattern to provide low impedance supply lines. Separate the ground and supply lines of the digital and analog blocks to prevent noise in the ground and supply lines of the digital block from affecting the analog block. Furthermore, connect a capacitor to ground at all power supply pins. Consider the effect of temperature and aging on the capacitance value when using electrolytic capacitors.

3. Ground Voltage

Ensure that no pins are at a voltage below that of the ground pin at any time, even during transient condition. However, pins that drive inductive loads (e.g. motor driver outputs, DC-DC converter outputs) may inevitably go below ground due to back EMF or electromotive force. In such cases, the user should make sure that such voltages going below ground will not cause the IC and the system to malfunction by examining carefully all relevant factors and conditions such as motor characteristics, supply voltage, operating frequency and PCB wiring to name a few.

4. Ground Wiring Pattern

When using both small-signal and large-current ground traces, the two ground traces should be routed separately but connected to a single ground at the reference point of the application board to avoid fluctuations in the small-signal ground caused by large currents. Also ensure that the ground traces of external components do not cause variations on the ground voltage. The ground lines must be as short and thick as possible to reduce line impedance.

5. Recommended Operating Conditions

The function and operation of the IC are guaranteed within the range specified by the recommended operating conditions. The characteristic values are guaranteed only under the conditions of each item specified by the electrical characteristics.

6. Inrush Current

When power is first supplied to the IC, it is possible that the internal logic may be unstable and inrush current may flow instantaneously due to the internal powering sequence and delays, especially if the IC has more than one power supply. Therefore, give special consideration to power coupling capacitance, power wiring, width of ground wiring, and routing of connections.

7. Testing on Application Boards

When testing the IC on an application board, connecting a capacitor directly to a low-impedance output pin may subject the IC to stress. Always discharge capacitors completely after each process or step. The IC's power supply should always be turned off completely before connecting or removing it from the test setup during the inspection process. To prevent damage from static discharge, ground the IC during assembly and use similar precautions during transport and storage.

7. Operational Notes – continued

8. Inter-pin Short and Mounting Errors

Ensure that the direction and position are correct when mounting the IC on the PCB. Incorrect mounting may result in damaging the IC. Avoid nearby pins being shorted to each other especially to ground, power supply and output pin. Inter-pin shorts could be due to many reasons such as metal particles, water droplets (in very humid environment) and unintentional solder bridge deposited in between pins during assembly to name a few.

9. Unused Input Pins

Input pins of an IC are often connected to the gate of a MOS transistor. The gate has extremely high impedance and extremely low capacitance. If left unconnected, the electric field from the outside can easily charge it. The small charge acquired in this way is enough to produce a significant effect on the conduction through the transistor and cause unexpected operation of the IC. So unless otherwise specified, unused input pins should be connected to the power supply or ground line.

10. Regarding the Input Pin of the IC

This monolithic IC contains P+ isolation and P substrate layers between adjacent elements in order to keep them isolated. P-N junctions are formed at the intersection of the P layers with the N layers of other elements, creating a parasitic diode or transistor. For example (refer to figure below):

When $GND > Pin A$ and $GND > Pin B$, the P-N junction operates as a parasitic diode.

When $GND > Pin B$, the P-N junction operates as a parasitic transistor.

Parasitic diodes inevitably occur in the structure of the IC. The operation of parasitic diodes can result in mutual interference among circuits, operational faults, or physical damage. Therefore, conditions that cause these diodes to operate, such as applying a voltage lower than the GND voltage to an input pin (and thus to the P substrate) should be avoided.

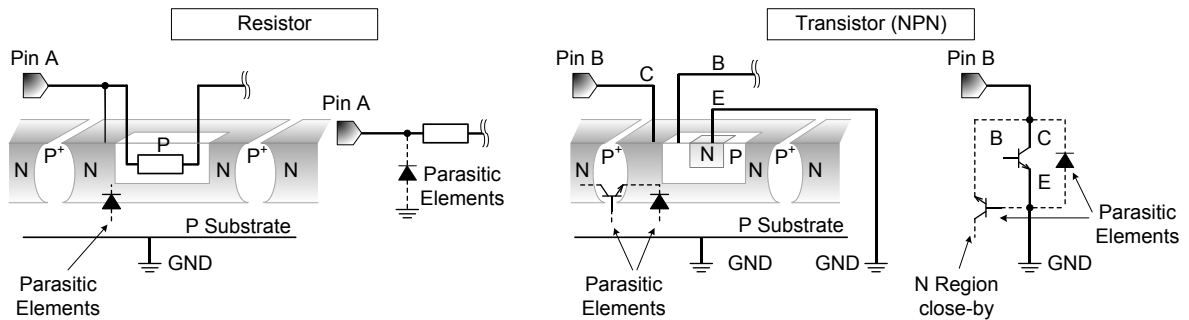

Figure 77. Example of Monolithic IC Structure

7. Operational Notes – continued

11. Ceramic Capacitor

When using a ceramic capacitor, determine a capacitance value considering the change of capacitance with temperature and the decrease in nominal capacitance due to DC bias and others.

12. Thermal Shutdown Circuit (TSD)

This IC has a built-in thermal shutdown circuit that prevents heat damage to the IC. Normal operation should always be within the IC's maximum junction temperature rating. If however the rating is exceeded for a continued period, the junction temperature (T_j) will rise which will activate the TSD circuit that will turn OFF power output pins. The IC should be powered down and turned ON again to resume normal operation because the TSD circuit keeps the outputs at the OFF state even if the T_j falls below the TSD threshold.

Note that the TSD circuit operates in a situation that exceeds the absolute maximum ratings and therefore, under no circumstances, should the TSD circuit be used in a set design or for any purpose other than protecting the IC from heat damage.

13. Over Current Protection Circuit (OCP)

This IC incorporates an integrated overcurrent protection circuit that is activated when the load is shorted. This protection circuit is effective in preventing damage due to sudden and unexpected incidents. However, the IC should not be used in applications characterized by continuous operation or transitioning of the protection circuit.

14. Functional Safety

"ISO 26262 process compliant to support ASIL-*"

A product that has been developed based on an ISO 26262 design process compliant to the ASIL level described in the datasheet.

"Safety mechanism is implemented to support functional safety (ASIL-*)"

A product that has implemented safety mechanism to meet ASIL level requirements described in the datasheet.

"Functional safety supportive automotive products"

A product that has been developed for automotive use and is capable of supporting safety analysis with regard to the functional safety.

(Note) "ASIL-*" stands for the ratings of "ASIL-A", "-B", "-C" or "-D" specified by each product's datasheet.

8. Revision History

Date	Revision	Changes
02.Oct.2020	001	New Release

Notice

Precaution on using ROHM Products

1. If you intend to use our Products in devices requiring extremely high reliability (such as medical equipment ^(Note 1), aircraft/spacecraft, nuclear power controllers, etc.) and whose malfunction or failure may cause loss of human life, bodily injury or serious damage to property ("Specific Applications"), please consult with the ROHM sales representative in advance. Unless otherwise agreed in writing by ROHM in advance, ROHM shall not be in any way responsible or liable for any damages, expenses or losses incurred by you or third parties arising from the use of any ROHM's Products for Specific Applications.

(Note1) Medical Equipment Classification of the Specific Applications

JAPAN	USA	EU	CHINA
CLASS III	CLASS III	CLASS II b	CLASS III
CLASS IV		CLASS III	

2. ROHM designs and manufactures its Products subject to strict quality control system. However, semiconductor products can fail or malfunction at a certain rate. Please be sure to implement, at your own responsibilities, adequate safety measures including but not limited to fail-safe design against the physical injury, damage to any property, which a failure or malfunction of our Products may cause. The following are examples of safety measures:
 - [a] Installation of protection circuits or other protective devices to improve system safety
 - [b] Installation of redundant circuits to reduce the impact of single or multiple circuit failure
3. Our Products are not designed under any special or extraordinary environments or conditions, as exemplified below. Accordingly, ROHM shall not be in any way responsible or liable for any damages, expenses or losses arising from the use of any ROHM's Products under any special or extraordinary environments or conditions. If you intend to use our Products under any special or extraordinary environments or conditions (as exemplified below), your independent verification and confirmation of product performance, reliability, etc. prior to use, must be necessary:
 - [a] Use of our Products in any types of liquid, including water, oils, chemicals, and organic solvents
 - [b] Use of our Products outdoors or in places where the Products are exposed to direct sunlight or dust
 - [c] Use of our Products in places where the Products are exposed to sea wind or corrosive gases, including Cl₂, H₂S, NH₃, SO₂, and NO₂
 - [d] Use of our Products in places where the Products are exposed to static electricity or electromagnetic waves
 - [e] Use of our Products in proximity to heat-producing components, plastic cords, or other flammable items
 - [f] Sealing or coating our Products with resin or other coating materials
 - [g] Use of our Products without cleaning residue of flux (Exclude cases where no-clean type fluxes is used. However, recommend sufficiently about the residue.); or Washing our Products by using water or water-soluble cleaning agents for cleaning residue after soldering
 - [h] Use of the Products in places subject to dew condensation
4. The Products are not subject to radiation-proof design.
5. Please verify and confirm characteristics of the final or mounted products in using the Products.
6. In particular, if a transient load (a large amount of load applied in a short period of time, such as pulse, is applied, confirmation of performance characteristics after on-board mounting is strongly recommended. Avoid applying power exceeding normal rated power; exceeding the power rating under steady-state loading condition may negatively affect product performance and reliability.
7. De-rate Power Dissipation depending on ambient temperature. When used in sealed area, confirm that it is the use in the range that does not exceed the maximum junction temperature.
8. Confirm that operation temperature is within the specified range described in the product specification.
9. ROHM shall not be in any way responsible or liable for failure induced under deviant condition from what is defined in this document.

Precaution for Mounting / Circuit board design

1. When a highly active halogenous (chlorine, bromine, etc.) flux is used, the residue of flux may negatively affect product performance and reliability.
2. In principle, the reflow soldering method must be used on a surface-mount products, the flow soldering method must be used on a through hole mount products. If the flow soldering method is preferred on a surface-mount products, please consult with the ROHM representative in advance.

For details, please refer to ROHM Mounting specification

Precautions Regarding Application Examples and External Circuits

1. If change is made to the constant of an external circuit, please allow a sufficient margin considering variations of the characteristics of the Products and external components, including transient characteristics, as well as static characteristics.
2. You agree that application notes, reference designs, and associated data and information contained in this document are presented only as guidance for Products use. Therefore, in case you use such information, you are solely responsible for it and you must exercise your own independent verification and judgment in the use of such information contained in this document. ROHM shall not be in any way responsible or liable for any damages, expenses or losses incurred by you or third parties arising from the use of such information.

Precaution for Electrostatic

This Product is electrostatic sensitive product, which may be damaged due to electrostatic discharge. Please take proper caution in your manufacturing process and storage so that voltage exceeding the Products maximum rating will not be applied to Products. Please take special care under dry condition (e.g. Grounding of human body / equipment / solder iron, isolation from charged objects, setting of ionizer, friction prevention and temperature / humidity control).

Precaution for Storage / Transportation

1. Product performance and soldered connections may deteriorate if the Products are stored in the places where:
 - [a] the Products are exposed to sea winds or corrosive gases, including Cl₂, H₂S, NH₃, SO₂, and NO₂
 - [b] the temperature or humidity exceeds those recommended by ROHM
 - [c] the Products are exposed to direct sunshine or condensation
 - [d] the Products are exposed to high Electrostatic
2. Even under ROHM recommended storage condition, solderability of products out of recommended storage time period may be degraded. It is strongly recommended to confirm solderability before using Products of which storage time is exceeding the recommended storage time period.
3. Store / transport cartons in the correct direction, which is indicated on a carton with a symbol. Otherwise bent leads may occur due to excessive stress applied when dropping of a carton.
4. Use Products within the specified time after opening a humidity barrier bag. Baking is required before using Products of which storage time is exceeding the recommended storage time period.

Precaution for Product Label

A two-dimensional barcode printed on ROHM Products label is for ROHM's internal use only.

Precaution for Disposition

When disposing Products please dispose them properly using an authorized industry waste company.

Precaution for Foreign Exchange and Foreign Trade act

Since concerned goods might be fallen under listed items of export control prescribed by Foreign exchange and Foreign trade act, please consult with ROHM in case of export.

Precaution Regarding Intellectual Property Rights

1. All information and data including but not limited to application example contained in this document is for reference only. ROHM does not warrant that foregoing information or data will not infringe any intellectual property rights or any other rights of any third party regarding such information or data.
2. ROHM shall not have any obligations where the claims, actions or demands arising from the combination of the Products with other articles such as components, circuits, systems or external equipment (including software).
3. No license, expressly or implied, is granted hereby under any intellectual property rights or other rights of ROHM or any third parties with respect to the Products or the information contained in this document. Provided, however, that ROHM will not assert its intellectual property rights or other rights against you or your customers to the extent necessary to manufacture or sell products containing the Products, subject to the terms and conditions herein.

Other Precaution

1. This document may not be reprinted or reproduced, in whole or in part, without prior written consent of ROHM.
2. The Products may not be disassembled, converted, modified, reproduced or otherwise changed without prior written consent of ROHM.
3. In no event shall you use in any way whatsoever the Products and the related technical information contained in the Products or this document for any military purposes, including but not limited to, the development of mass-destruction weapons.
4. The proper names of companies or products described in this document are trademarks or registered trademarks of ROHM, its affiliated companies or third parties.

General Precaution

1. Before you use our Products, you are requested to carefully read this document and fully understand its contents. ROHM shall not be in any way responsible or liable for failure, malfunction or accident arising from the use of any ROHM's Products against warning, caution or note contained in this document.
2. All information contained in this document is current as of the issuing date and subject to change without any prior notice. Before purchasing or using ROHM's Products, please confirm the latest information with a ROHM sales representative.
3. The information contained in this document is provided on an "as is" basis and ROHM does not warrant that all information contained in this document is accurate and/or error-free. ROHM shall not be in any way responsible or liable for any damages, expenses or losses incurred by you or third parties resulting from inaccuracy or errors of or concerning such information.