

PP 2,5/ 1-M - Plug

3211274

<https://www.phoenixcontact.com/pc/products/3211274>



Please be informed that the data shown in this PDF document is generated from our online catalog. Please find the complete data in the user documentation. Our general terms of use for downloads are valid.



Plug, center element, nom. voltage: 800 V, nominal current: 24 A, number of connections: 1, number of positions: 1, connection method: Push-in connection, 1 level, Rated cross section: 2.5 mm², cross section: 0.14 mm² - 4 mm², color: gray

Your advantages

- The Push-in technology COMBI plugs for self-assembly provide solutions that users can implement themselves

Commercial data

Item number	3211274
Packing unit	50 pc
Minimum order quantity	50 pc
Product key	BE2244
Catalog page	Page 301 (C-1-2019)
GTIN	4055626285276
Weight per piece (including packing)	3.65 g
Weight per piece (excluding packing)	3.65 g
Customs tariff number	85366990
Country of origin	PL

PP 2,5/ 1-M - Plug

3211274

<https://www.phoenixcontact.com/pc/products/3211274>

Technical data

Product properties

Product type	Terminal plug
Number of positions	1
Pitch	5.2 mm
Area of application	Machine building Plant engineering
Number of connections	1
Number of rows	1
Potentials	1

Insulation characteristics

Overvoltage category	III
Degree of pollution	3

Electrical properties

Rated surge voltage	6 kV
Maximum power dissipation for nominal condition	0.77 W

Connection data

Number of connections per level	1
Nominal cross section	2.5 mm ²

1 level

Stripping length	8 mm ... 10 mm
Internal cylindrical gage	A3
Connection in acc. with standard	IEC 61984
Conductor cross section rigid	0.14 mm ² ... 4 mm ²
Cross section AWG	26 ... 12 (converted acc. to IEC)
Conductor cross section flexible	0.14 mm ² ... 2.5 mm ²
Conductor cross section, flexible [AWG]	26 ... 14 (converted acc. to IEC)
Conductor cross-section flexible (ferrule without plastic sleeve)	0.14 mm ² ... 2.5 mm ²
Flexible conductor cross section (ferrule with plastic sleeve)	0.14 mm ² ... 2.5 mm ²
2 conductors with the same cross section, flexible, with TWIN ferrule with plastic sleeve	0.5 mm ²
Nominal current	24 A
Maximum load current	24 A (with 4 mm ² conductor cross section)
Nominal voltage	800 V
Nominal cross section	2.5 mm ²

1 level Connection cross sections directly pluggable

Conductor cross section rigid	0.34 mm ² ... 4 mm ²
Conductor cross-section flexible (ferrule without plastic sleeve)	0.34 mm ² ... 2.5 mm ²
Flexible conductor cross section (ferrule with plastic sleeve)	0.34 mm ² ... 2.5 mm ²

PP 2,5/ 1-M - Plug



3211274

<https://www.phoenixcontact.com/pc/products/3211274>

Dimensions

Width	5.2 mm
Height	16 mm
Depth	41.2 mm
Pitch	5.2 mm

Material specifications

Color	gray
Flammability rating according to UL 94	V0
Insulating material group	I
Insulating material	PA

Mechanical properties

Mechanical data

Open side panel	No
-----------------	----

Environmental and real-life conditions

Ambient conditions

Ambient temperature (operation)	-60 °C ... 105 °C (max. short-term operating temperature RTI Elec.)
Ambient temperature (storage/transport)	-25 °C ... 60 °C (for a short time, not exceeding 24 h, -60 °C to +70 °C)
Ambient temperature (assembly)	-5 °C ... 70 °C
Ambient temperature (actuation)	-5 °C ... 70 °C
Permissible humidity (storage/transport)	30 % ... 70 %

Standards and regulations

Connection in acc. with standard	IEC 61984
----------------------------------	-----------

Mounting

Assembly instructions	Use of a parallel pressing tool is recommended for easy latching of the COMBI connector and coupling elements for self-assembly
-----------------------	---

PP 2,5/ 1-M - Plug

3211274

<https://www.phoenixcontact.com/pc/products/3211274>



Drawings

Circuit diagram



PP 2,5/ 1-M - Plug

3211274

<https://www.phoenixcontact.com/pc/products/3211274>

Schematic diagram

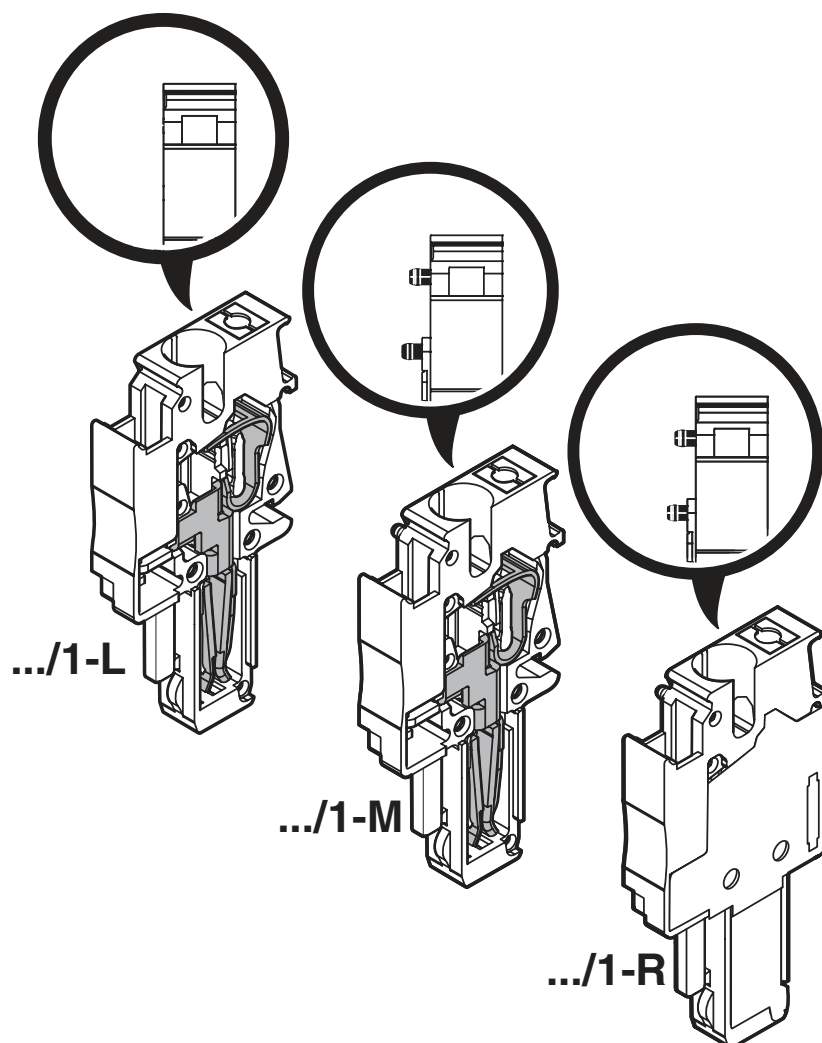

PP 2,5/ 1-M - Plug





3211274

<https://www.phoenixcontact.com/pc/products/3211274>

Approvals

To download certificates, visit the product detail page: <https://www.phoenixcontact.com/pc/products/3211274>

 CSA Approval ID: 13631				
	Nominal voltage U_N	Nominal current I_N	Cross section AWG	Cross section mm^2
Use group B	600 V	20 A	26 - 12	-
Use group C	600 V	20 A	26 - 12	-

 EAC Approval ID: RU C-DE.BL08.B.00511				
---	--	--	--	--

 cULus Recognized Approval ID: E60425				
--	--	--	--	--

 cULus Recognized Approval ID: E60425				
--	--	--	--	--

PP 2,5/ 1-M - Plug

3211274

<https://www.phoenixcontact.com/pc/products/3211274>



Classifications

ECLASS

ECLASS-11.0	27141151
ECLASS-12.0	27141151
ECLASS-13.0	27250306

ETIM

ETIM 8.0	EC002021
----------	----------

UNSPSC

UNSPSC 21.0	39121400
-------------	----------

PP 2,5/ 1-M - Plug

3211274

<https://www.phoenixcontact.com/pc/products/3211274>



Environmental product compliance

China RoHS	Environmentally friendly use period: unlimited = EFUP-e No hazardous substances above threshold values
------------	---

PP 2,5/ 1-M - Plug

3211274

<https://www.phoenixcontact.com/pc/products/3211274>



Accessories

MPS-MT - Test plugs

0201744

<https://www.phoenixcontact.com/pc/products/0201744>



Test plugs, with solder connection up to 1 mm² conductor cross section, number of positions: 1, color: gray

MPS-IH RD - Insulating sleeve

0201676

<https://www.phoenixcontact.com/pc/products/0201676>

Insulating sleeve, color: red



PP 2,5/ 1-M - Plug

3211274

<https://www.phoenixcontact.com/pc/products/3211274>



PRZ - Latching

3040614

<https://www.phoenixcontact.com/pc/products/3040614>



Latching, number of positions: 2, length: 64 mm, color: orange

PR - Latching

3040559

<https://www.phoenixcontact.com/pc/products/3040559>



Latching, length: 29.8 mm, width: 4.4 mm, height: 29.8 mm, number of positions: 1, color: orange

PP 2,5/ 1-M - Plug

3211274

<https://www.phoenixcontact.com/pc/products/3211274>



PZ/2 - Strain relief

3040627

<https://www.phoenixcontact.com/pc/products/3040627>



Strain relief, length: 48.7 mm, width: 9.3 mm, height: 48.7 mm, number of positions: 2, color: black

PZ/4 - Strain relief

3040643

<https://www.phoenixcontact.com/pc/products/3040643>



Strain relief, length: 48.7 mm, width: 19.6 mm, height: 48.7 mm, number of positions: 4, color: black

PP 2,5/ 1-M - Plug

3211274

<https://www.phoenixcontact.com/pc/products/3211274>



PR/2 - Latching

3040630

<https://www.phoenixcontact.com/pc/products/3040630>



Latching, length: 29.8 mm, width: 10 mm, height: 29.8 mm, number of positions: 2, color: orange

PRT/2 - Latching

3040631

<https://www.phoenixcontact.com/pc/products/3040631>



Latching, can only be released using a screwdriver, length: 23.2 mm, width: 9 mm, height: 23.2 mm, number of positions: 2, color: orange

PP 2,5/ 1-M - Plug

3211274

<https://www.phoenixcontact.com/pc/products/3211274>



PP 2,5/ 1-L - Plug

3211271

<https://www.phoenixcontact.com/pc/products/3211271>



Plug, left element, nom. voltage: 800 V, nominal current: 24 A, number of connections: 1, number of positions: 1, connection method: Push-in connection, 1 level, Rated cross section: 2.5 mm², cross section: 0.14 mm² - 4 mm², color: gray

PP 2,5/ 1-L BU - Plug

3211272

<https://www.phoenixcontact.com/pc/products/3211272>



Plug, left element, nom. voltage: 800 V, nominal current: 24 A, number of connections: 1, number of positions: 1, connection method: Push-in connection, 1 level, Rated cross section: 2.5 mm², cross section: 0.14 mm² - 4 mm², color: blue

PP 2,5/ 1-M - Plug

3211274

<https://www.phoenixcontact.com/pc/products/3211274>



PP 2,5/ 1-L GNYE - Plug

3211273

<https://www.phoenixcontact.com/pc/products/3211273>

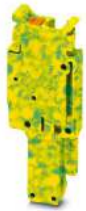

Plug, left element, nom. voltage: 800 V, nominal current: 24 A, number of connections: 1, number of positions: 1, connection method: Push-in connection, 1 level, Rated cross section: 2.5 mm², cross section: 0.14 mm² - 4 mm², color: green-yellow

PP 2,5/ 1-M - Plug

3211274

<https://www.phoenixcontact.com/pc/products/3211274>



Plug, center element, nom. voltage: 800 V, nominal current: 24 A, number of connections: 1, number of positions: 1, connection method: Push-in connection, 1 level, Rated cross section: 2.5 mm², cross section: 0.14 mm² - 4 mm², color: gray

PP 2,5/ 1-M - Plug

3211274

<https://www.phoenixcontact.com/pc/products/3211274>



PP 2,5/ 1-M BU - Plug

3211275

<https://www.phoenixcontact.com/pc/products/3211275>



Plug, center element, nom. voltage: 800 V, nominal current: 24 A, number of connections: 1, number of positions: 1, connection method: Push-in connection, 1 level, Rated cross section: 2.5 mm², cross section: 0.14 mm² - 4 mm², color: blue

PP 2,5/ 1-M GNYE - Plug

3211276

<https://www.phoenixcontact.com/pc/products/3211276>



Plug, center element, nom. voltage: 800 V, nominal current: 24 A, number of connections: 1, number of positions: 1, connection method: Push-in connection, 1 level, Rated cross section: 2.5 mm², cross section: 0.14 mm² - 4 mm², color: green-yellow

PP 2,5/ 1-M - Plug

3211274

<https://www.phoenixcontact.com/pc/products/3211274>



PP 2,5/ 1-R - Plug

3211277

<https://www.phoenixcontact.com/pc/products/3211277>



Plug, right element, nom. voltage: 800 V, nominal current: 24 A, number of connections: 1, number of positions: 1, connection method: Push-in connection, 1 level, Rated cross section: 2.5 mm², cross section: 0.14 mm² - 4 mm², color: gray

PP 2,5/ 1-R BU - Plug

3211278

<https://www.phoenixcontact.com/pc/products/3211278>



Plug, right element, nom. voltage: 800 V, nominal current: 24 A, number of connections: 1, number of positions: 1, connection method: Push-in connection, 1 level, Rated cross section: 2.5 mm², cross section: 0.14 mm² - 4 mm², color: blue

PP 2,5/ 1-M - Plug

3211274

<https://www.phoenixcontact.com/pc/products/3211274>



PP 2,5/ 1-R GNYE - Plug

3211279

<https://www.phoenixcontact.com/pc/products/3211279>

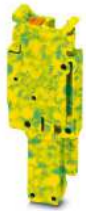

Plug, right element, nom. voltage: 800 V, nominal current: 24 A, number of connections: 1, number of positions: 1, connection method: Push-in connection, 1 level, Rated cross section: 2.5 mm², cross section: 0.14 mm² - 4 mm², color: green-yellow

ZBF 5:UNBEDRUCKT - Zack Marker strip, flat

0808642

<https://www.phoenixcontact.com/pc/products/0808642>



Zack Marker strip, flat, Strip, white, unlabeled, can be labeled with: PLOTMARK, CMS-P1-PLOTTER, mounting type: snapped, for terminal block width: 5 mm, lettering field size: 5.1 x 5.2 mm, Number of individual labels: 10

PP 2,5/ 1-M - Plug

3211274

<https://www.phoenixcontact.com/pc/products/3211274>



ZBF 5 CUS - Zack Marker strip, flat

0825025

<https://www.phoenixcontact.com/pc/products/0825025>



Zack Marker strip, flat, can be ordered: Strip, white, labeled according to customer specifications, mounting type: snap into flat marker groove, for terminal block width: 5 mm, lettering field size: 5.15 x 5.15 mm, Number of individual labels: 10

ZBF 5,LGS:FORTL.ZAHLEN - Zack Marker strip, flat

0808671

<https://www.phoenixcontact.com/pc/products/0808671>



Zack Marker strip, flat, Strip, white, labeled, printed horizontally: consecutive numbers 1 ... 10, 11 ... 20, etc. up to 491 ... 500, mounting type: snapped, for terminal block width: 5 mm, lettering field size: 5.15 x 5.15 mm, Number of individual labels: 10

PP 2,5/ 1-M - Plug

3211274

<https://www.phoenixcontact.com/pc/products/3211274>



ZBF 5,QR:FORTL.ZAHLEN - Zack Marker strip, flat

0808697

<https://www.phoenixcontact.com/pc/products/0808697>



Zack Marker strip, flat, Strip, white, labeled, Printed vertically: consecutive numbers 1 ... 10, 11 ... 20, etc. up to 91 ... 100, mounting type: snapped, for terminal block width: 5 mm, lettering field size: 5.15 x 5.15 mm, Number of individual labels: 10

ZBF 5,LGS:GERADE ZAHLEN - Zack Marker strip, flat

0810821

<https://www.phoenixcontact.com/pc/products/0810821>



Zack Marker strip, flat, Strip, white, labeled, printed horizontally: consecutive even numbers 2 ... 20, 22 ... 40, etc. up to 82 ... 100, mounting type: snapped, for terminal block width: 5 mm, lettering field size: 5.15 x 5.15 mm, Number of individual labels: 10

PP 2,5/ 1-M - Plug

3211274

<https://www.phoenixcontact.com/pc/products/3211274>



ZBF 5,LGS:UNGERADE ZAHLEN - Zack Marker strip, flat

0810863

<https://www.phoenixcontact.com/pc/products/0810863>



Zack Marker strip, flat, Strip, white, labeled, printed horizontally: Odd numbers 1 - 19, 21 - 39, etc. up to 81 - 99, mounting type: snapped, for terminal block width: 5 mm, lettering field size: 5.15 x 5.15 mm, Number of individual labels: 10

UC-TMF 5 - Marker for terminal blocks

0818153

<https://www.phoenixcontact.com/pc/products/0818153>



Marker for terminal blocks, Sheet, white, unlabeled, can be labeled with: BLUEMARK ID COLOR, BLUEMARK ID, BLUEMARK CLED, PLOTMARK, CMS-P1-PLOTTER, mounting type: snapped, for terminal block width: 5.2 mm, lettering field size: 4.6 x 5.1 mm, Number of individual labels: 96

PP 2,5/ 1-M - Plug

3211274

<https://www.phoenixcontact.com/pc/products/3211274>



UC-TMF 5 CUS - Marker for terminal blocks

0824638

<https://www.phoenixcontact.com/pc/products/0824638>



Marker for terminal blocks, can be ordered: by sheet, white, labeled according to customer specifications, mounting type: snap into flat marker groove, for terminal block width: 5.2 mm, lettering field size: 4.6 x 5.1 mm, Number of individual labels: 96

UCT-TMF 5 - Marker for terminal blocks

0828744

<https://www.phoenixcontact.com/pc/products/0828744>



Marker for terminal blocks, Sheet, white, unlabeled, can be labeled with: TOPMARK NEO, TOPMARK LASER, BLUEMARK ID COLOR, BLUEMARK ID, BLUEMARK CLED, THERMOMARK PRIME, THERMOMARK CARD 2.0, THERMOMARK CARD, mounting type: snapped, for terminal block width: 5.2 mm, lettering field size: 4.4 x 4.7 mm, Number of individual labels: 72

PP 2,5/ 1-M - Plug

3211274

<https://www.phoenixcontact.com/pc/products/3211274>



UCT-TMF 5 CUS - Marker for terminal blocks

0829658

<https://www.phoenixcontact.com/pc/products/0829658>



Marker for terminal blocks, can be ordered: by sheet, white, labeled according to customer specifications, mounting type: snap into flat marker groove, for terminal block width: 5.2 mm, lettering field size: 4.4 x 4.7 mm, Number of individual labels: 72

Phoenix Contact 2023 © - all rights reserved

<https://www.phoenixcontact.com>

PHOENIX CONTACT GmbH & Co. KG

Flachsmarktstraße 8

D-32825 Blomberg

+49 (0) 5235-3 00

info@phoenixcontact.com