

STRADA-SQ-FS-NP

Forward throw beam for area lighting

TECHNICAL SPECIFICATIONS:

Dimensions	25.0 x 25.0 mm
Height	12.4 mm
Fastening	glue
ROHS compliant	yes ⓘ

MATERIAL SPECIFICATIONS:

Component	Type	Material	Colour	Finish
STRADA-SQ-FS-NP	Single lens	PMMA	clear	

ORDERING INFORMATION:

Component	Qty in box	MOQ	MPQ	Box weight (kg)
C13757_STRADA-SQ-FS-NP » Box size: 480 x 280 x 300 mm	1568	294	98	6.1



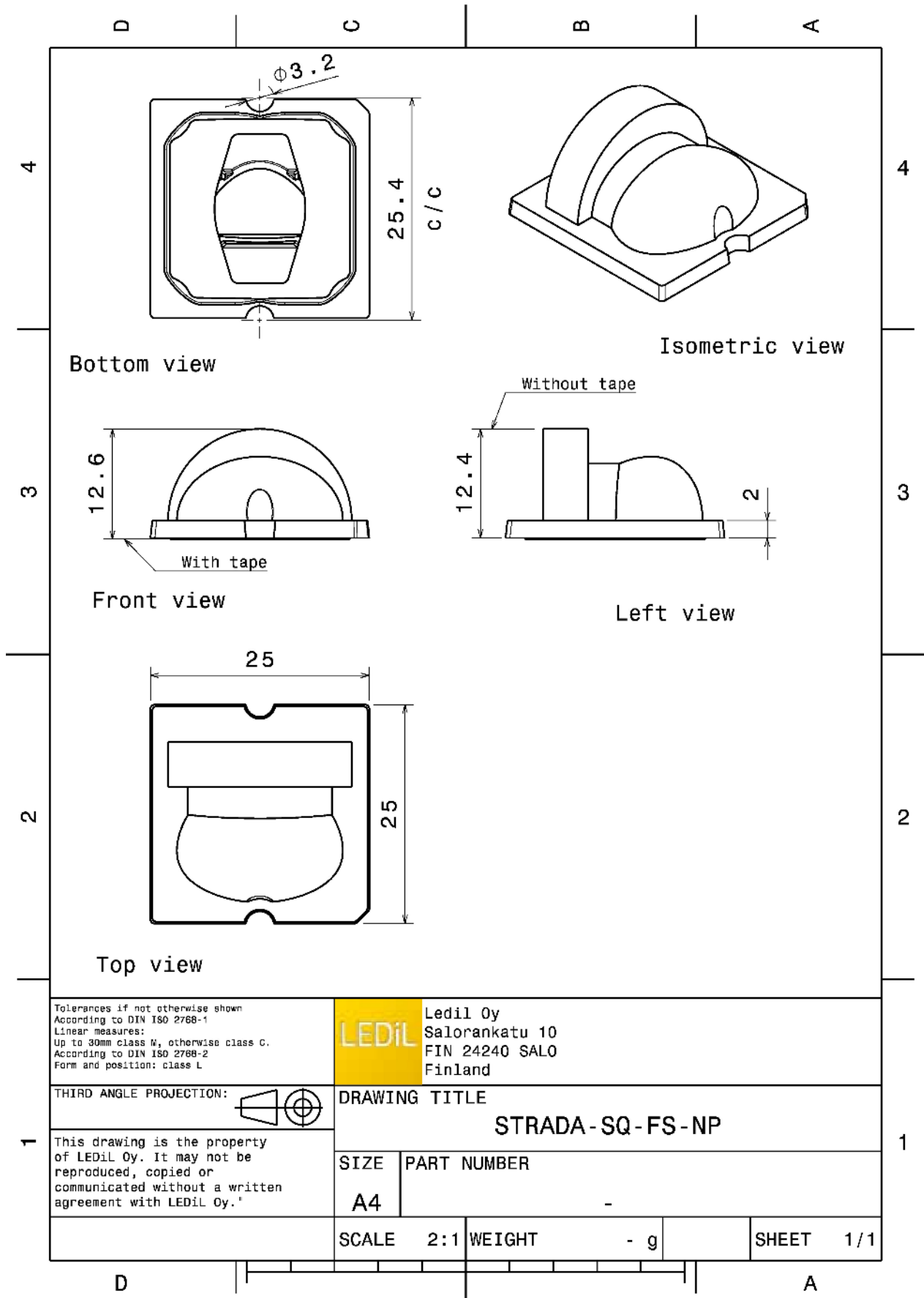

Tolerances if not otherwise shown
 According to DIN ISO 2768-1
 Linear measures:
 Up to 30mm class M, otherwise class C.
 According to DIN ISO 2768-2
 Form and position: class L



Ledil Oy
 Salorankatu 10
 FIN 24240 SALO
 Finland

THIRD ANGLE PROJECTION:

DRAWING TITLE

STRADA - SQ - FS - NP

This drawing is the property of LEDiL Oy. It may not be reproduced, copied or communicated without a written agreement with LEDiL Oy.

SIZE

PART NUMBER

A4

-

SCALE

2:1

WEIGHT

- g

SHEET

1/1

See also our general installation guide: www.ledil.com/installation_guide

PHOTOMETRIC DATA (MEASURED):

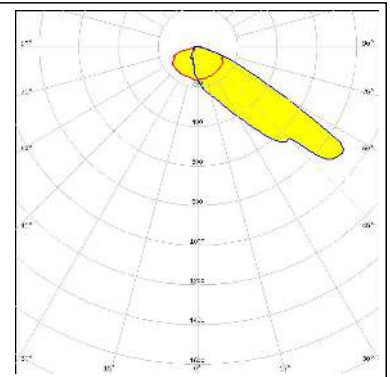
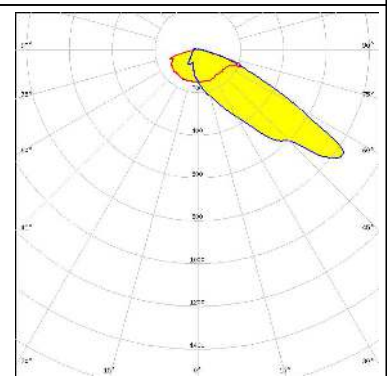
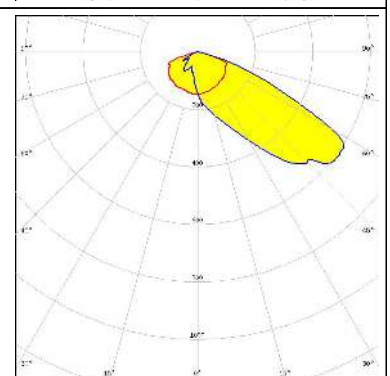
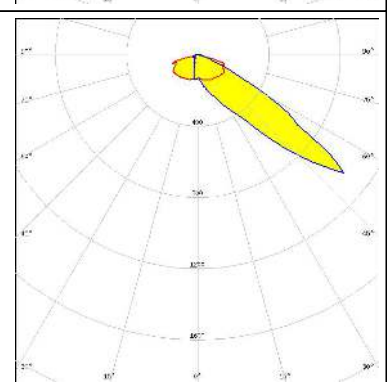
<p>CREE ⇄ LED</p> <p>LED MK-R FWHM / FWTM Asymmetric Efficiency 93 % Peak intensity 0.9 cd/lm LEDs/each optic 1 Light colour White Required components:</p>	
<p>CREE ⇄ LED</p> <p>LED XHP50 FWHM / FWTM Asymmetric Efficiency 94 % Peak intensity 0.9 cd/lm LEDs/each optic 1 Light colour White Required components:</p>	
<p>CREE ⇄ LED</p> <p>LED XHP70 FWHM / FWTM Asymmetric Efficiency 80 % Peak intensity 0.6 cd/lm LEDs/each optic 1 Light colour White Required components:</p> <p style="background-color: #e0f0ff; padding: 2px;">Protective plate, glass</p>	
<p>CREE ⇄ LED</p> <p>LED XM-L FWHM / FWTM Asymmetric Efficiency 93 % Peak intensity 1.2 cd/lm LEDs/each optic 1 Light colour White Required components:</p>	

PHOTOMETRIC DATA (MEASURED):

CREE LED

LED XP-L HD
 FWHM / FWTM Asymmetric
 Efficiency 94 %
 Peak intensity 1.1 cd/lm
 LEDs/each optic 1
 Light colour White
 Required components:

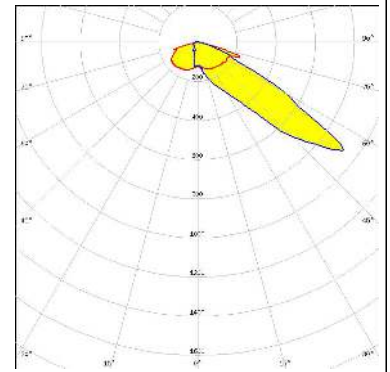

CREE LED

LED XP-L2
 FWHM / FWTM Asymmetric
 Efficiency 94 %
 Peak intensity 0.8 cd/lm
 LEDs/each optic 1
 Light colour White
 Required components:

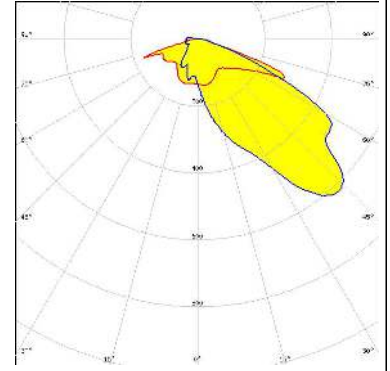

CREE LED

LED XT-E
 FWHM / FWTM Asymmetric
 Efficiency 93 %
 Peak intensity 1.2 cd/lm
 LEDs/each optic 1
 Light colour White
 Required components:

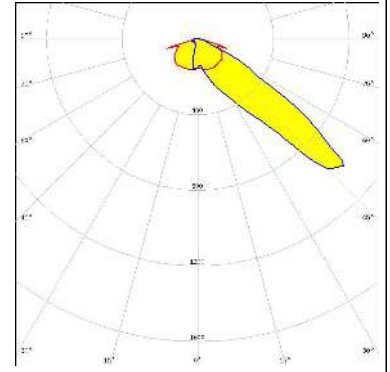

LUMILEDS

LED LUXEON M/MX
 FWHM / FWTM Asymmetric
 Efficiency 92 %
 Peak intensity 0.9 cd/lm
 LEDs/each optic 1
 Light colour White
 Required components:

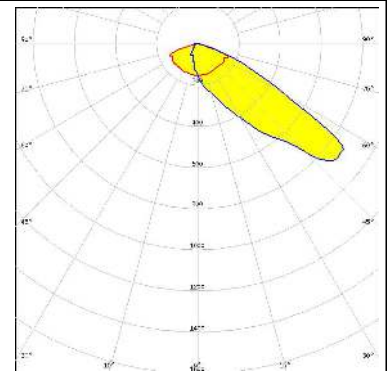

PHOTOMETRIC DATA (SIMULATED):

<p>CREE LED</p> <p>LED: XHP50.3 HD FWHM / FWTM: Asymmetric Efficiency: 94 % Peak intensity: 0.9 cd/lm LEDs/each optic: 1 Light colour: White Required components:</p>	
<p>CREE LED</p> <p>LED: XHP70.3 HD FWHM / FWTM: Asymmetric Efficiency: 93 % Peak intensity: 0.7 cd/lm LEDs/each optic: 1 Light colour: White Required components:</p>	
<p>OSRAM <small>Opto Semiconductors</small></p> <p>LED: OSCONIQ P 7070 FWHM / FWTM: Asymmetric Efficiency: 91 % Peak intensity: 1.1 cd/lm LEDs/each optic: 1 Light colour: White Required components:</p>	

GENERAL INFORMATION:

NOTE: The typical beam angle will be changed by different color, chip size and chip position tolerance. The typical total beam angle is the full angle measured where the luminous intensity is half of the peak value.

MATERIALS:

As part of our continuous research and improvement processes, and to ensure the best possible quality and availability of our products, LEDiL reserves the right to change material grades without notice.

PRODUCT DATA USER AGREEMENT AND DISCLAIMER:

The measured data in the provided downloadable LEDiL Product Datasheets and Mechanical 2D-Drawings is rounded and provided as reference for planning. LEDiL Oy's optical specifications have been verified by conducting performance testing of the products in accordance with the company's quality system. The reported data are averaged results of multiple measurements with typical variation. LEDiL Oy reserves the right to without prior notification make changes and improvements to its products.

LEDiL Oy assumes neither warranty, nor guarantee nor any other liability of any kind for the contents and correctness of the provided data. The provided data has been generated with highest diligence but the provided data may in reality not represent the complete possible variation range of all intrinsic parameters. Therefore, in certain cases a deviation from the provided data could occur.

LEDiL Oy reserves the right to undertake technical changes of its products without further notification which could lead to changes in the provided data. LEDiL Oy assumes no liability of any kind for the possible deviation from any provided data or any other damage resulting from the usage of the provided data.

The user agrees to this disclaimer and user agreement with the download or usage of the provided files.

LEDiL Oy

Joensuunkatu 13
FI-24240 SALO
Finland

LEDiL Inc.

228 West Page Street
Suite D
Sycamore IL 60178
USA

Ledil Optics Technology (Shenzhen) Co., Ltd.

405 , Block B
Casic Motor Building
Shenzhen 518057
P.R.CHINA

Local sales and technical support

[www.ledil.com/
where_to_buy](http://www.ledil.com/where_to_buy)

Shipping locations

Salo, Finland
Hong Kong, China

Distribution Partners

[www.ledil.com/
where_to_buy](http://www.ledil.com/where_to_buy)