



## 90 Degree Drop-In Hybrid Coupler From 130 MHz to 180 MHz Rated to 200 Watts

### Hybrids Technical Data Sheet

PE2CP1032

#### Features

- High Power
- 20 dB isolation
- 130 MHz to 180 MHz Frequency Range
- Gold Plated Silver Leads
- 2.2 inch by 0.8 inch package
- Clear Chem Film Per MIL-DTL-5541

#### Applications

- Test and measurement
- Military Communications
- Commercial Communications
- Wireless Communications
- SATCOM
- Military Electronic Systems

#### Description

The PE2CP1032 operates from 130 MHz to 180 MHz and can handle 200 watts of power with 20 dB isolation. The package is 2.2 inch by 0.8 inch with gold plated silver leads and can be attached to a heat sink and PCB by screws. Gold plated leads are resistant to oxidation for ease of soldering and ensuring superior electrical performance of 1.25:1 VSWR and an insertion loss of 0.25 dB.

The PE2CP1032 is part of Pasternack's family of 90 degree hybrid couplers in drop-in packages. These couplers feature small drop-in packages that can handle power up to 1,000 Watts. They are available in both narrow and broad bandwidths. These quadrature hybrids are excellent for any situation to either equally split an input signal into two paths with a 90 degree phase shift between them or to combine two signals while maintaining high isolation between them.

#### Electrical Specifications

Description	Minimum	Typical	Maximum	Units
Frequency Range	130		180	MHz
Impedance		50		Ohms
Phase Difference		90		Degrees
Insertion Loss			0.25	dB
Isolation	20			dB
VSWR			1.25:1	
Amplitude Balance		0.4		dB
Phase Balance		5		Degrees
Input Power (CW)			200	Watts

Click the following link (or enter part number in "SEARCH" on website) to obtain additional part information including price, inventory and certifications: [90 Degree Drop-In Hybrid Coupler From 130 MHz to 180 MHz Rated to 200 Watts PE2CP1032](#)

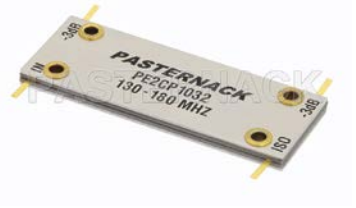

90 Degree Drop-In Hybrid Coupler From  
130 MHz to 180 MHz Rated to 200 Watts

Hybrids Technical Data Sheet

PE2CP1032

**Mechanical Specifications**

**Size**

Length	2.2 in [55.88 mm]
Width	0.8 in [20.32 mm]
Height	0.15 in [3.81 mm]
Weight	0.051 lbs [23.13 g]

**Configuration**

RF Connector Type	Pin
Contact Material and Plating	Silver, Gold

**Environmental Specifications**

**Temperature**

Operating Range	-55 to +85 deg C
-----------------	------------------

**Compliance Certifications** (see [product page](#) for current document)

**Plotted and Other Data**

Notes:

**Typical Performance Data**

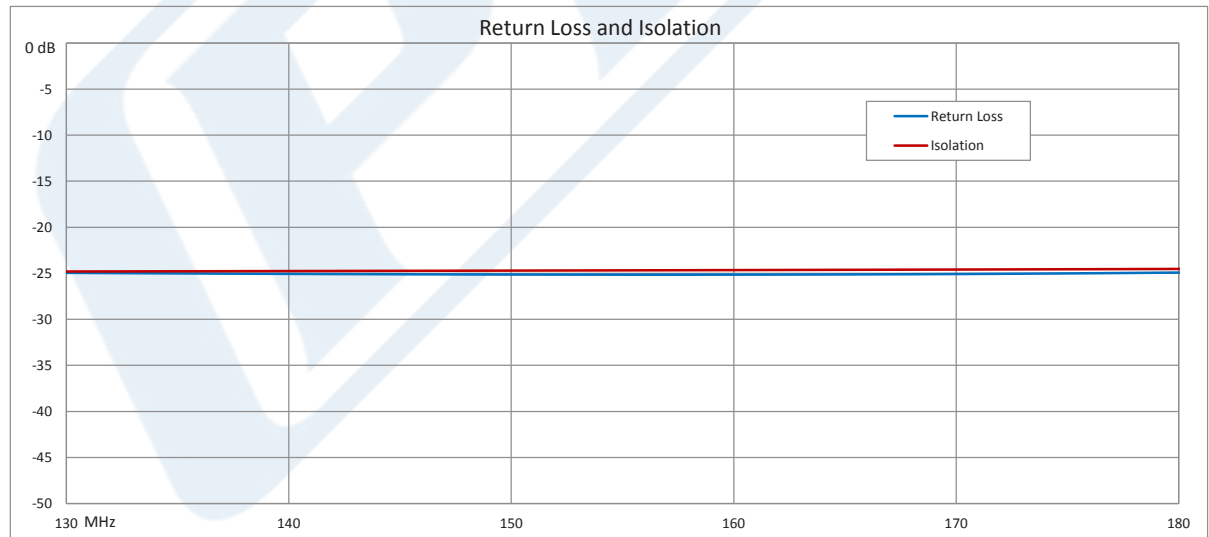

Click the following link (or enter part number in "SEARCH" on website) to obtain additional part information including price, inventory and certifications: [90 Degree Drop-In Hybrid Coupler From 130 MHz to 180 MHz Rated to 200 Watts PE2CP1032](#)

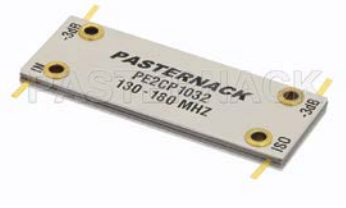

90 Degree Drop-In Hybrid Coupler From  
130 MHz to 180 MHz Rated to 200 Watts

Hybrids Technical Data Sheet

PE2CP1032

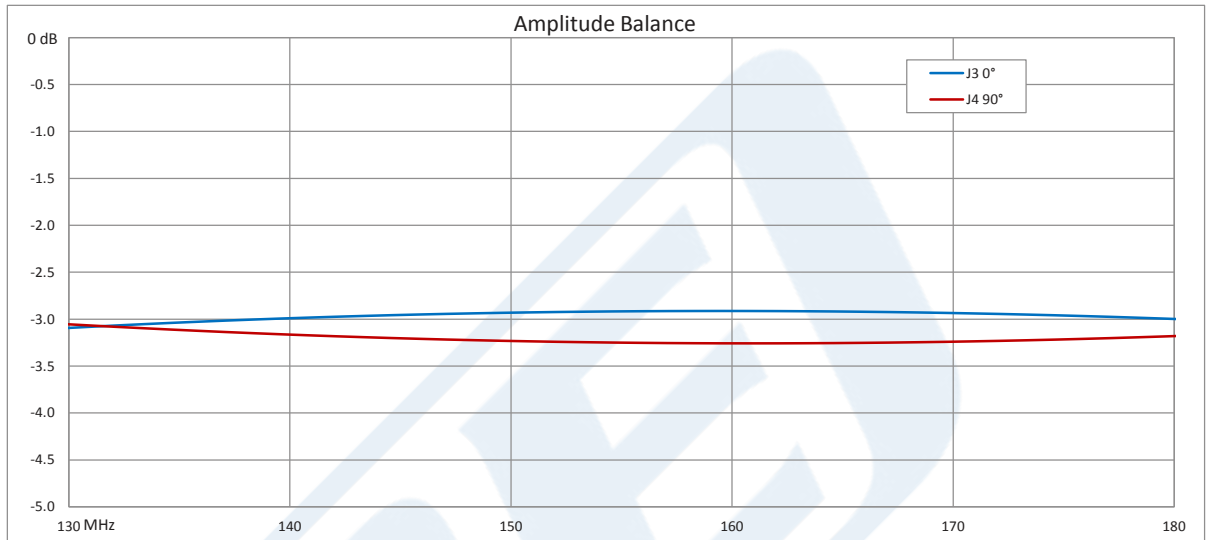

Click the following link (or enter part number in "SEARCH" on website) to obtain additional part information including price, inventory and certifications: [90 Degree Drop-In Hybrid Coupler From 130 MHz to 180 MHz Rated to 200 Watts PE2CP1032](#)



## 90 Degree Drop-In Hybrid Coupler From 130 MHz to 180 MHz Rated to 200 Watts

### Hybrids Technical Data Sheet

PE2CP1032

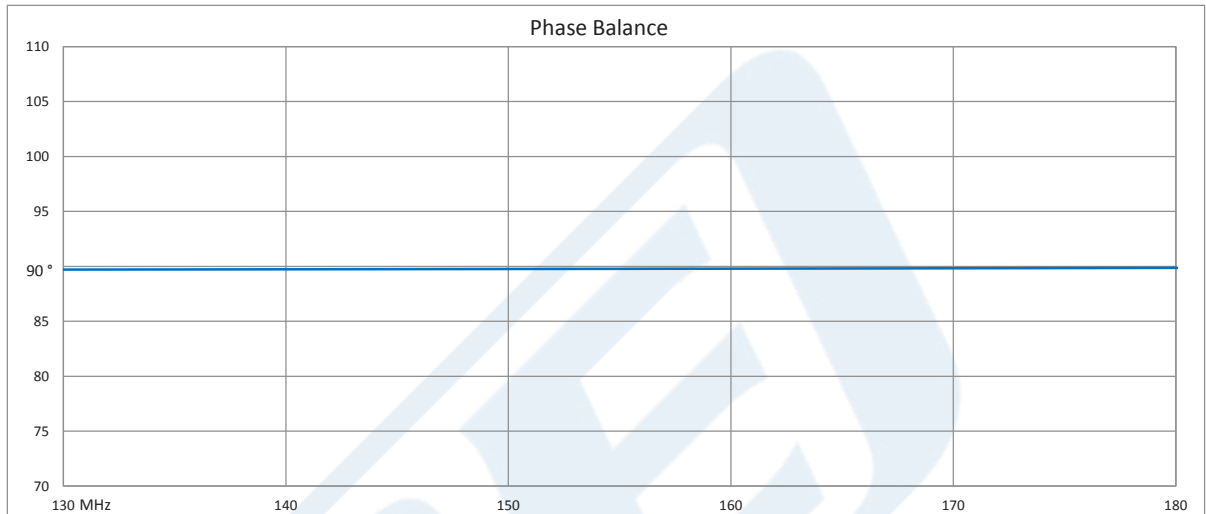

90 Degree Drop-In Hybrid Coupler From 130 MHz to 180 MHz Rated to 200 Watts from Pasternack Enterprises has same day shipment for domestic and International orders. Our RF, microwave and millimeter wave products maintain a 99.4% availability and are part of the broadest selection in the industry.

Click the following link (or enter part number in "SEARCH" on website) to obtain additional part information including price, inventory and certifications: [90 Degree Drop-In Hybrid Coupler From 130 MHz to 180 MHz Rated to 200 Watts PE2CP1032](https://www.pasternack.com/drop-in-coupler-130-180-mhz-200-watts-pe2cp1032-p.aspx)

URL: <https://www.pasternack.com/drop-in-coupler-130-180-mhz-200-watts-pe2cp1032-p.aspx>

The information contained in this document is accurate to the best of our knowledge and representative of the part described herein. It may be necessary to make modifications to the part and/or the documentation of the part, in order to implement improvements. Pasternack reserves the right to make such changes as required. Unless otherwise stated, all specifications are nominal. Pasternack does not make any representation or warranty regarding the suitability of the part described herein for any particular purpose, and Pasternack does not assume any liability arising out of the use of any part or documentation.

# PE2CP1032 CAD Drawing

90 Degree Drop-In Hybrid Coupler From 130 MHz to 180 MHz Rated to 200 Watts

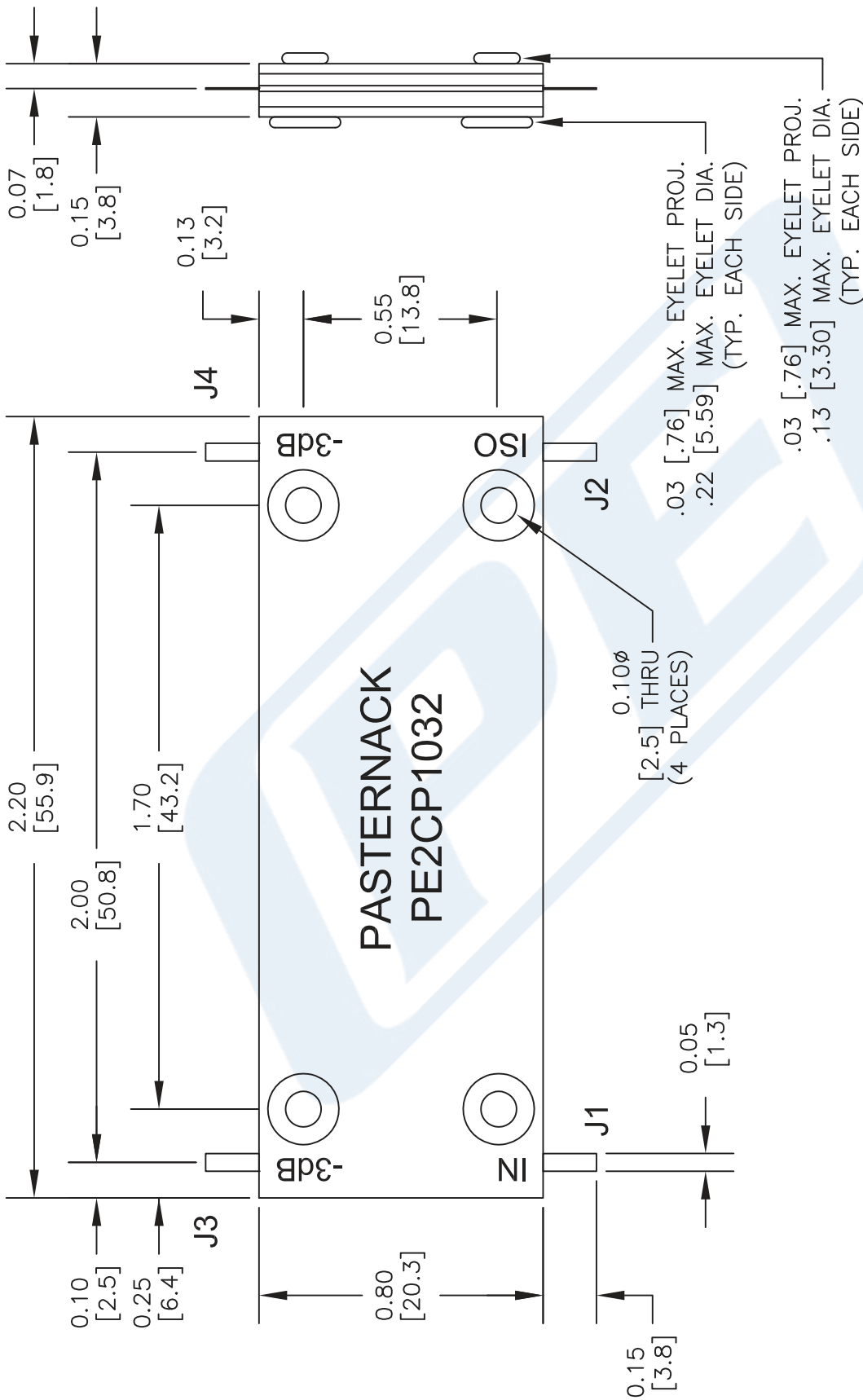

TOLERANCE .XX ± .02 [.50]  
IN [mm] .XXX ± .005 [.127]  
ANG. ± 1/2°

\* THESE DIMENSIONS AND TOLERANCES SUPERSEDE NOTE #1 ON TITLE BLOCK.

PORT CONFIGURATION				
INPUT	J1	J2	J3	J4
J1	---	ISOLATION	-3dB<0 DEG	-3dB<90 DEG
J2	ISOLATION	---	-3dB<90 DEG	-3dB<0 DEG
J3	-3dB<0 DEG	-3dB<90 DEG	---	ISOLATION
J4	-3dB<90 DEG	-3dB<0 DEG	ISOLATION	---

NOTES:  
1. UNLESS OTHERWISE SPECIFIED ALL DIMENSIONS ARE NOMINAL.  
2. ALL SPECIFICATIONS ARE SUBJECT TO CHANGE WITHOUT NOTICE AT ANY TIME.  
3. DIMENSIONS ARE IN INCHES [mm].

DWG TITLE  
**PE2CP1032**

FSCM NO. 53919

CAD FILE 121015

SCALE N/A

SIZE A

2233

**PE PASTERNAK**  
THE ENGINEER'S RF SOURCE  
Pasternack Enterprises, Inc.  
P.O. Box 16759 | Irvine | CA | 92623  
Phone: (949) 261-1920 | Fax: (949) 261-7451  
Website: www.pasternack.com | E-Mail: sales@pasternack.com

# PE2CP1032 CAD Drawing

90 Degree Drop-In Hybrid Coupler From 130 MHz to 180 MHz Rated to 200 Watts

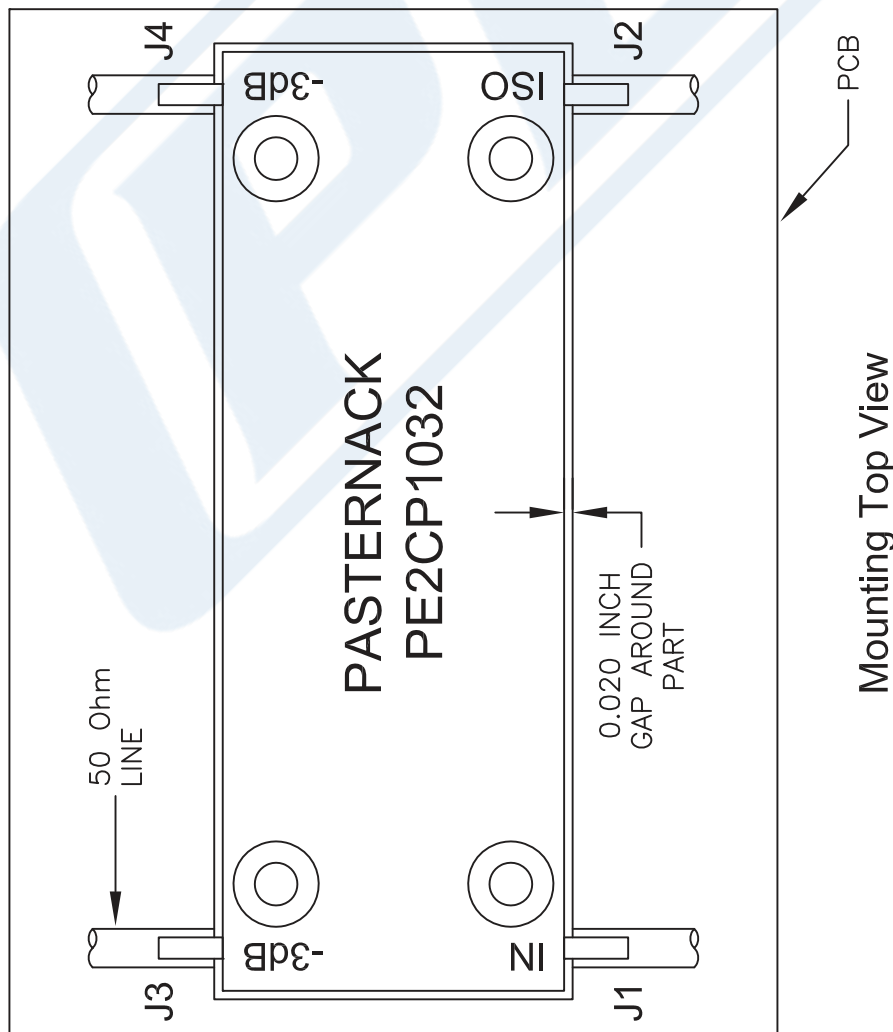
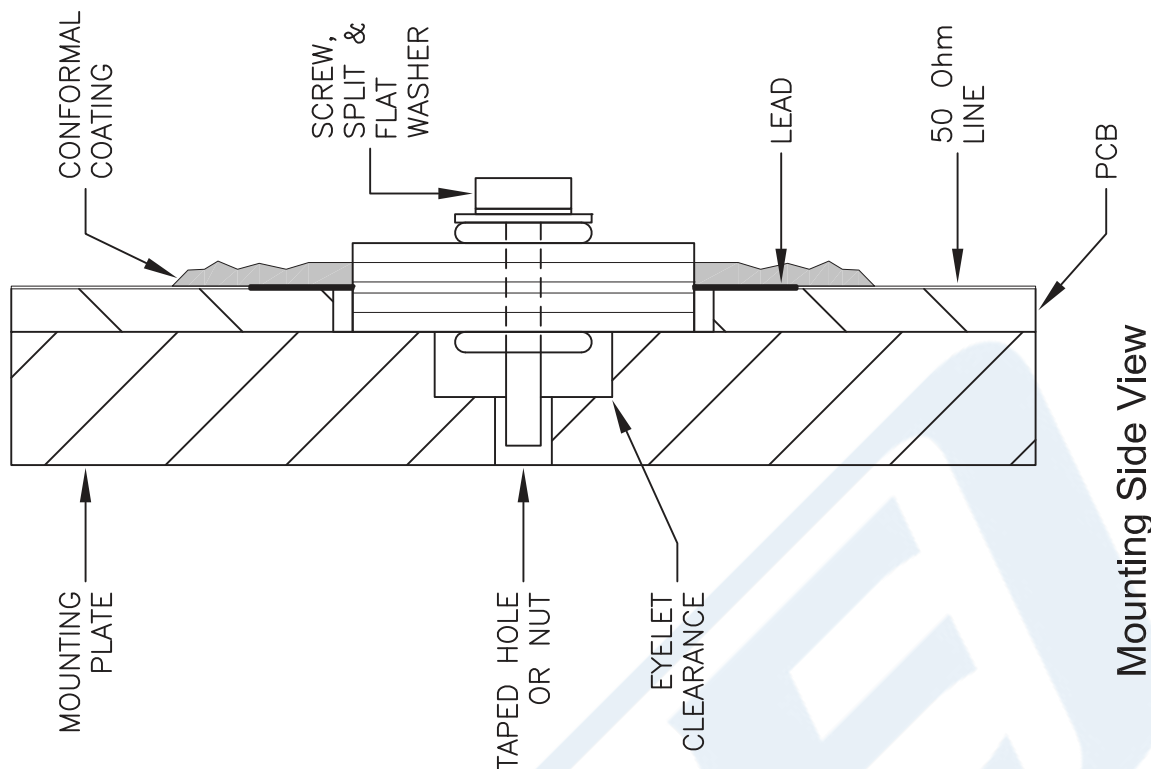

**NOTE:**

1. CONFORMAL COATING IS RECOMMENDED AT THE LEAD / 50 Ohm LINE INTERFACE FOR HIGH POWER APPLICATIONS TO PREVENT VOLTAGE ARCING.
2. TO INSURE PROPER GROUNDING THE BOTTOM PLATE OF COUPLER MUST LAY FLAT ON MOUNTING SURFACE. PLEASE ALLOW CLEARANCE FOR ALL EYELET PROJECTIONS IN BASE PLATE.
3. SOLDER LEADS TO 50 Ohm LINES USING LEAD FREE OR Sn63 ALLOY.
4. TORQUE STAINLESS STEEL SCREW, SPLIT AND FLAT WASHER TO 2.5 in.-lbs.

DWG TITLE

**PE2CP1032**

- NOTES:
1. UNLESS OTHERWISE SPECIFIED ALL DIMENSIONS ARE NOMINAL.
  2. ALL SPECIFICATIONS ARE SUBJECT TO CHANGE WITHOUT NOTICE AT ANY TIME.
  3. DIMENSIONS ARE IN INCHES [mm].

**PE PASTERNAK**  
THE ENGINEER'S RF SOURCE  
Pasternack Enterprises, Inc.  
P.O. Box 16759 | Irvine | CA | 92623  
Phone: (949) 261-1920 | Fax: (949) 261-7451  
Website: [www.pasternack.com](http://www.pasternack.com) | E-Mail: [sales@pasternack.com](mailto:sales@pasternack.com)

FSCM NO. 53919

CAD FILE 121015

SCALE N/A

SIZE A

2233