

BROOKE-G2-M

~30° medium beam compatible with LEDiL HEKLA.

SPECIFICATION:

Dimensions	Ø 45.0 mm
Height	18.9 mm
Fastening	socket
ROHS compliant	yes ⓘ

MATERIALS:

Component	Type	Material	Colour	Finish	Coating
BROOKE-G2-M	Reflector	PC	metal		HMDS

ORDERING INFORMATION:





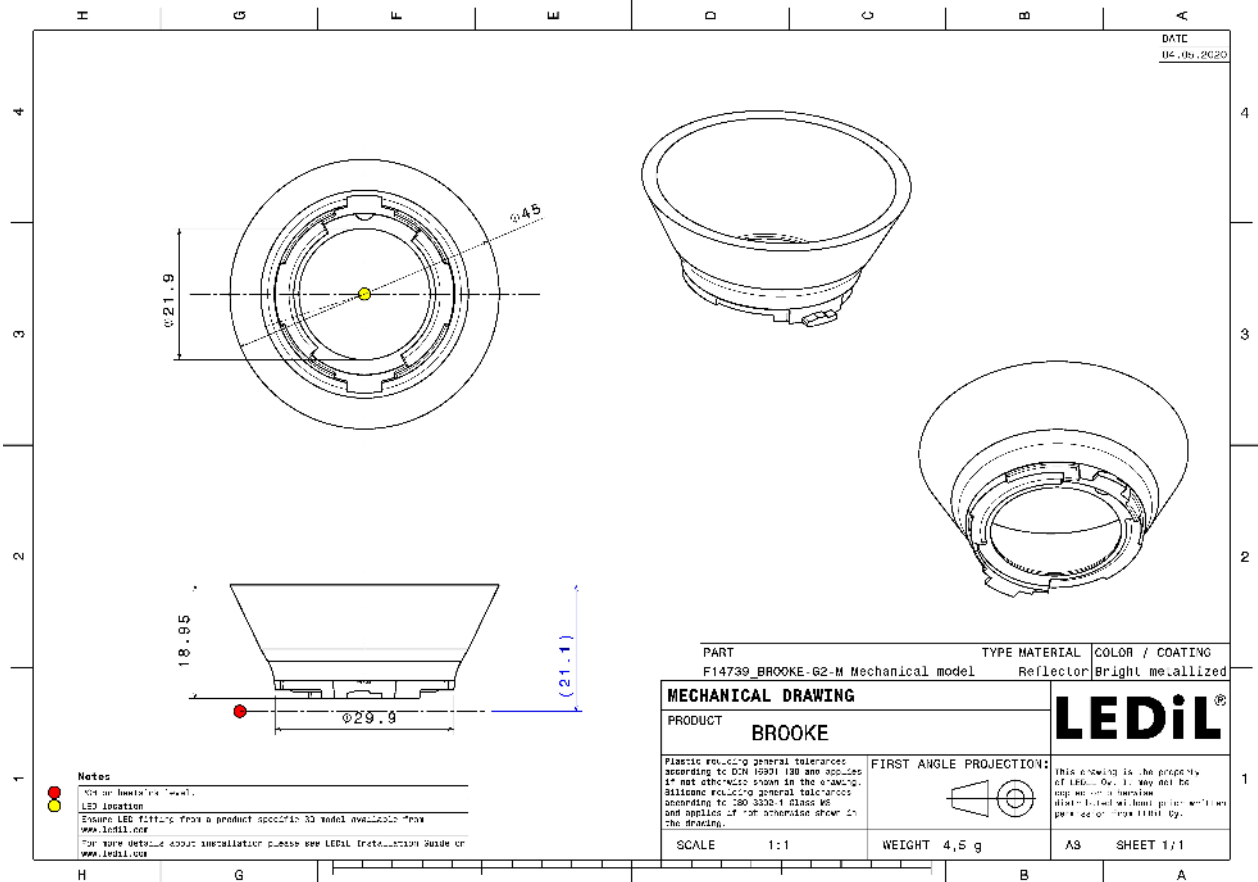

Component	Qty in box	MOQ	MPQ	Box weight (kg)
F14739_BROOKE-G2-M » Box size: 480 x 280 x 300 mm	720	45	45	5.0



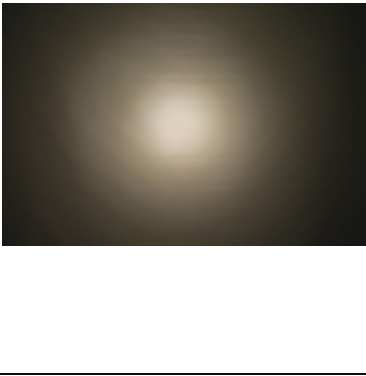
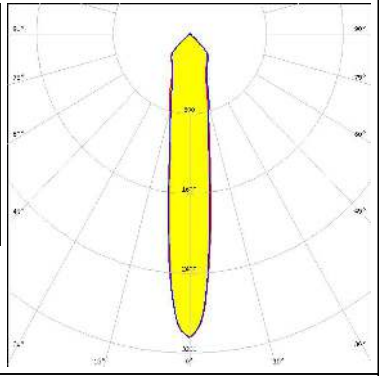

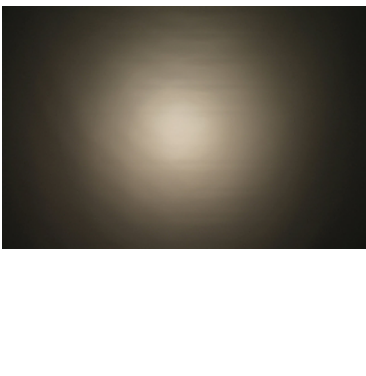
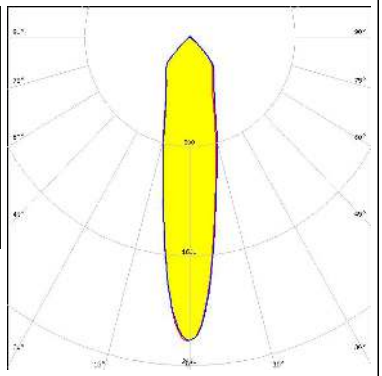

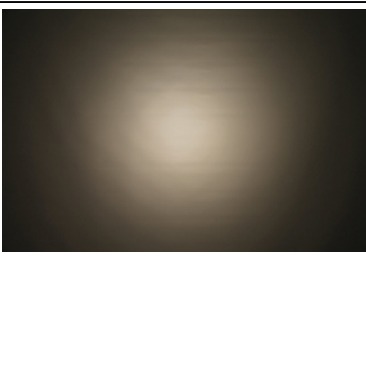
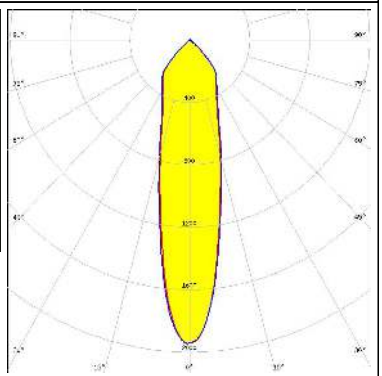

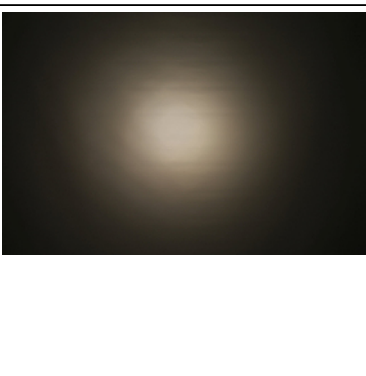
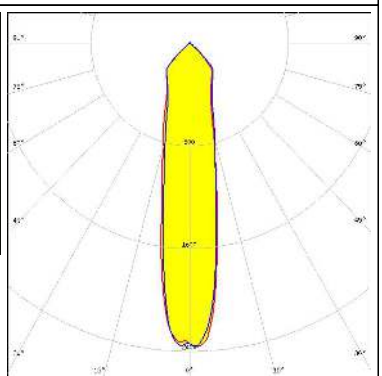



See also our general installation guide: www.ledil.com/installation_guide

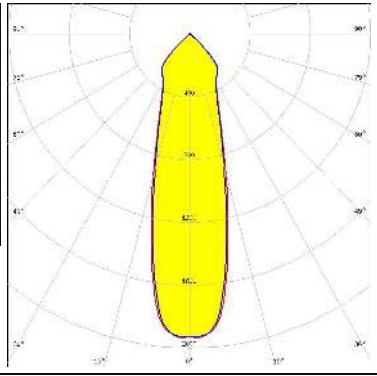

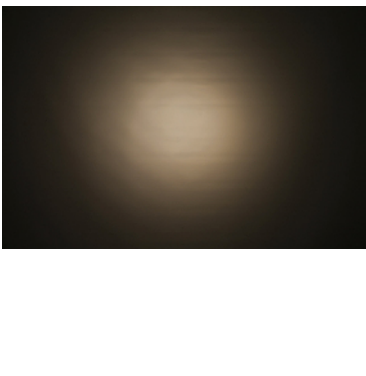
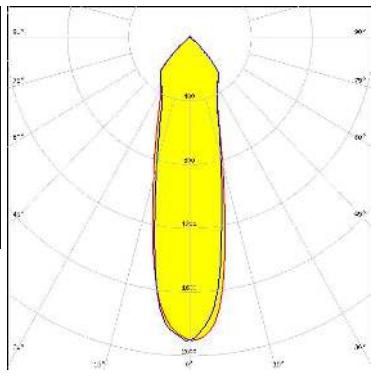

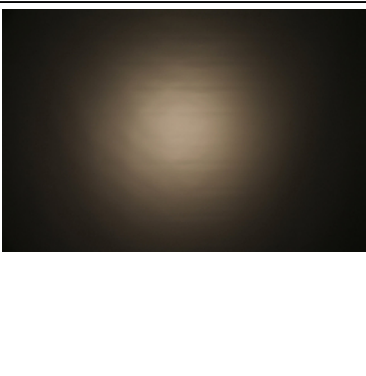
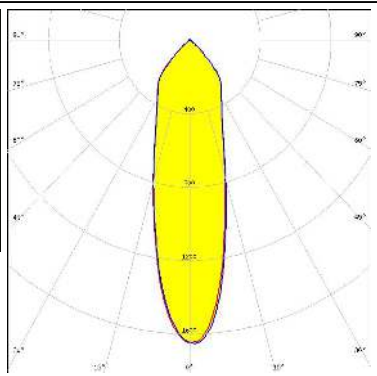

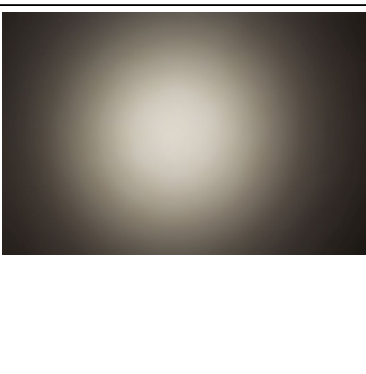
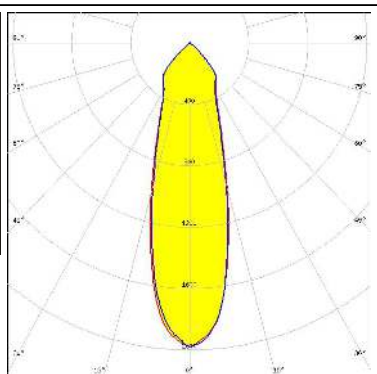
OPTICAL RESULTS (MEASURED):

<p></p> <p>LED V4 HD Gen 7 FWHM / FWTM 16.0° / 76.0° Efficiency 94 % Peak intensity 3.1 cd/lm LEDs/each optic 1 Light colour White Required components: F15253_HEKLA-SOCKET-A</p>		
<p></p> <p>LED V4 HD Gen 7 FWHM / FWTM 21.0° / 86.0° Efficiency 90 % Peak intensity 2.2 cd/lm LEDs/each optic 1 Light colour White Required components: F15253_HEKLA-SOCKET-A C14658_BARBARA-RZ-LENS</p>		
<p></p> <p>LED V6 HD Gen 7 FWHM / FWTM 24.0° / 87.0° Efficiency 89 % Peak intensity 2 cd/lm LEDs/each optic 1 Light colour White Required components: F15255_HEKLA-SOCKET-C C14658_BARBARA-RZ-LENS</p>		
<p></p> <p>LED V6 HD Gen 7 FWHM / FWTM 21.0° / 87.0° Efficiency 94 % Peak intensity 2.4 cd/lm LEDs/each optic 1 Light colour White Required components: F15255_HEKLA-SOCKET-C</p>		

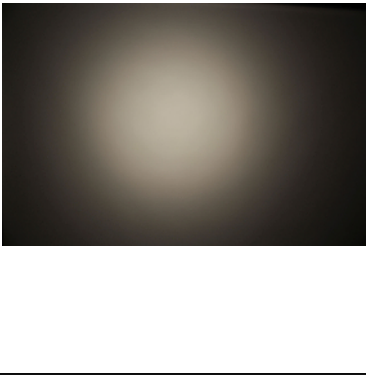
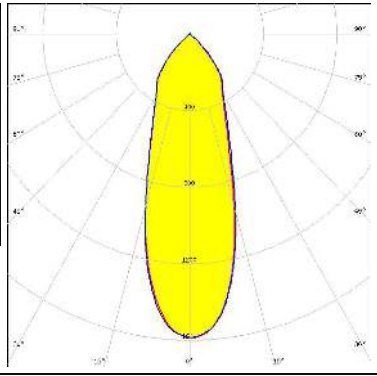

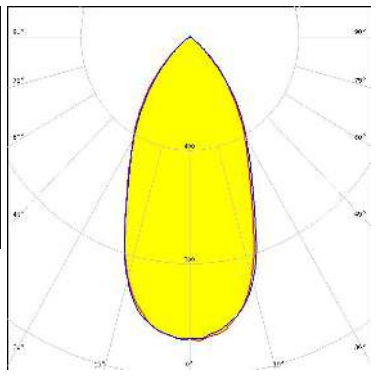

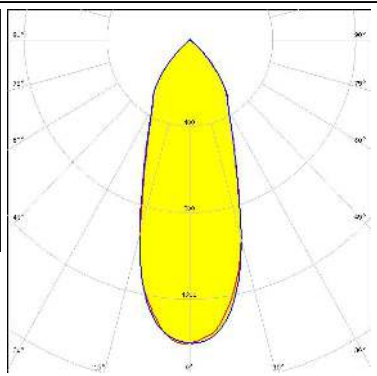

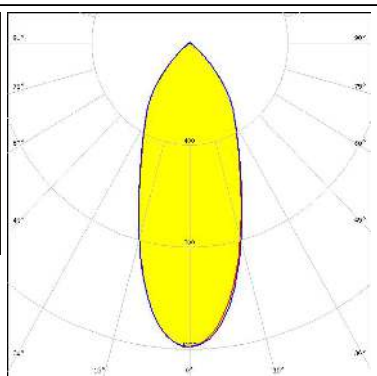
OPTICAL RESULTS (MEASURED):

<p></p> <p>LED V8 Gen 8 FWHM / FWTM 29.0° / 89.0° Efficiency 95 % Peak intensity 1.9 cd/lm LEDs/each optic 1 Light colour White Required components: F15253_HEKLA-SOCKET-A</p>		
<p></p> <p>LED V9 HD Gen7 FWHM / FWTM 27.0° / 89.0° Efficiency 94 % Peak intensity 1.9 cd/lm LEDs/each optic 1 Light colour White Required components: F15859_HEKLA-SOCKET-I</p>		
<p></p> <p>LED V9 HD Gen7 FWHM / FWTM 29.0° / 89.0° Efficiency 87 % Peak intensity 1.7 cd/lm LEDs/each optic 1 Light colour White Required components: F15859_HEKLA-SOCKET-I C14658_BARBARA-RZ-LENS</p>		
<p></p> <p>LED VERO10 FWHM / FWTM 30.0° / 88.0° Efficiency 94 % Peak intensity 2 cd/lm LEDs/each optic 1 Light colour White Required components: F15616_HEKLA-SOCKET-F</p>		

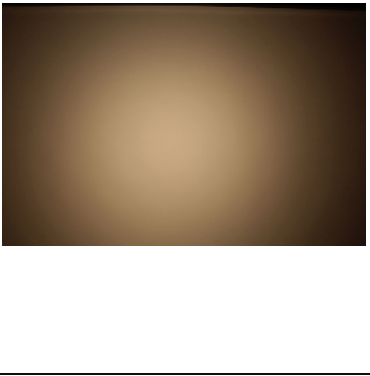
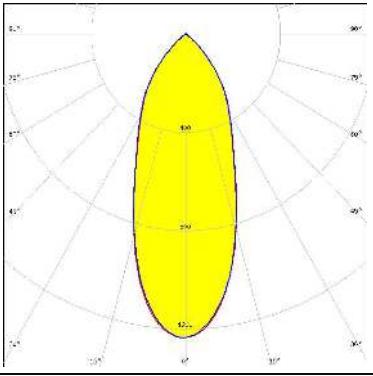

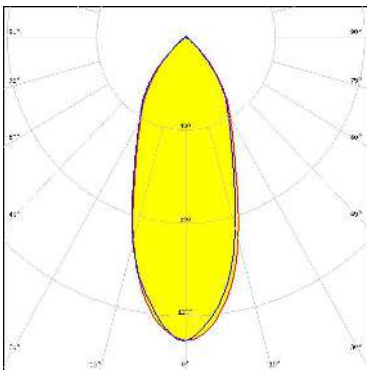

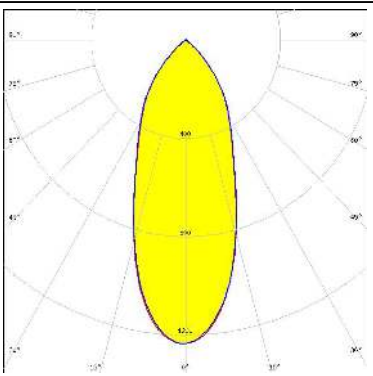

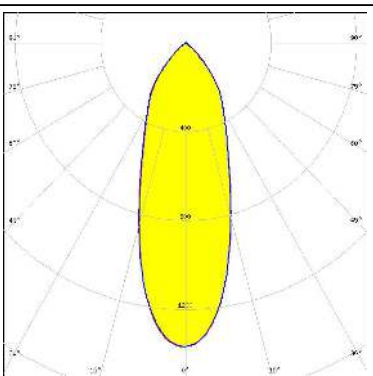
OPTICAL RESULTS (MEASURED):

<p></p> <p>LED VERO13 FWHM / FWTM 34.0° / 87.0° Efficiency 90 % Peak intensity 1.6 cd/lm LEDs/each optic 1 Light colour White Required components: C16142_HEKLA-SOCKET-K</p>		
<p></p> <p>LED VERO18 FWHM / FWTM 50.0° / 93.0° Efficiency 89 % Peak intensity 1.1 cd/lm LEDs/each optic 1 Light colour White Required components: C16142_HEKLA-SOCKET-K</p>		
<p></p> <p>LED Vesta DTW 13mm (21W) FWHM / FWTM 38.0° / 88.0° Efficiency 90 % Peak intensity 1.4 cd/lm LEDs/each optic 1 Light colour Tunable White Required components: C16142_HEKLA-SOCKET-K Bender Wirth: 491 Typ L8</p>		
<p></p> <p>LED Vesta DTW 13mm (21W) FWHM / FWTM 41.0° / 91.0° Efficiency 84 % Peak intensity 1.2 cd/lm LEDs/each optic 1 Light colour Tunable White Required components: C16142_HEKLA-SOCKET-K C14658_BARBARA-RZ-LENS Bender Wirth: 491 Typ L8</p>		

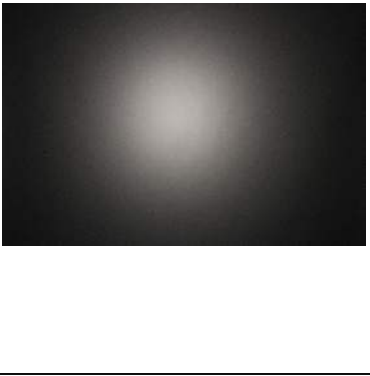
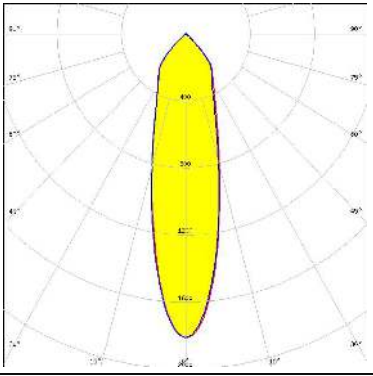
OPTICAL RESULTS (MEASURED):

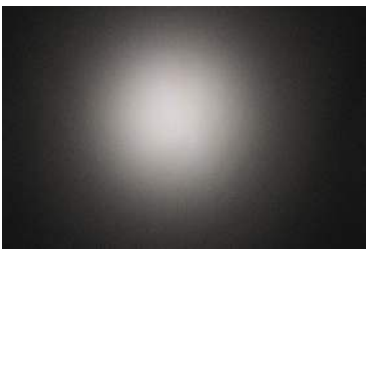
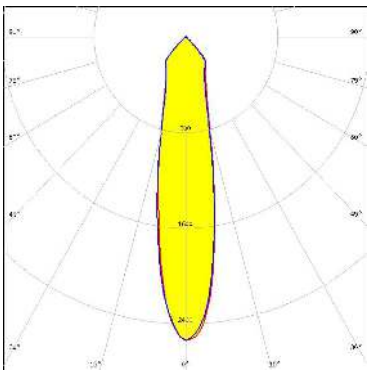
<p></p> <p>LED Vesta DTW 15mm (33W) FWHM / FWTM 40.0° / 89.0° Efficiency 84 % Peak intensity 1.2 cd/lm LEDs/each optic 1 Light colour White</p> <p>Required components: C16142_HEKLA-SOCKET-K C14658_BARBARA-RZ-LENS Bender Wirth: 491 Typ L8</p>		
<p></p> <p>LED Vesta DTW 15mm (33W) FWHM / FWTM 41.0° / 90.0° Efficiency 90 % Peak intensity 1.3 cd/lm LEDs/each optic 1 Light colour White</p> <p>Required components: C16142_HEKLA-SOCKET-K Bender Wirth: 491 Typ L8</p>		
<p></p> <p>LED Vesta DTW 9mm (4W/6W/12W) FWHM / FWTM 31.0° / 88.0° Efficiency 86 % Peak intensity 1.5 cd/lm LEDs/each optic 1 Light colour White</p> <p>Required components: C16142_HEKLA-SOCKET-K C14658_BARBARA-RZ-LENS Bender Wirth: 490 Typ L8</p>		
<p></p> <p>LED Vesta TW 13mm (25W) CSP FWHM / FWTM 36.0° / 87.0° Efficiency 84 % Peak intensity 1.4 cd/lm LEDs/each optic 1 Light colour White</p> <p>Required components: C16142_HEKLA-SOCKET-K C14658_BARBARA-RZ-LENS Bender Wirth: 492 Typ L8</p>		

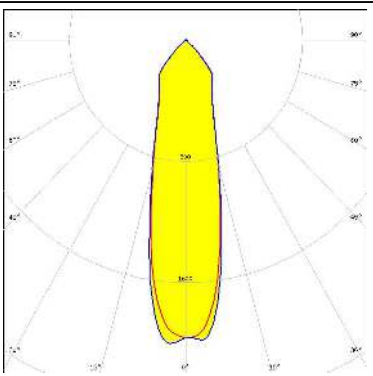
OPTICAL RESULTS (MEASURED):

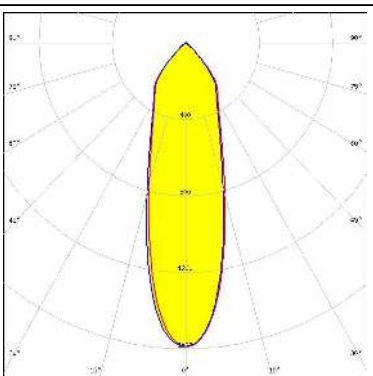
<p></p> <p>LED Vesta TW 6mm DP FWHM / FWTM 27.0° / 86.0° Efficiency 85 % Peak intensity 1.8 cd/m LEDs/each optic 1 Light colour White</p> <p>Required components: C16142_HEKLA-SOCKET-K C14658_BARBARA-RZ-LENS Bender Wirth: 504 Typ L8</p>		
<p></p> <p>LED Vesta TW 6mm DP FWHM / FWTM 22.0° / 82.0° Efficiency 89 % Peak intensity 2.5 cd/m LEDs/each optic 1 Light colour White</p> <p>Required components: C16142_HEKLA-SOCKET-K Bender Wirth: 504 Typ L8</p>		
<p></p> <p>LED Vesta TW 9mm (12W) CSP FWHM / FWTM 27.0° / 84.0° Efficiency 91 % Peak intensity 2 cd/m LEDs/each optic 1 Light colour White</p> <p>Required components: C16142_HEKLA-SOCKET-K Bender Wirth: 490 Typ L8</p>		
<p></p> <p>LED Vesta TW 9mm (12W) CSP FWHM / FWTM 30.0° / 86.0° Efficiency 85 % Peak intensity 1.6 cd/m LEDs/each optic 1 Light colour White</p> <p>Required components: C16142_HEKLA-SOCKET-K C14658_BARBARA-RZ-LENS Bender Wirth: 489 Typ L8</p>		

OPTICAL RESULTS (MEASURED):

CITIZEN

LED CLC020 Series (Dim-To-Warm)
 FWHM / FWTM 31.0° / 86.0°
 Efficiency 84 %
 Peak intensity 1.6 cd/lm
 LEDs/each optic 1
 Light colour White
 Required components:
 C16142_HEKLA-SOCKET-K
 C14658_BARBARA-RZ-LENS
 Bender Wirth: 487 Typ L8

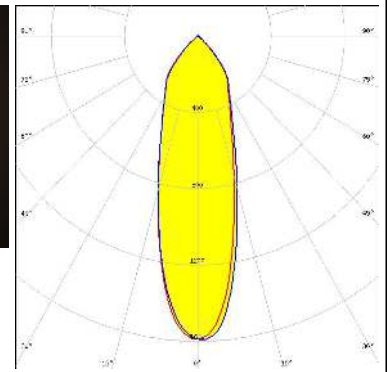

CITIZEN

LED CLC030 Series (Dim-To-Warm)
 FWHM / FWTM 41.0° / 90.0°
 Efficiency 82 %
 Peak intensity 1.2 cd/lm
 LEDs/each optic 1
 Light colour White
 Required components:
 C16142_HEKLA-SOCKET-K
 C14658_BARBARA-RZ-LENS
 Bender Wirth: 436 Typ L8

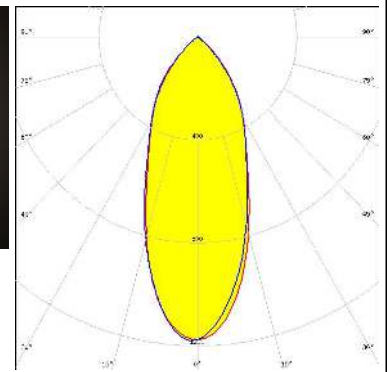
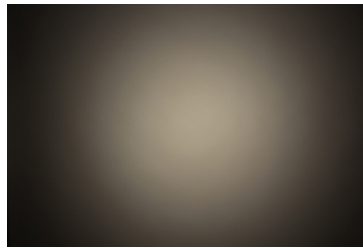

CITIZEN

LED CLC030 Series (Dim-To-Warm)
 FWHM / FWTM 38.0° / 88.0°
 Efficiency 88 %
 Peak intensity 1.4 cd/lm
 LEDs/each optic 1
 Light colour White
 Required components:
 C16142_HEKLA-SOCKET-K

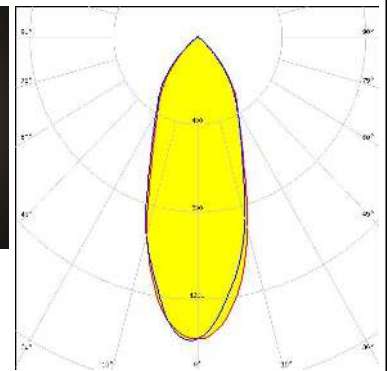
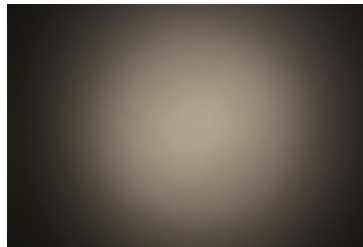

CITIZEN

LED CLU700/701/702/703
 FWHM / FWTM 23.0° / 84.0°
 Efficiency 94 %
 Peak intensity 2.6 cd/lm
 LEDs/each optic 1
 Light colour White
 Required components:
 F15255_HEKLA-SOCKET-C

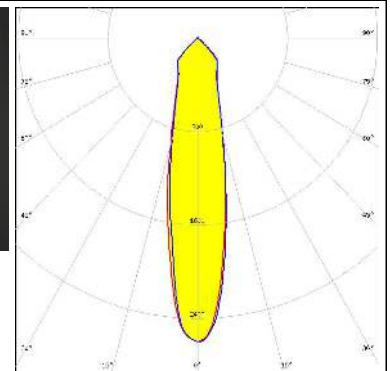
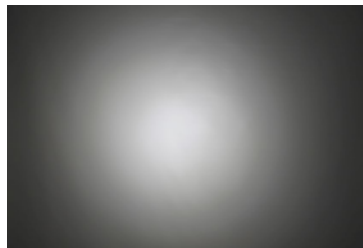

OPTICAL RESULTS (MEASURED):

CITIZEN

LED CLU700/701/702/703
 FWHM / FWTM 26.0° / 85.0°
 Efficiency 91 %
 Peak intensity 2.1 cd/m
 LEDs/each optic 1
 Light colour White
 Required components:
 F15255_HEKLA-SOCKET-C
 C14658_BARBARA-RZ-LENS

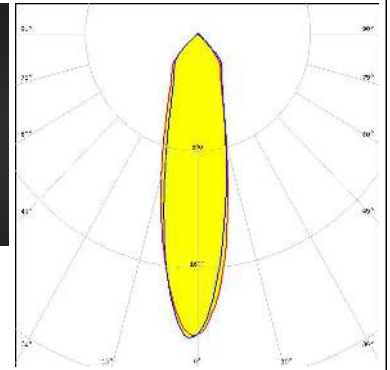

CITIZEN

LED CLU7A2/7A3
 FWHM / FWTM 16.0° / 68.0°
 Efficiency 94 %
 Peak intensity 3.2 cd/m
 LEDs/each optic 1
 Light colour White
 Required components:
 F15255_HEKLA-SOCKET-C

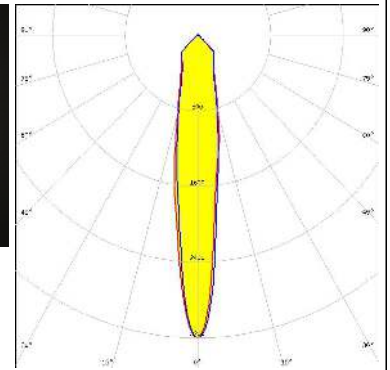

CITIZEN

LED LCN-C01B (Tunable White)
 FWHM / FWTM 29.0° / 85.0°
 Efficiency 86 %
 Peak intensity 1.7 cd/m
 LEDs/each optic 1
 Light colour White
 Required components:
 C16142_HEKLA-SOCKET-K
 C14658_BARBARA-RZ-LENS
 Bender Wirth: 481 Typ L8

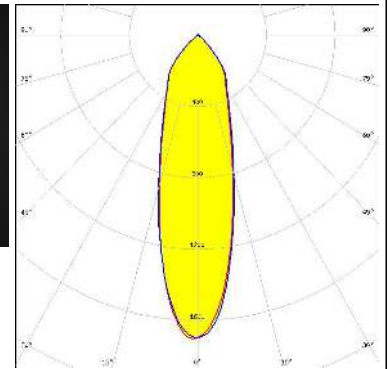
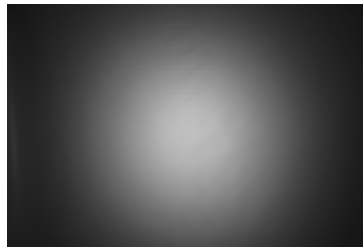

CITIZEN

LED LCN-C02B (Tunable White)
 FWHM / FWTM 36.0° / 87.0°
 Efficiency 90 %
 Peak intensity 1.5 cd/m
 LEDs/each optic 1
 Light colour White
 Required components:
 C16142_HEKLA-SOCKET-K

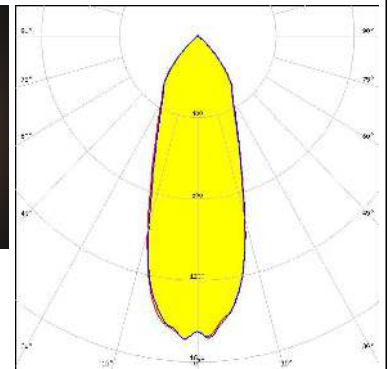
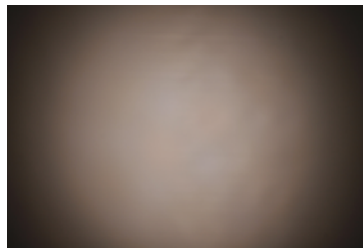

OPTICAL RESULTS (MEASURED):

CITIZEN

LED LCN-C02B (Tunable White)
 FWHM / FWTM 39.0° / 89.0°
 Efficiency 84 %
 Peak intensity 1.1 cd/lm
 LEDs/each optic 1
 Light colour White
 Required components:
 C16142_HEKLA-SOCKET-K
 C14658_BARBARA-RZ-LENS
 Bender Wirth: 481 Typ L8

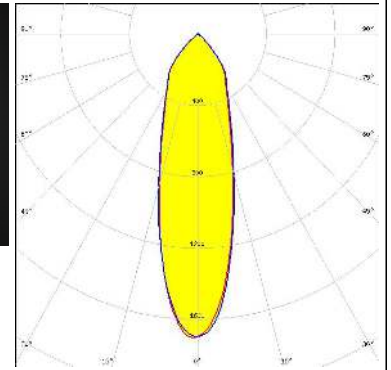
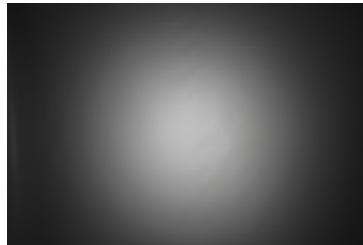

LED CMA1516
 FWHM / FWTM 29.0° / 90.0°
 Efficiency 94 %
 Peak intensity 1.8 cd/lm
 LEDs/each optic 1
 Light colour White
 Required components:
 F15256_HEKLA-SOCKET-D

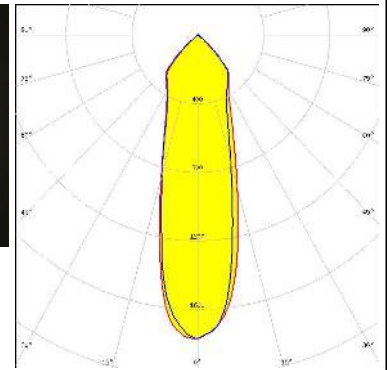
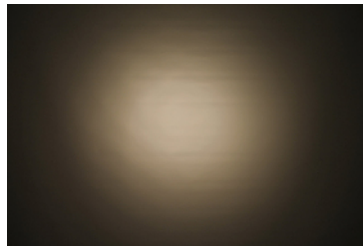



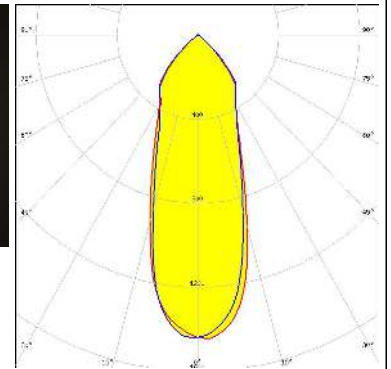
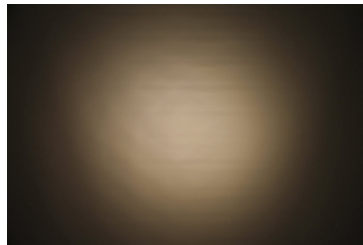

LED CMA1825
 FWHM / FWTM 36.0° / 92.0°
 Efficiency 94 %
 Peak intensity 1.4 cd/lm
 LEDs/each optic 1
 Light colour White
 Required components:
 F15254_HEKLA-SOCKET-B

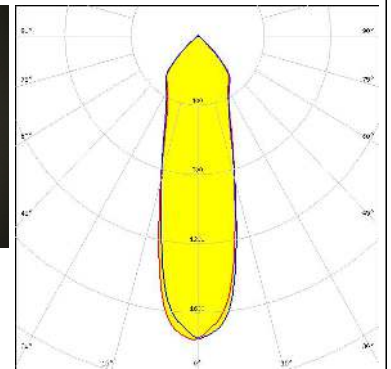
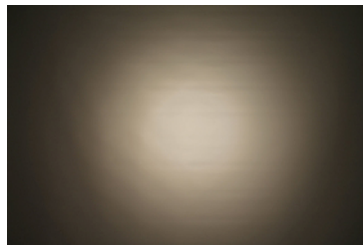

LED CMT14xx
 FWHM / FWTM 29.0° / 90.0°
 Efficiency 94 %
 Peak intensity 1.8 cd/lm
 LEDs/each optic 1
 Light colour White
 Required components:
 F15255_HEKLA-SOCKET-C

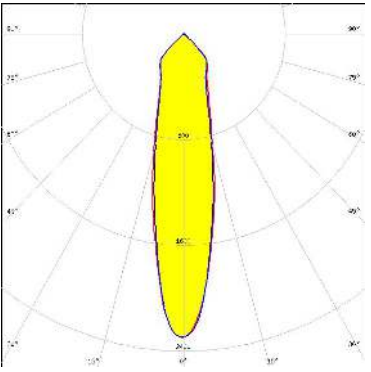
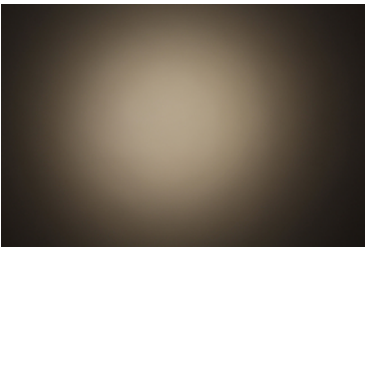
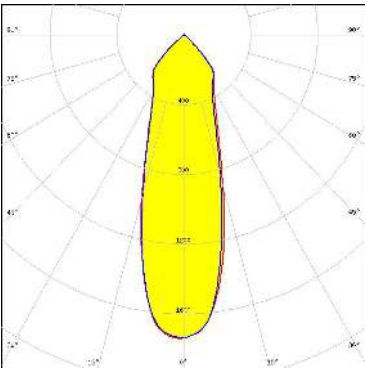

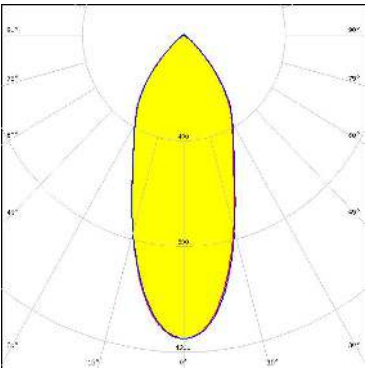

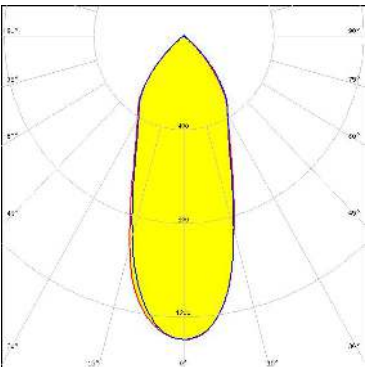

OPTICAL RESULTS (MEASURED):

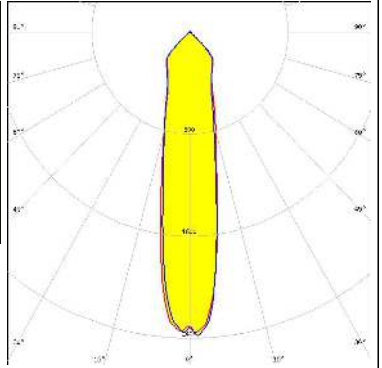
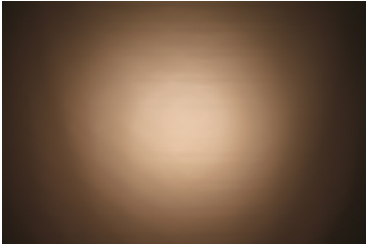
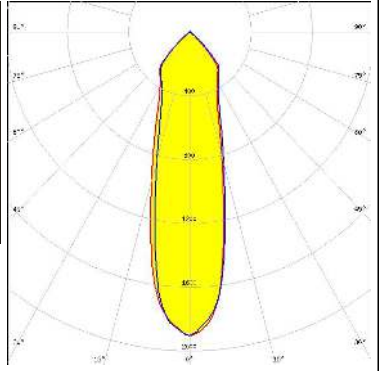
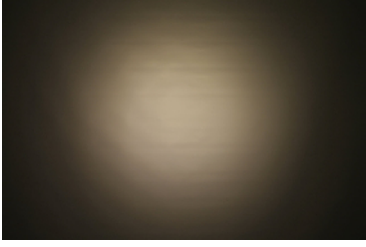
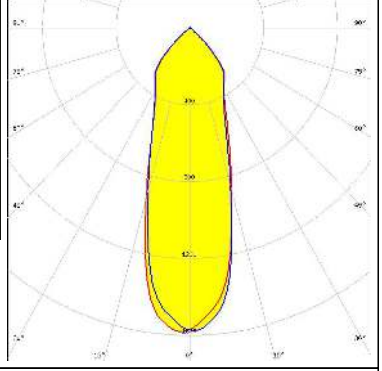
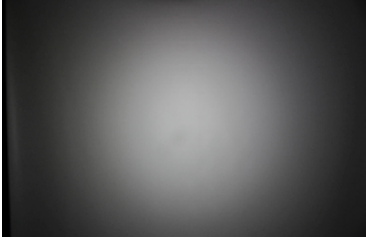
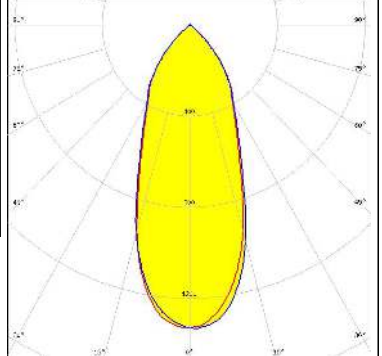
<p>CREE LEDs</p> <p>LED CXA/B 13xx FWHM / FWTM 25.0° / 88.0° Efficiency 94 % Peak intensity 2.3 cd/lm LEDs/each optic 1 Light colour White Required components: F15956_HEKLA-SOCKET-J</p>		
<p>CREE LEDs</p> <p>LED CXA/B 15xx FWHM / FWTM 32.0° / 90.0° Efficiency 94 % Peak intensity 1.7 cd/lm LEDs/each optic 1 Light colour White Required components: F15256_HEKLA-SOCKET-D</p>		
<p>LUMILEDS</p> <p>LED LUXEON CX Plus CoB L08 (Gen2) FWHM / FWTM 41.0° / 91.0° Efficiency 84 % Peak intensity 1.2 cd/lm LEDs/each optic 1 Light colour White Required components: C14658_BARBARA-RZ-LENS Bender Wirth: 637a Hekla</p>		
<p>LUMILEDS</p> <p>LED LUXEON CX Plus CoB L08 (Gen2) FWHM / FWTM 40.0° / 92.0° Efficiency 92 % Peak intensity 1.3 cd/lm LEDs/each optic 1 Light colour White Required components: Bender Wirth: 637a Hekla</p>		

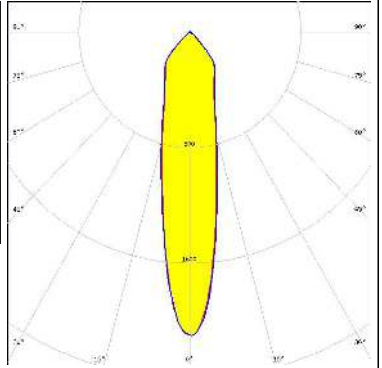

OPTICAL RESULTS (MEASURED):

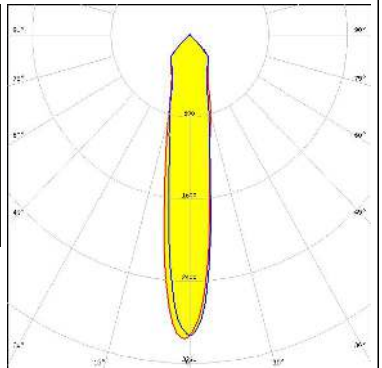
<p>LUMILEDS</p> <p>LED LUXEON CoB 1202HD</p> <p>FWHM / FWTM 22.0° / 87.0°</p> <p>Efficiency 95 %</p> <p>Peak intensity 2.4 cd/m</p> <p>LEDs/each optic 1</p> <p>Light colour White</p> <p>Required components: F15848_HEKLA-SOCKET-G</p>		
<p>LUMILEDS</p> <p>LED LUXEON CoB 1204HD</p> <p>FWHM / FWTM 28.0° / 89.0°</p> <p>Efficiency 96 %</p> <p>Peak intensity 1.9 cd/m</p> <p>LEDs/each optic 1</p> <p>Light colour White</p> <p>Required components: F15858_HEKLA-SOCKET-H</p>		
<p>LUMILEDS</p> <p>LED LUXEON CoB 1205HD</p> <p>FWHM / FWTM 33.0° / 90.0°</p> <p>Efficiency 94 %</p> <p>Peak intensity 1.6 cd/m</p> <p>LEDs/each optic 1</p> <p>Light colour White</p> <p>Required components: F15858_HEKLA-SOCKET-H</p>		
<p>LUMILEDS</p> <p>LED LUXEON CoB 1208</p> <p>FWHM / FWTM 41.0° / 90.0°</p> <p>Efficiency 92 %</p> <p>Peak intensity 1.3 cd/m</p> <p>LEDs/each optic 1</p> <p>Light colour White</p> <p>Required components: Bender Wirth: 632a Hekla XL</p>		

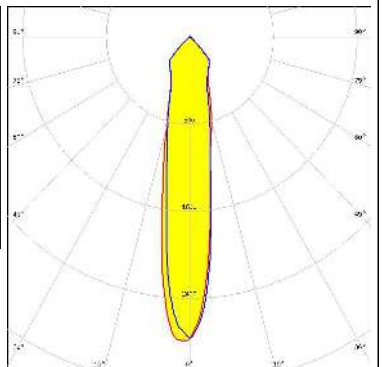
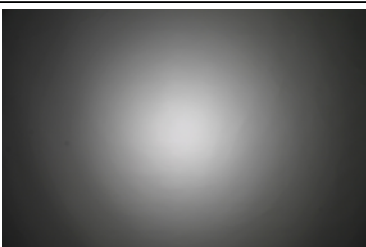
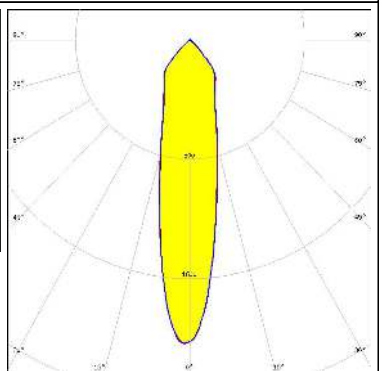



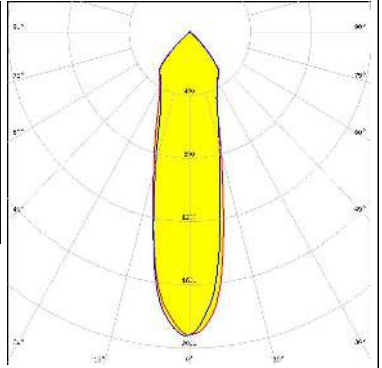
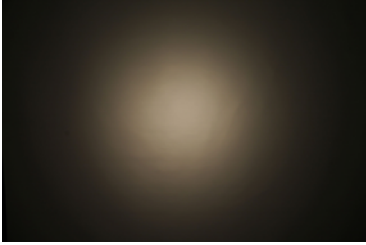
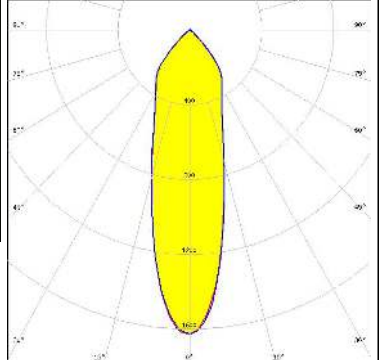
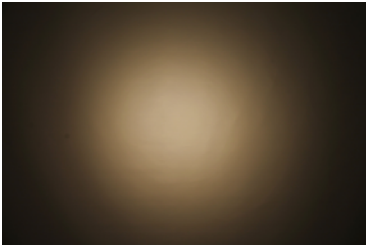
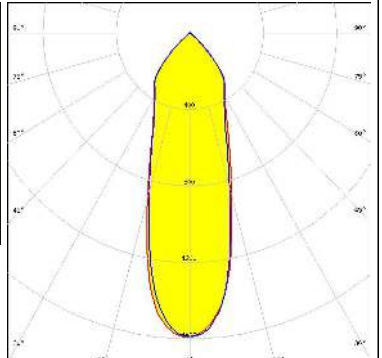

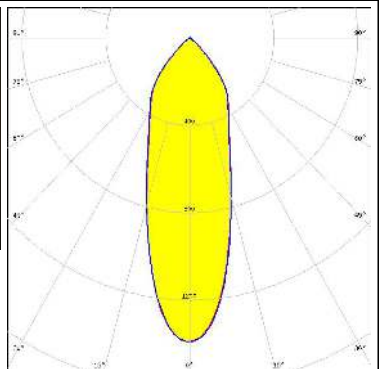
OPTICAL RESULTS (MEASURED):

<p>LUMILEDS</p> <p>LED LUXEON CX Plus CoB - HD S01H4</p> <p>FWHM / FWTM 22.0° / 84.0°</p> <p>Efficiency 86 %</p> <p>Peak intensity 2.1 cd/m</p> <p>LEDs/each optic 1</p> <p>Light colour White</p> <p>Required components: C14658_BARBARA-RZ-LENS Bender Wirth: 634c Hekla</p>		
<p>LUMILEDS</p> <p>LED LUXEON CX Plus CoB - HD S01H4</p> <p>FWHM / FWTM 18.0° / 81.0°</p> <p>Efficiency 93 %</p> <p>Peak intensity 3 cd/m</p> <p>LEDs/each optic 1</p> <p>Light colour White</p> <p>Required components: Bender Wirth: 634c Hekla</p>		
<p>LUMILEDS</p> <p>LED LUXEON CX Plus CoB - HD S02H6</p> <p>FWHM / FWTM 18.0° / 84.0°</p> <p>Efficiency 93 %</p> <p>Peak intensity 2.8 cd/m</p> <p>LEDs/each optic 1</p> <p>Light colour White</p> <p>Required components: Bender Wirth: 634c Hekla</p>		
<p>LUMILEDS</p> <p>LED LUXEON CX Plus CoB - HD S02H6</p> <p>FWHM / FWTM 23.0° / 84.0°</p> <p>Efficiency 86 %</p> <p>Peak intensity 2 cd/m</p> <p>LEDs/each optic 1</p> <p>Light colour White</p> <p>Required components: C14658_BARBARA-RZ-LENS Bender Wirth: 634c Hekla</p>		

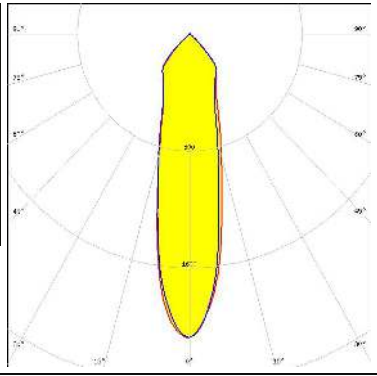

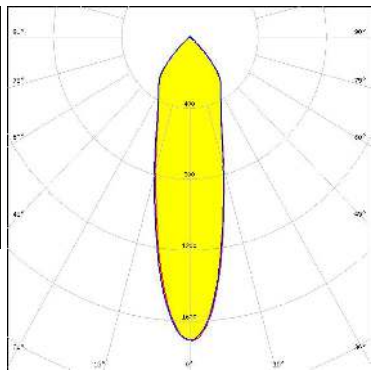
OPTICAL RESULTS (MEASURED):

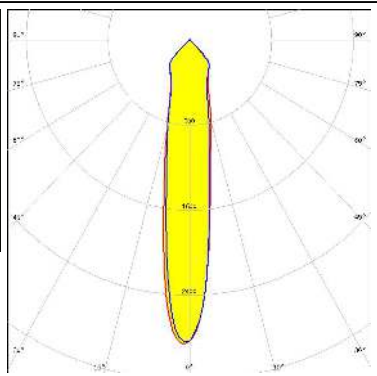
<p>LUMILEDS</p> <p>LED LUXEON CX Plus CoB - HD S04H9</p> <p>FWHM / FWTM 26.0° / 88.0°</p> <p>Efficiency 93 %</p> <p>Peak intensity 1.9 cd/m</p> <p>LEDs/each optic 1</p> <p>Light colour White</p> <p>Required components: Bender Wirth: 634c Hekla</p>		
<p>LUMILEDS</p> <p>LED LUXEON CX Plus CoB - HD S04H9</p> <p>FWHM / FWTM 29.0° / 87.0°</p> <p>Efficiency 86 %</p> <p>Peak intensity 1.6 cd/m</p> <p>LEDs/each optic 1</p> <p>Light colour White</p> <p>Required components: C14658_BARBARA-RZ-LENS Bender Wirth: 634c Hekla</p>		
<p>LUMILEDS</p> <p>LED LUXEON CX Plus CoB L04 / L05 (Gen2)</p> <p>FWHM / FWTM 33.0° / 89.0°</p> <p>Efficiency 92 %</p> <p>Peak intensity 1.6 cd/m</p> <p>LEDs/each optic 1</p> <p>Light colour White</p> <p>Required components: Bender Wirth: 637a Hekla</p>		
<p>LUMILEDS</p> <p>LED LUXEON CX Plus CoB L04 / L05 (Gen2)</p> <p>FWHM / FWTM 34.0° / 89.0°</p> <p>Efficiency 85 %</p> <p>Peak intensity 1.4 cd/m</p> <p>LEDs/each optic 1</p> <p>Light colour White</p> <p>Required components: C14658_BARBARA-RZ-LENS Bender Wirth: 637a Hekla</p>		

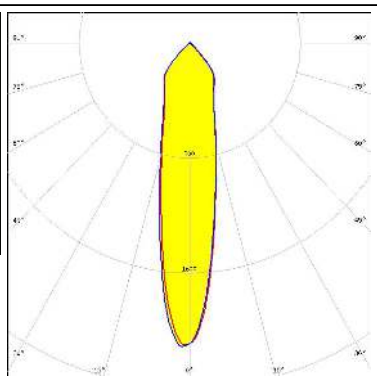

OPTICAL RESULTS (MEASURED):

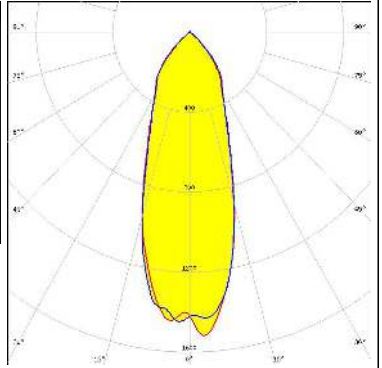
<p>LUMILEDS</p> <p>LED LUXEON CX Plus CoB M02 / M03 (Gen2)</p> <p>FWHM / FWTM 25.0° / 86.0°</p> <p>Efficiency 92 %</p> <p>Peak intensity 2.1 cd/m</p> <p>LEDs/each optic 1</p> <p>Light colour White</p> <p>Required components: Bender Wirth: 641a Hekla</p>		
<p>LUMILEDS</p> <p>LED LUXEON CX Plus CoB M02 / M03 (Gen2)</p> <p>FWHM / FWTM 27.0° / 86.0°</p> <p>Efficiency 86 %</p> <p>Peak intensity 1.7 cd/m</p> <p>LEDs/each optic 1</p> <p>Light colour White</p> <p>Required components: C14658_BARBARA-RZ-LENS Bender Wirth: 641a Hekla</p>		
<p>LUMILEDS</p> <p>LED LUXEON CX Plus CoB S01 (Gen2)</p> <p>FWHM / FWTM 17.0° / 83.0°</p> <p>Efficiency 93 %</p> <p>Peak intensity 2.9 cd/m</p> <p>LEDs/each optic 1</p> <p>Light colour White</p> <p>Required components: Bender Wirth: 634c Hekla</p>		
<p>LUMILEDS</p> <p>LED LUXEON CX Plus CoB S01 (Gen2)</p> <p>FWHM / FWTM 22.0° / 84.0°</p> <p>Efficiency 86 %</p> <p>Peak intensity 2.1 cd/m</p> <p>LEDs/each optic 1</p> <p>Light colour White</p> <p>Required components: C14658_BARBARA-RZ-LENS Bender Wirth: 634c Hekla</p>		

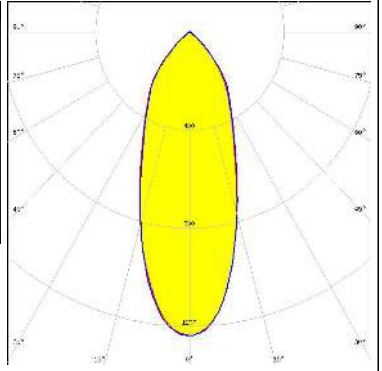
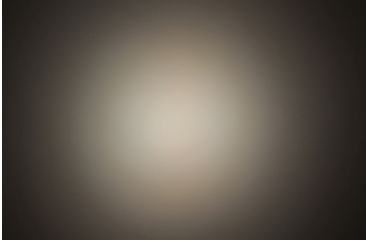
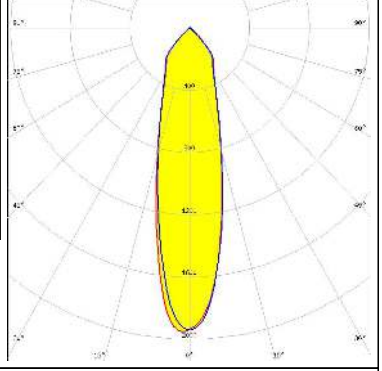
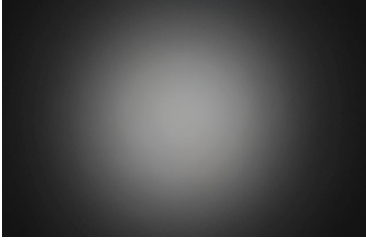
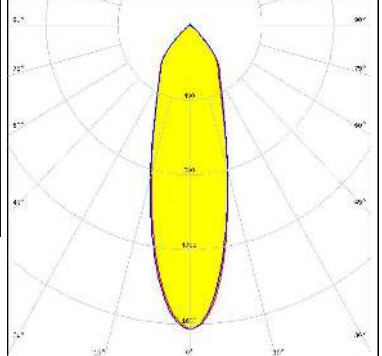

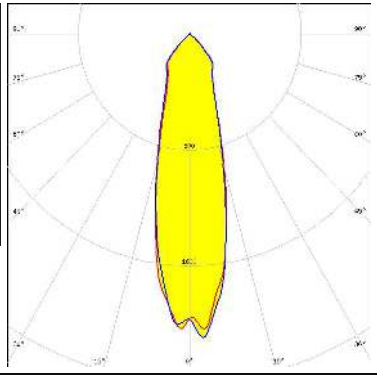
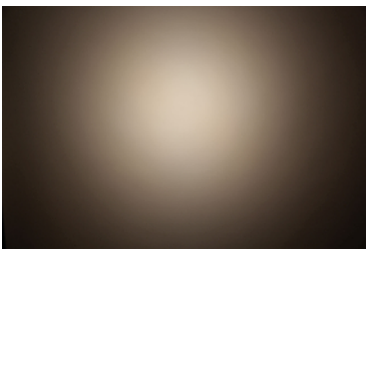
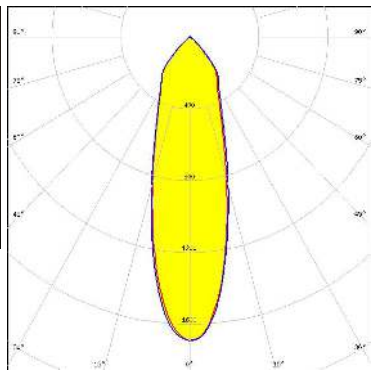

OPTICAL RESULTS (MEASURED):

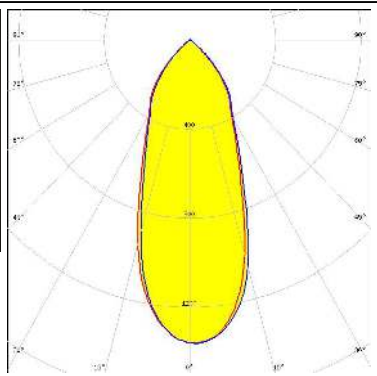
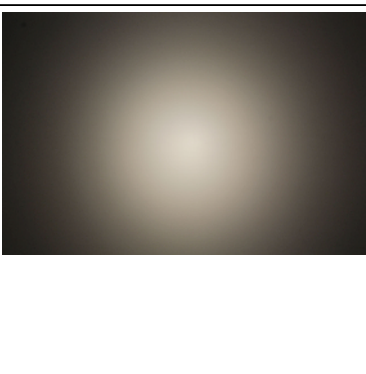
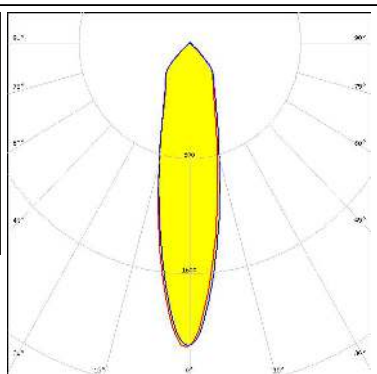
<p>LUMINUS</p> <p>LED CDM-14 (Dim-To-Warm)</p> <p>FWHM / FWTM 36.0° / 87.0°</p> <p>Efficiency 87 %</p> <p>Peak intensity 1.5 cd/lm</p> <p>LEDs/each optic 1</p> <p>Light colour White</p> <p>Required components: C16142_HEKLA-SOCKET-K Bender Wirth: 491 Typ L8</p>		
<p>LUMINUS</p> <p>LED CDM-14 (Dim-To-Warm)</p> <p>FWHM / FWTM 38.0° / 89.0°</p> <p>Efficiency 82 %</p> <p>Peak intensity 1.2 cd/lm</p> <p>LEDs/each optic 1</p> <p>Light colour White</p> <p>Required components: C16142_HEKLA-SOCKET-K C14658_BARBARA-RZ-LENS Bender Wirth: 491 Typ L8</p>		
<p>LUMINUS</p> <p>LED CDM-6 (Dim-To-Warm)</p> <p>FWHM / FWTM 26.0° / 84.0°</p> <p>Efficiency 85 %</p> <p>Peak intensity 2 cd/lm</p> <p>LEDs/each optic 1</p> <p>Light colour White</p> <p>Required components: C16142_HEKLA-SOCKET-K C14658_BARBARA-RZ-LENS Bender Wirth: 490 Typ L8</p>		
<p>LUMINUS</p> <p>LED CDM-9 (Dim-To-Warm)</p> <p>FWHM / FWTM 30.0° / 86.0°</p> <p>Efficiency 84 %</p> <p>Peak intensity 1.6 cd/lm</p> <p>LEDs/each optic 1</p> <p>Light colour White</p> <p>Required components: C16142_HEKLA-SOCKET-K C14658_BARBARA-RZ-LENS Bender Wirth: 490 Typ L8</p>		

OPTICAL RESULTS (MEASURED):

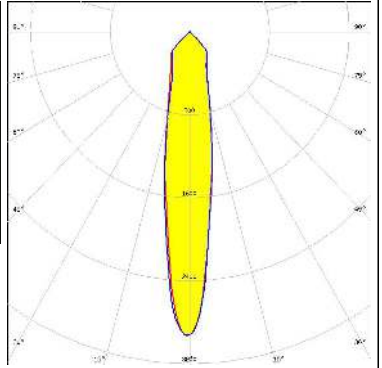
<p>LUMINUS</p> <p>LED CDM-9 (Dim-To-Warm)</p> <p>FWHM / FWTM 28.0° / 84.0°</p> <p>Efficiency 89 %</p> <p>Peak intensity 2.2 cd/m</p> <p>LEDs/each optic 1</p> <p>Light colour White</p> <p>Required components: C16142_HEKLA-SOCKET-K Bender Wirth: 490 Typ L8</p>		
<p>LUMINUS</p> <p>LED CTM-9 (Tunable White)</p> <p>FWHM / FWTM 30.0° / 86.0°</p> <p>Efficiency 85 %</p> <p>Peak intensity 1.7 cd/m</p> <p>LEDs/each optic 1</p> <p>Light colour White</p> <p>Required components: C16142_HEKLA-SOCKET-K C14658_BARBARA-RZ-LENS Bender Wirth: 495 Typ L8</p>		
<p>LUMINUS</p> <p>LED CxM-14 (19x19)</p> <p>FWHM / FWTM 40.0° / 91.0°</p> <p>Efficiency 94 %</p> <p>Peak intensity 1.4 cd/m</p> <p>LEDs/each optic 1</p> <p>Light colour White</p> <p>Required components: F15859_HEKLA-SOCKET-I</p>		
<p>LUMINUS</p> <p>LED CXM-4</p> <p>FWHM / FWTM 24.0° / 85.0°</p> <p>Efficiency 89 %</p> <p>Peak intensity 2.1 cd/m</p> <p>LEDs/each optic 1</p> <p>Light colour White</p> <p>Required components: F15255_HEKLA-SOCKET-C C14658_BARBARA-RZ-LENS</p>		

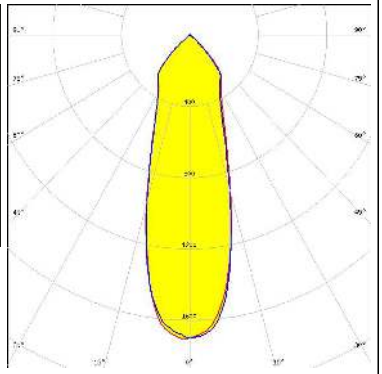
OPTICAL RESULTS (MEASURED):

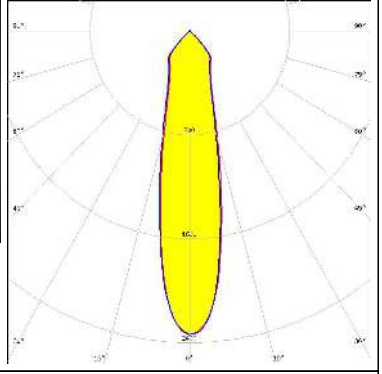
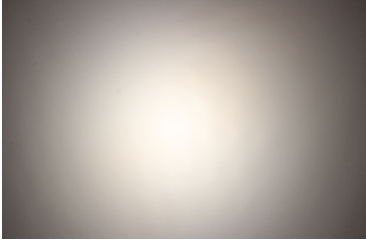
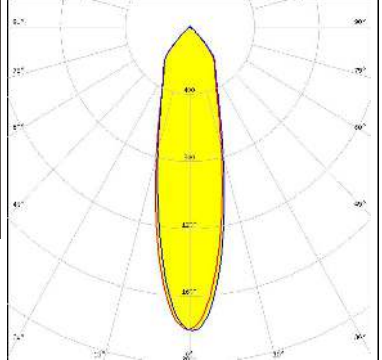
<p>LUMINUS</p> <p>LED CXM-4 FWHM / FWTM 19.0° / 74.0° Efficiency 93 % Peak intensity 2.9 cd/m LEDs/each optic 1 Light colour White Required components: F15255_HEKLA-SOCKET-C</p>		
<p>LUMINUS</p> <p>LED CxM-9 (13.5x13.5) FWHM / FWTM 32.0° / 90.0° Efficiency 94 % Peak intensity 1.7 cd/m LEDs/each optic 1 Light colour White Required components: F15255_HEKLA-SOCKET-C</p>		
<p>NICHIA</p> <p>LED NJCWL024Z-V1MT: COB L-Type Tunable White FWHM / FWTM 24.0° / 82.0° Efficiency 86 % Peak intensity 2.3 cd/m LEDs/each optic 1 Light colour White Required components: C16142_HEKLA-SOCKET-K Bender Wirth: 497 Typ L8</p>		
<p>NICHIA</p> <p>LED NJCWL024Z-V1MT: COB L-Type Tunable White FWHM / FWTM 26.0° / 84.0° Efficiency 81 % Peak intensity 1.8 cd/m LEDs/each optic 1 Light colour White Required components: C16142_HEKLA-SOCKET-K C14658_BARBARA-RZ-LENS Bender Wirth: 497 Typ L8</p>		

OPTICAL RESULTS (MEASURED):

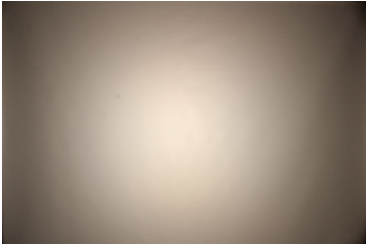
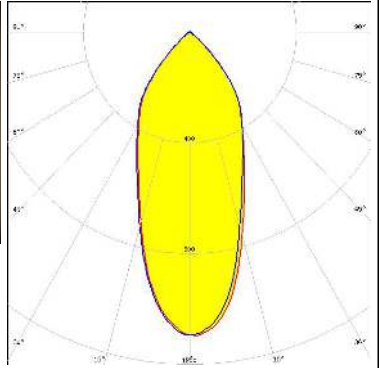
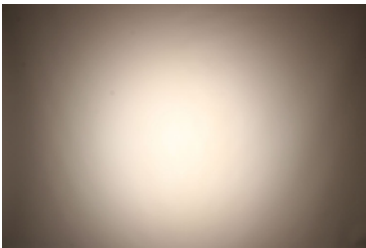
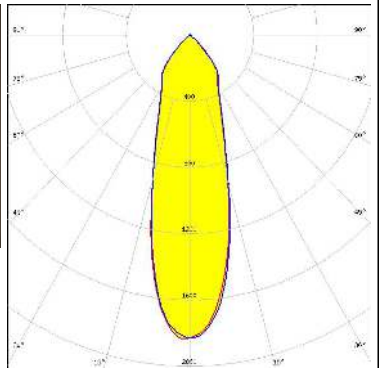
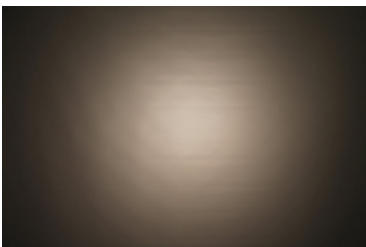
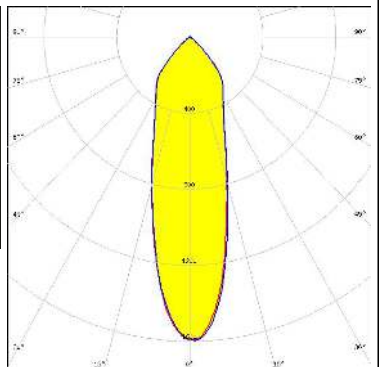
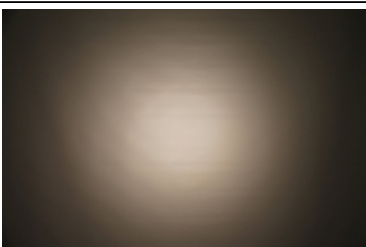
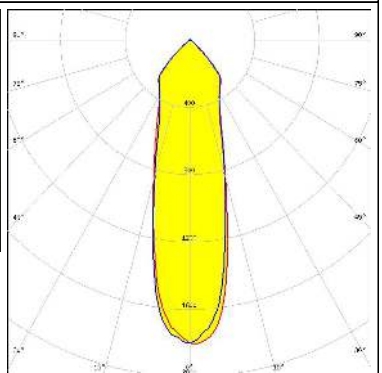
<p>NICHIA</p> <p>LED NVCWJ024Z-V1MT: COB J-Type Tunable White</p> <p>FWHM / FWTM 43.0° / 92.0°</p> <p>Efficiency 84 %</p> <p>Peak intensity 1.1 cd/m</p> <p>LEDs/each optic 1</p> <p>Light colour White</p> <p>Required components: C16142_HEKLA-SOCKET-K C14658_BARBARA-RZ-LENS Bender Wirth: 498 Typ L8</p>		
<p>NICHIA</p> <p>LED NVCWJ024Z-V1MT: COB J-Type Tunable White</p> <p>FWHM / FWTM 30.0° / 84.0°</p> <p>Efficiency 90 %</p> <p>Peak intensity 1.8 cd/m</p> <p>LEDs/each optic 1</p> <p>Light colour White</p> <p>Required components: C16142_HEKLA-SOCKET-K Bender Wirth: 498 Typ L8</p>		
<p>PHILIPS</p> <p>LED Fortimo SLM L09 CoB</p> <p>FWHM / FWTM 30.0° / 89.0°</p> <p>Efficiency 88 %</p> <p>Peak intensity 1.6 cd/m</p> <p>LEDs/each optic 1</p> <p>Light colour White</p> <p>Required components: F15858_HEKLA-SOCKET-H C14658_BARBARA-RZ-LENS</p>		
<p>PHILIPS</p> <p>LED Fortimo SLM L09 CoB</p> <p>FWHM / FWTM 28.0° / 89.0°</p> <p>Efficiency %</p> <p>Peak intensity 1.8 cd/m</p> <p>LEDs/each optic 1</p> <p>Light colour White</p> <p>Required components: F15858_HEKLA-SOCKET-H</p>		

OPTICAL RESULTS (MEASURED):

PHILIPS

LED Fortimo SLM L13 CoB
 FWHM / FWTM 39.0° / 90.0°
 Efficiency 84 %
 Peak intensity 1.2 cd/lm
 LEDs/each optic 1
 Light colour White
 Required components:
 C16142_HEKLA-SOCKET-K
 C14658_BARBARA-RZ-LENS
 Bender Wirth: 432 Typ L8

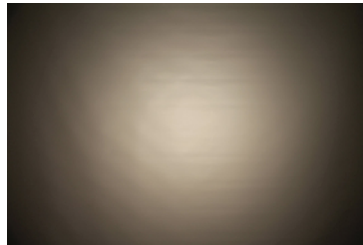

PHILIPS

LED Fortimo SLM L13 CoB
 FWHM / FWTM 36.0° / 89.0°
 Efficiency 89 %
 Peak intensity 1.4 cd/lm
 LEDs/each optic 1
 Light colour White
 Required components:
 C16142_HEKLA-SOCKET-K
 Bender Wirth: 432 Typ L8

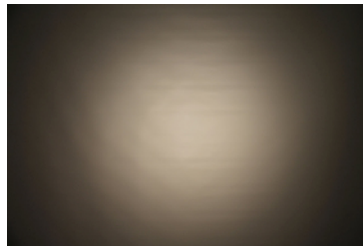

SAMSUNG

LED LC003D / LC006D / LC009D / LC013D
 FWHM / FWTM 28.0° / 87.0°
 Efficiency 94 %
 Peak intensity 2 cd/lm
 LEDs/each optic 1
 Light colour White
 Required components:
 F15255_HEKLA-SOCKET-C

SAMSUNG

LED LC003D / LC006D / LC009D / LC013D
 FWHM / FWTM 28.0° / 87.0°
 Efficiency 94 %
 Peak intensity 2 cd/lm
 LEDs/each optic 1
 Light colour White
 Required components:
 F15255_HEKLA-SOCKET-C

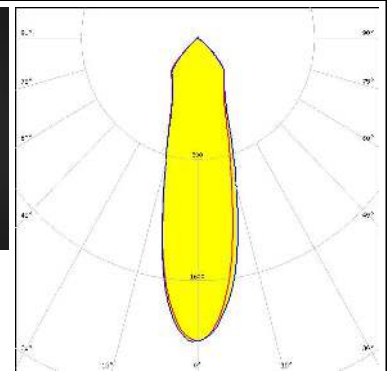

OPTICAL RESULTS (MEASURED):

SAMSUNG

LED LC010C G2
 FWHM / FWTM 23.0° / 86.0°
 Efficiency 93 %
 Peak intensity 2.4 cd/m
 LEDs/each optic 1
 Light colour White
 Required components:
 F15255_HEKLA-SOCKET-C

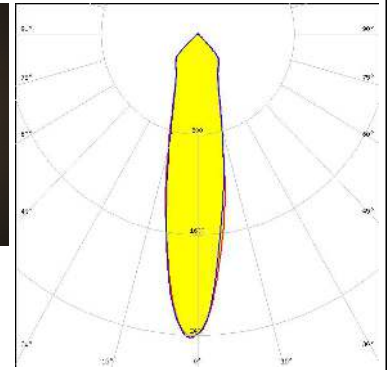
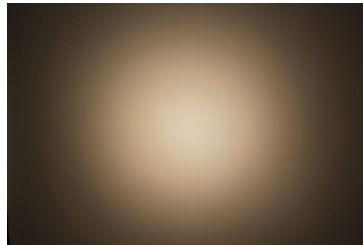

SAMSUNG

LED LC010T (Tunable White)
 FWHM / FWTM 27.0° / 84.0°
 Efficiency 90 %
 Peak intensity 2.1 cd/m
 LEDs/each optic 1
 Light colour Tunable White
 Required components:
 C16142_HEKLA-SOCKET-K
 Bender Wirth: 501 Typ L8

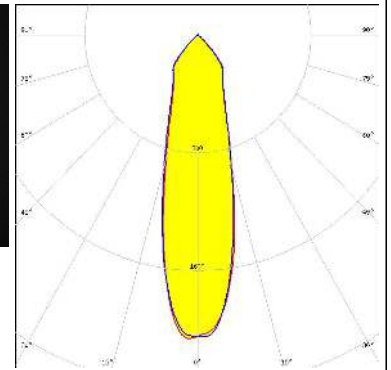

SAMSUNG

LED LC010T (Tunable White)
 FWHM / FWTM 30.0° / 85.0°
 Efficiency 86 %
 Peak intensity 1.7 cd/m
 LEDs/each optic 1
 Light colour Tunable White
 Required components:
 C16142_HEKLA-SOCKET-K
 C14658_BARBARA-RZ-LENS
 Bender Wirth: 501 Typ L8

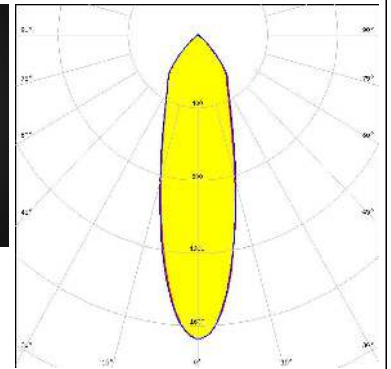
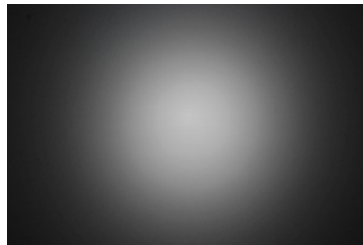

SAMSUNG

LED LC020C G2
 FWHM / FWTM 31.0° / 88.0°
 Efficiency 94 %
 Peak intensity 1.8 cd/m
 LEDs/each optic 1
 Light colour White
 Required components:
 F15859_HEKLA-SOCKET-I

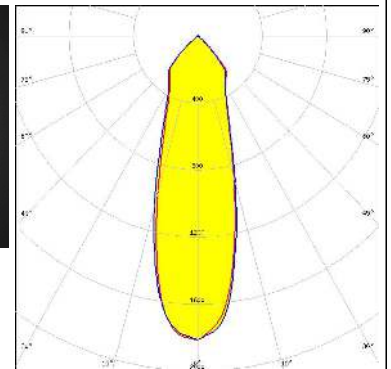
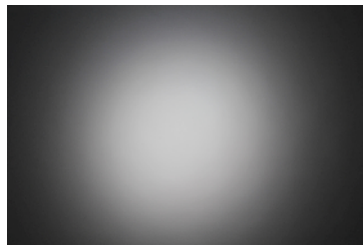

OPTICAL RESULTS (MEASURED):

SAMSUNG

LED LC020T (Tunable white)
 FWHM / FWTM 36.0° / 87.0°
 Efficiency 90 %
 Peak intensity 1.5 cd/m
 LEDs/each optic 1
 Light colour Tunable White
 Required components:
 C16142_HEKLA-SOCKET-K
 Bender Wirth: 501 Typ L8

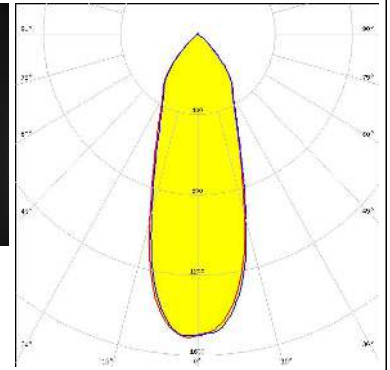

SAMSUNG

LED LC020T (Tunable white)
 FWHM / FWTM 38.0° / 86.0°
 Efficiency 85 %
 Peak intensity 1.3 cd/m
 LEDs/each optic 1
 Light colour Tunable White
 Required components:
 C16142_HEKLA-SOCKET-K
 C14658_BARBARA-RZ-LENS
 Bender Wirth: 501 Typ L8

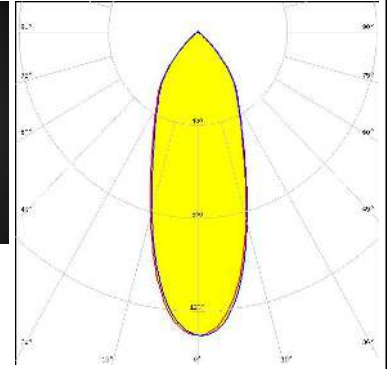

SEOUL SEMICONDUCTOR
 LED MJT COB LES 6
 FWHM / FWTM 20.0° / 82.0°
 Efficiency 93 %
 Peak intensity 2.7 cd/m
 LEDs/each optic 1
 Light colour White
 Required components:
 F15255_HEKLA-SOCKET-C

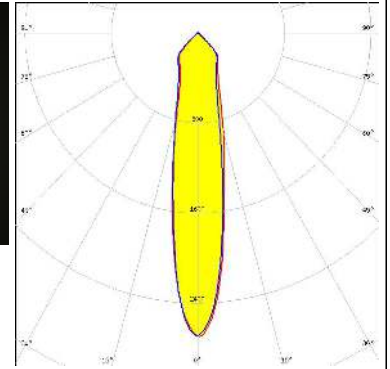

SEOUL SEMICONDUCTOR
 LED MJT COB LES 9.8
 FWHM / FWTM 31.0° / 89.0°
 Efficiency 93 %
 Peak intensity 1.8 cd/m
 LEDs/each optic 1
 Light colour White
 Required components:
 F15255_HEKLA-SOCKET-C

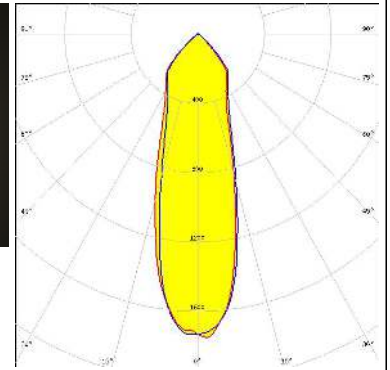
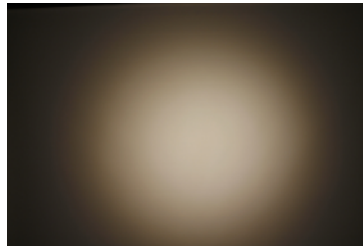

OPTICAL RESULTS (MEASURED):

TRIDONIC

LED SLE G7 LES09
 FWHM / FWTM 31.0° / 89.0°
 Efficiency 94 %
 Peak intensity 1.8 cd/lm
 LEDs/each optic 1
 Light colour White
 Required components:
 F15255_HEKLA-SOCKET-C

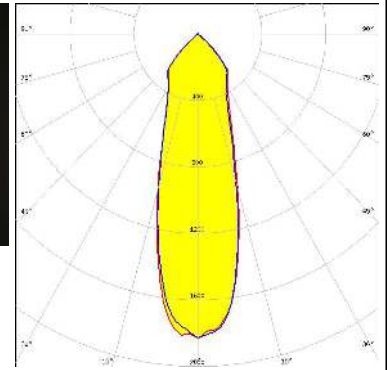

TRIDONIC

LED SLE G7 LES09
 FWHM / FWTM 30.0° / 87.0°
 Efficiency 91 %
 Peak intensity 1.7 cd/lm
 LEDs/each optic 1
 Light colour White
 Required components:
 F15255_HEKLA-SOCKET-C
 C14658_BARBARA-RZ-LENS

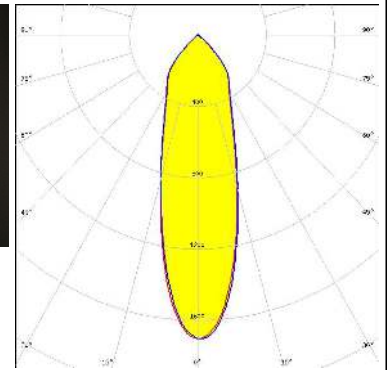
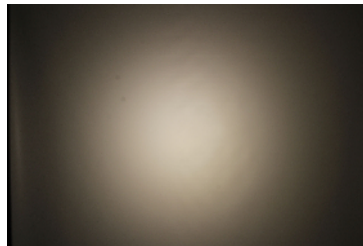

TRIDONIC

LED SLE G7 LES13
 FWHM / FWTM 39.0° / 91.0°
 Efficiency 93 %
 Peak intensity 1.4 cd/lm
 LEDs/each optic 1
 Light colour White
 Required components:
 F15859_HEKLA-SOCKET-I

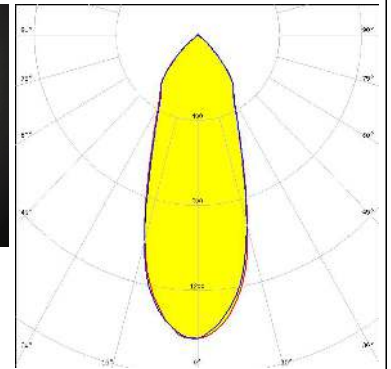
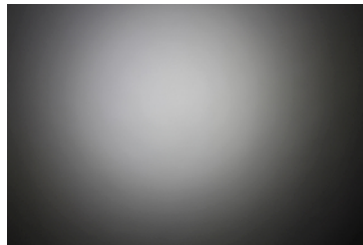

TRIDONIC

LED SLE G7 LES13
 FWHM / FWTM 38.0° / 91.0°
 Efficiency 93 %
 Peak intensity 1.4 cd/lm
 LEDs/each optic 1
 Light colour White
 Required components:
 F15859_HEKLA-SOCKET-I

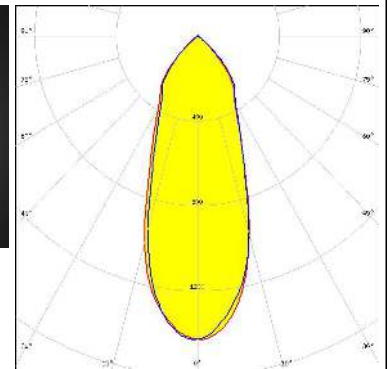
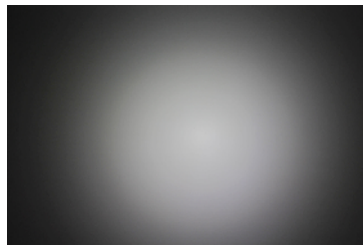

OPTICAL RESULTS (MEASURED):

TRIDONIC

LED SLE G7 LES13
 FWHM / FWTM 39.0° / 91.0°
 Efficiency 87 %
 Peak intensity 1.3 cd/m
 LEDs/each optic 1
 Light colour White
 Required components:
 F15859_HEKLA-SOCKET-I
 C14658_BARBARA-RZ-LENS

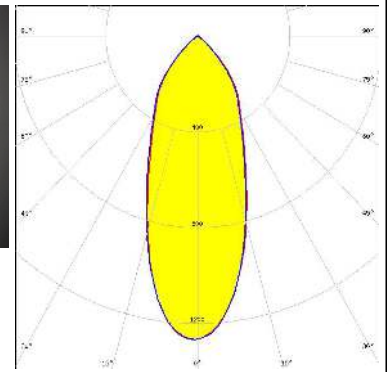

TRIDONIC

LED SLE G7 LES13
 FWHM / FWTM 40.0° / 90.0°
 Efficiency 86 %
 Peak intensity 1.3 cd/m
 LEDs/each optic 1
 Light colour White
 Required components:
 F15859_HEKLA-SOCKET-I
 C14658_BARBARA-RZ-LENS

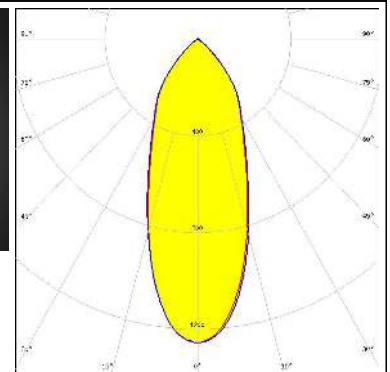
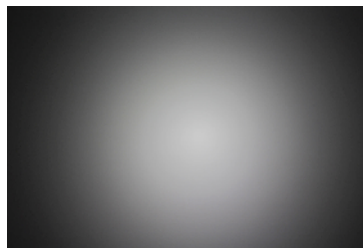

TRIDONIC

LED SLE G7 LES15
 FWHM / FWTM 42.0° / 92.0°
 Efficiency 94 %
 Peak intensity 1.3 cd/m
 LEDs/each optic 1
 Light colour White
 Required components:
 F15859_HEKLA-SOCKET-I

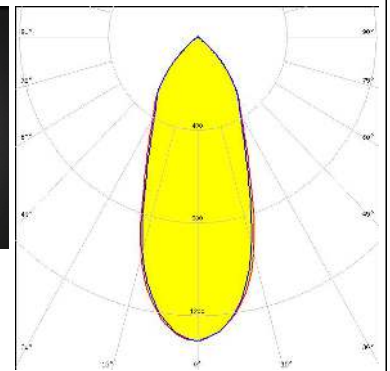
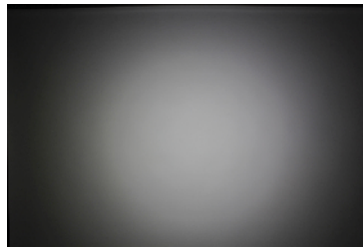

XICATO

LED XOB 14.5 mm
 FWHM / FWTM 42.0° / 92.0°
 Efficiency 94 %
 Peak intensity 1.3 cd/m
 LEDs/each optic 1
 Light colour White
 Required components:
 F15859_HEKLA-SOCKET-I

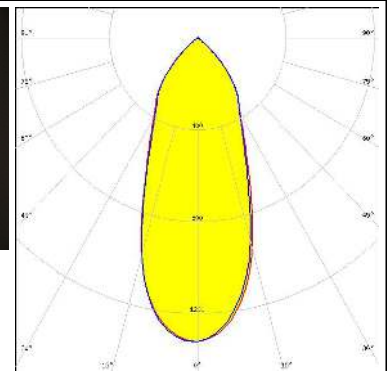
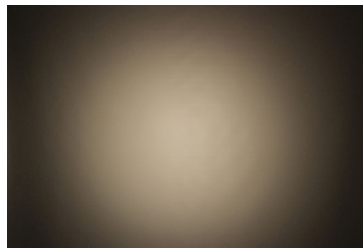

OPTICAL RESULTS (MEASURED):

XICATO

LED XOB 6 mm
 FWHM / FWTM 27.0° / 86.0°
 Efficiency 88 %
 Peak intensity 1.9 cd/lm
 LEDs/each optic 1
 Light colour White
 Required components:
 F15255_HEKLA-SOCKET-C
 C14658_BARBARA-RZ-LENS

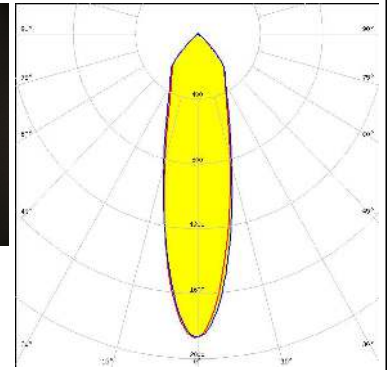
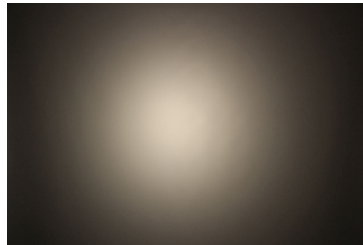

XICATO

LED XOB 6 mm
 FWHM / FWTM 25.0° / 87.0°
 Efficiency 94 %
 Peak intensity 2.3 cd/lm
 LEDs/each optic 1
 Light colour White
 Required components:
 F15255_HEKLA-SOCKET-C

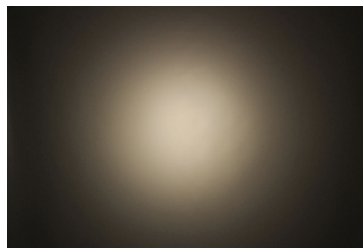

XICATO

LED XOB 9.8 mm
 FWHM / FWTM 32.0° / 89.0°
 Efficiency 89 %
 Peak intensity 1.6 cd/lm
 LEDs/each optic 1
 Light colour White
 Required components:
 F15255_HEKLA-SOCKET-C
 C14658_BARBARA-RZ-LENS

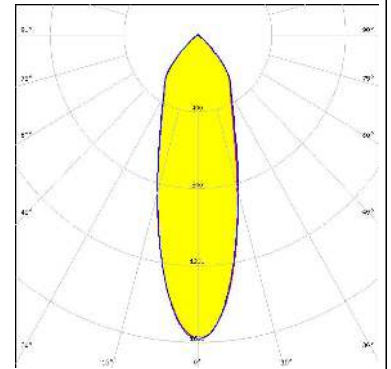

XICATO

LED XOB 9.8 mm
 FWHM / FWTM 32.0° / 90.0°
 Efficiency 94 %
 Peak intensity 1.7 cd/lm
 LEDs/each optic 1
 Light colour White
 Required components:
 F15255_HEKLA-SOCKET-C

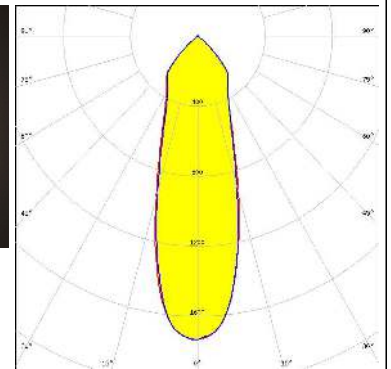
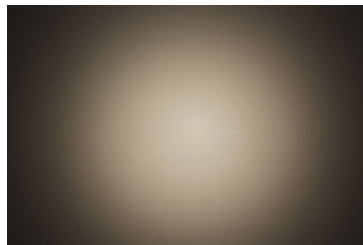

OPTICAL RESULTS (MEASURED):

XICATO

LED XTM - 19mm LES
FWHM / FWTM 48.0° / 95.0°
Efficiency 91 %
Peak intensity 1.1 cd/lm
LEDs/each optic 1
Light colour White
Required components:
C15743_XTM-ADAPTER-50-B

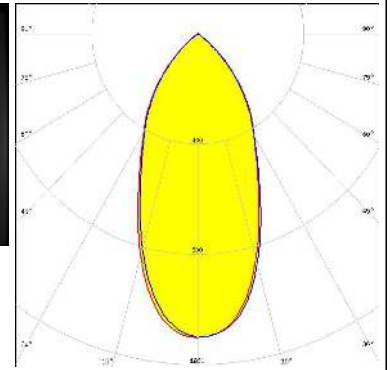



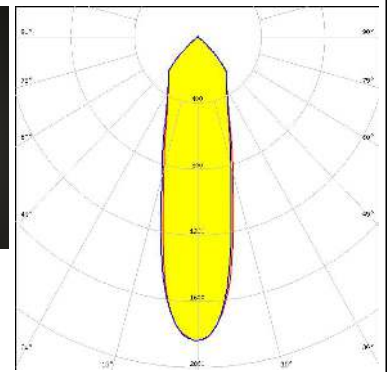
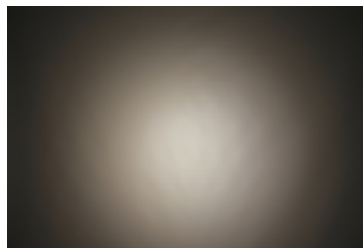

XICATO

LED XTM - 9mm LES
FWHM / FWTM 28.0° / 90.0°
Efficiency 94 %
Peak intensity 1.8 cd/lm
LEDs/each optic 1
Light colour White
Required components:
C15743_XTM-ADAPTER-50-B

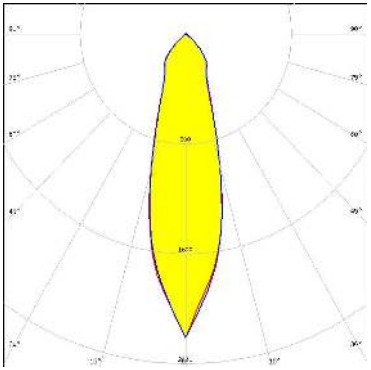

OPTICAL RESULTS (SIMULATED):

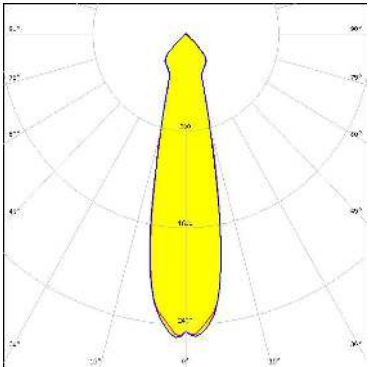
 LED V13 Gen6 FWHM / FWTM 28.0° / 80.0° Efficiency 91 % Peak intensity 2.2 cd/lm LEDs/each optic 1 Light colour White Required components: F14988_HEKLA-SOCKET-E	
 LED V8 Gen6 FWHM / FWTM 25.0° Efficiency 0 % LEDs/each optic 1 Light colour White Required components: F15253_HEKLA-SOCKET-A	
 LED V8 Gen6 FWHM / FWTM 25.0° Efficiency % LEDs/each optic 1 Light colour White Required components: F15253_HEKLA-SOCKET-A	
 LED V8 Gen7 FWHM / FWTM 24.0° / 83.0° Efficiency 92 % Peak intensity 2.5 cd/lm LEDs/each optic 1 Light colour White Required components: F15253_HEKLA-SOCKET-A	

OPTICAL RESULTS (SIMULATED):

bridgelux.

LED	Vesta TW 9mm (9W) DP
FWHM / FWTM	28.0° / 84.0°
Efficiency	87 %
Peak intensity	2 cd/lm
LEDs/each optic	1
Light colour	White

Required components:
 C16142_HEKLA-SOCKET-K
 C14658_BARBARA-RZ-LENS
 Bender Wirth: 489 Typ L8



CITIZEN

LED	CLL02x/CLU02x (LES10)
FWHM / FWTM	26.0° / 78.0°
Efficiency	%
LEDs/each optic	1
Light colour	White

Required components:
 F15255_HEKLA-SOCKET-C

CITIZEN

LED	CLL02x/CLU02x (LES10)
FWHM / FWTM	26.0° / 81.0°
Efficiency	92 %
Peak intensity	2.5 cd/lm
LEDs/each optic	1
Light colour	White

Required components:
 F15255_HEKLA-SOCKET-C

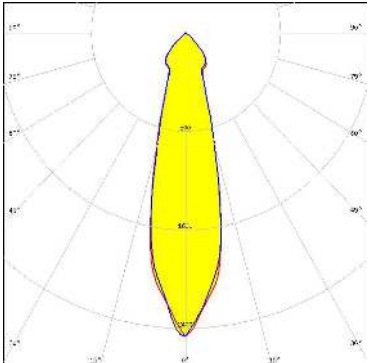

CITIZEN

LED	CLL02x/CLU02x (LES10)
FWHM / FWTM	26.0°
Efficiency	0 %
LEDs/each optic	1
Light colour	White

Required components:
 F15255_HEKLA-SOCKET-C

OPTICAL RESULTS (SIMULATED):

CITIZEN

LED CLL03x/CLU03x
 FWHM / FWTM 36.0° / 87.0°
 Efficiency 93 %
 Peak intensity 1.6 cd/lm
 LEDs/each optic 1
 Light colour White
 Required components:
 F15859_HEKLA-SOCKET-I

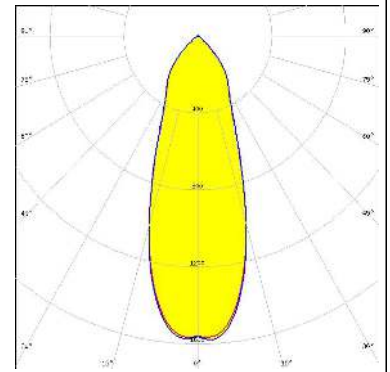

LED CxA/B 1816 & CxA/B 1820 & CxA 1850
 FWHM / FWTM 31.0°
 Efficiency 0 %
 LEDs/each optic 1
 Light colour White
 Required components:
 F15254_HEKLA-SOCKET-B



LED CxA/B 1816 & CxA/B 1820 & CxA 1850
 FWHM / FWTM 31.0°
 Efficiency %
 LEDs/each optic 1
 Light colour White
 Required components:
 F15254_HEKLA-SOCKET-B



LED CxM-6 (13.5x13.5)
 FWHM / FWTM 22.0° / 56.0°
 Efficiency 93 %
 Peak intensity 3.1 cd/lm
 LEDs/each optic 1
 Light colour White
 Required components:
 F17435_HEKLA-G2-C

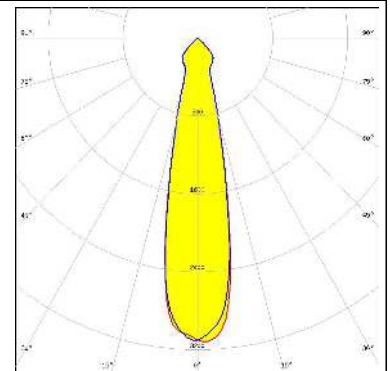

OPTICAL RESULTS (SIMULATED):

<p>NICHIA</p> <p>LED COB L-Type (LES 11)</p> <p>FWHM / FWTM 28.0° / 82.0°</p> <p>Efficiency 93 %</p> <p>Peak intensity 2.2 cd/lm</p> <p>LEDs/each optic 1</p> <p>Light colour White</p> <p>Required components: F15858_HEKLA-SOCKET-H</p>	
<p>NICHIA</p> <p>LED COB L-Type (LES 9)</p> <p>FWHM / FWTM 26.0° / 80.0°</p> <p>Efficiency 93 %</p> <p>Peak intensity 2.5 cd/lm</p> <p>LEDs/each optic 1</p> <p>Light colour White</p> <p>Required components: F15858_HEKLA-SOCKET-H</p>	
<p>NICHIA</p> <p>LED COB T-Type</p> <p>FWHM / FWTM 24.0° / 77.0°</p> <p>Efficiency 90 %</p> <p>Peak intensity 2.7 cd/lm</p> <p>LEDs/each optic 1</p> <p>Light colour White</p> <p>Required components: F15848_HEKLA-SOCKET-G</p>	
<p>NICHIA</p> <p>LED NFSWE11A</p> <p>FWHM / FWTM 24.0° / 64.0°</p> <p>Efficiency 86 %</p> <p>Peak intensity 2.6 cd/lm</p> <p>LEDs/each optic 30</p> <p>Light colour White</p> <p>Required components: C16142_HEKLA-SOCKET-K</p>	

OPTICAL RESULTS (SIMULATED):

<p>OSRAM Opto Semiconductors</p> <p>LED Soleriq S13 19x19</p> <p>FWHM / FWTM 28.2° / 81.4°</p> <p>Efficiency 93 %</p> <p>Peak intensity 2.2 cd/lm</p> <p>LEDs/each optic 1</p> <p>Light colour White</p> <p>Required components: F15859_HEKLA-SOCKET-I</p>	
<p>OSRAM Opto Semiconductors</p> <p>LED Soleriq S9</p> <p>FWHM / FWTM 25.7° / 80.8°</p> <p>Efficiency 93 %</p> <p>Peak intensity 2.5 cd/lm</p> <p>LEDs/each optic 1</p> <p>Light colour White</p> <p>Required components: F15255_HEKLA-SOCKET-C</p>	
<p>SAMSUNG</p> <p>LED LC016D / LC019D / LC026D / LC033D</p> <p>FWHM / FWTM 35.0° / 86.5°</p> <p>Efficiency 88 %</p> <p>Peak intensity 1.6 cd/lm</p> <p>LEDs/each optic 1</p> <p>Light colour White</p> <p>Required components: F15859_HEKLA-SOCKET-I</p>	

GENERAL INFORMATION:

NOTE: The typical beam angle will be changed by different color, chip size and chip position tolerance. The typical total beam angle is the full angle measured where the luminous intensity is half of the peak value.

Due to use of high power COB's with this product, special attention to proper thermal design is highly recommended. LEDiL has no liability for direct, indirect or consecutive damages arising from the LEDiL products being used outside of the recommended temperature range.

MATERIALS:

As part of our continuous research and improvement processes, and to ensure the best possible quality and availability of our products, LEDiL reserves the right to change material grades without notice.

PRODUCT DATA USER AGREEMENT AND DISCLAIMER:

The measured data in the provided downloadable LEDiL Product Datasheets and Mechanical 2D-Drawings is rounded and provided as reference for planning. LEDiL Oy's optical specifications have been verified by conducting performance testing of the products in accordance with the company's quality system. The reported data are averaged results of multiple measurements with typical variation. LEDiL Oy reserves the right to without prior notification make changes and improvements to its products.

LEDiL Oy assumes neither warranty, nor guarantee nor any other liability of any kind for the contents and correctness of the provided data. The provided data has been generated with highest diligence but the provided data may in reality not represent the complete possible variation range of all intrinsic parameters. Therefore, in certain cases a deviation from the provided data could occur.

LEDiL Oy reserves the right to undertake technical changes of its products without further notification which could lead to changes in the provided data. LEDiL Oy assumes no liability of any kind for the possible deviation from any provided data or any other damage resulting from the usage of the provided data.

The user agrees to this disclaimer and user agreement with the download or usage of the provided files.

LEDiL Oy

Joensuunkatu 13
FI-24240 SALO
Finland

LEDiL Inc.

228 West Page Street
Suite D
Sycamore IL 60178
USA

Ledil Optics Technology (Shenzhen) Co., Ltd.

405 , Block B
Casic Motor Building
Shenzhen 518057
P.R.CHINA

Local sales and technical support

[www.ledil.com/
where_to_buy](http://www.ledil.com/where_to_buy)

Shipping locations

Salo, Finland
Hong Kong, China

Distribution Partners

[www.ledil.com/
where_to_buy](http://www.ledil.com/where_to_buy)