

THIS IS A C.A.D. GENERATED DRAWING
DO NOT MAKE MANUAL REVISIONS TO MASTER.

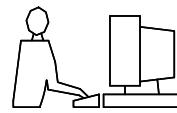

* UNLESS OTHERWISE SPECIFIED TOLERANCES
ON DECIMAL IS: ANGLE $\pm 3^\circ$
UNIT: MM X ± 0.50
X.X ± 0.38
X.XX ± 0.25
X.XXX ± 0.10

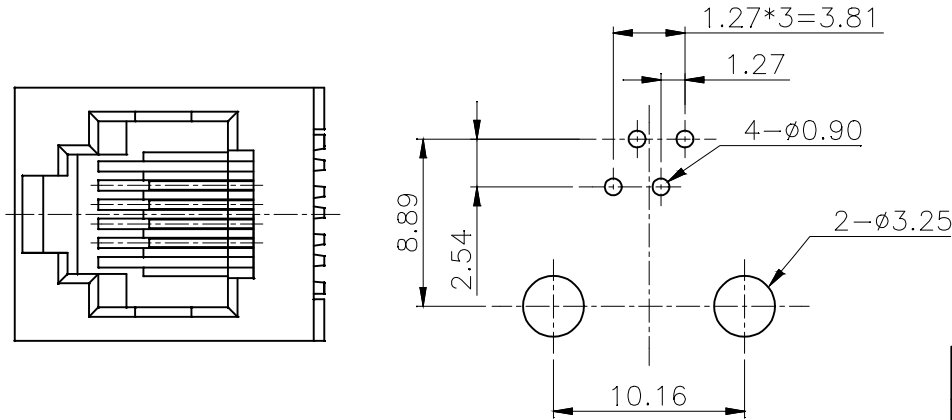

PCB LAYOUT/TOP VIEW

Ordering information:

Type	P/N-BULK	Product Code
6P4C-V-Unshielded	2101-0110-14	MHRJJ64NFV

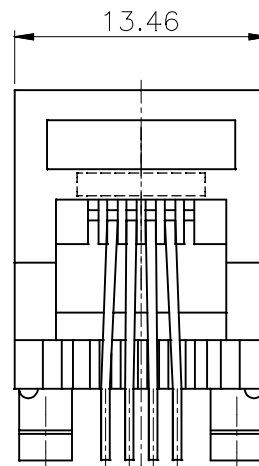
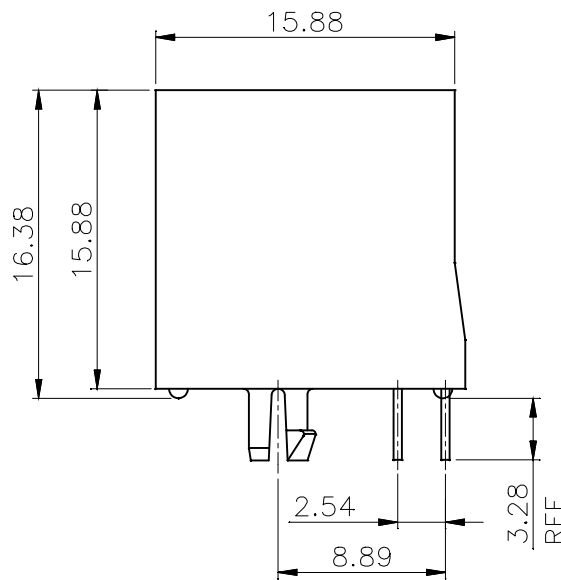

MATERIALS:

1. PLASTIC HOUSING: ENGINEERING THERMOPLASTIC
FLAMMABILITY RATING UL 94V-0.
2. CONTACTS: 0.46MM DIAMETER PHOSPHOR BRONZE.
3. PLATING: GOLD PLATING OVER NICKEL.

THESE DRAWINGS AND SPECIFICATIONS ARE THE PROPERTY OF MH CONNECTORS LTD. AND SHALL NOT BE REPRODUCED, COPIED OR USED AS THE BASIS FOR THE MANUFACTURE OR SALE OF APPARATUS WITHOUT WRITTEN PERMISSION.

DRAWN HALEY		DATE 11-18-13
APPROVED		DATE
SCALE	SHEET OF 1 OF 1	REV: 3.0
DRAWING No MHRJJ64NFV		



THIS SERIES FULLY CONFORMS TO THE EUROPEAN UNION DIRECTIVES 2002/95/EC AND 2002/96/EC FOR RoHS COMPLIANCY.



MH CONNECTORS LTD.