

WL18-3P630S04

W18-3

SMALL PHOTOELECTRIC SENSORS

SICK
Sensor Intelligence.



Illustration may differ

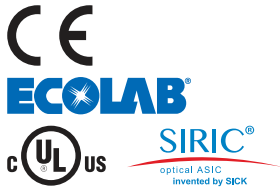

Ordering information

Type	Part no.
WL18-3P630S04	1041928

Other models and accessories → www.sick.com/W18-3

Detailed technical data

Features

Functional principle	Photoelectric retro-reflective sensor
Functional principle detail	Autocollimation
Dimensions (W x H x D)	17.6 mm x 75.5 mm x 33.5 mm
Housing design (light emission)	Rectangular
Sensing range max.	0 m ... 7 m ¹⁾
Sensing range	0 m ... 5 m ¹⁾
Focus	1.8°
Type of light	Visible red light
Light source	LED ²⁾
Light spot size (distance)	Ø 40 mm (2 m)
Angle of dispersion	1.8°
Wave length	645 nm
Adjustment	Potentiometer, 1 turn
Special features	Heightened vibration resistance

¹⁾ Reflector PL80A.

²⁾ Average service life: 100,000 h at T_J = +25 °C.

Mechanics/electronics

Supply voltage	10 V DC ... 30 V DC ¹⁾
Ripple	< 5 V _{pp} ²⁾
Current consumption	40 mA ³⁾
Switching output	PNP
Switching mode	Light/dark switching
Output current I_{max}	≤ 100 mA
Response time	< 500 μs ⁴⁾
Switching frequency	1,000 Hz ⁵⁾
Connection type	Cubic connector, 6-pin
Circuit protection	A ⁶⁾ C ⁷⁾ D ⁸⁾
Weight	70 g
Polarisation filter	✓
Housing material	Plastic, ABS
Optics material	Plastic, PMMA
Enclosure rating	IP65
Test input sender off	TE to 0 V
Test input	✓
Ambient operating temperature	-40 °C ... +60 °C
Ambient temperature, storage	-40 °C ... +75 °C
UL File No.	NRKH.E181493 & NRKH7.E181493

¹⁾ Limit values when operated in short-circuit protected network: max. 8 A.

²⁾ May not exceed or fall below U_v tolerances.

³⁾ Without load.

⁴⁾ Signal transit time with resistive load.

⁵⁾ With light/dark ratio 1:1.

⁶⁾ A = V_S connections reverse-polarity protected.

⁷⁾ C = interference suppression.

⁸⁾ D = outputs overcurrent and short-circuit protected.

Safety-related parameters

MTTF_D	1,759 years
DC_{avg}	0 %

Classifications

eCl@ss 5.0	27270902
eCl@ss 5.1.4	27270902
eCl@ss 6.0	27270902
eCl@ss 6.2	27270902
eCl@ss 7.0	27270902
eCl@ss 8.0	27270902
eCl@ss 8.1	27270902

eCl@ss 9.0	27270902
eCl@ss 10.0	27270902
eCl@ss 11.0	27270902
eCl@ss 12.0	27270902
ETIM 5.0	EC002717
ETIM 6.0	EC002717
ETIM 7.0	EC002717
ETIM 8.0	EC002717
UNSPSC 16.0901	39121528

Connection diagram

Cd-178

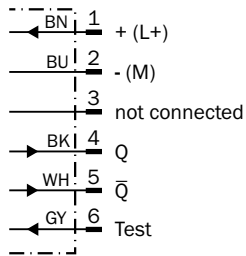

Characteristic curve

WL18-3, WL18-3 Ex

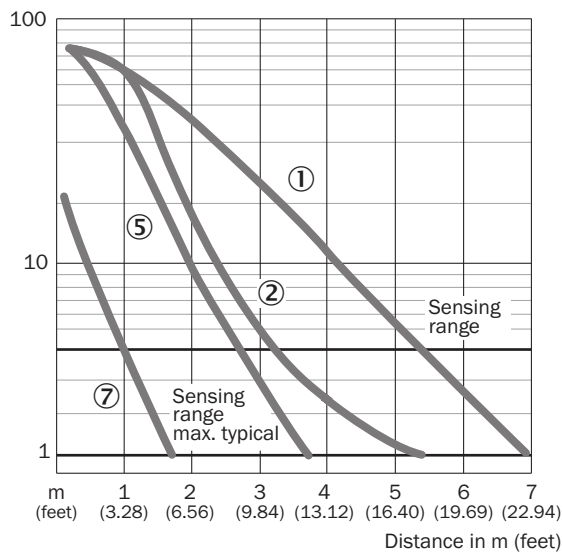

- ① Reflector PL80A
- ② Reflector C110A
- ③ Reflector PL30A
- ④ Reflective tape Diamond Grade

Sensing range diagram

WL18-3, WL18-3 Ex

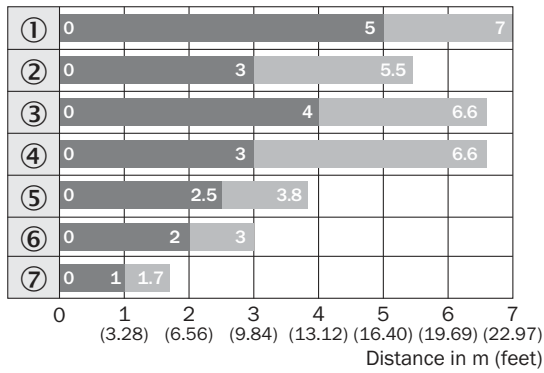

■ Sensing range ■ Sensing range max.

- ① Reflector PL80A
- ② Reflector C110A
- ③ Reflector PL50A
- ④ Reflector PL40A
- ⑤ Reflector PL30A
- ⑥ Reflector PL20A
- ⑦ Reflective tape Diamond Grade

Adjustments

Potentiometer

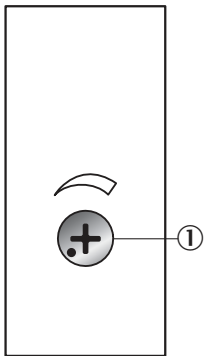

- ① Setting of the sensing range: potentiometer, 4 revolutions

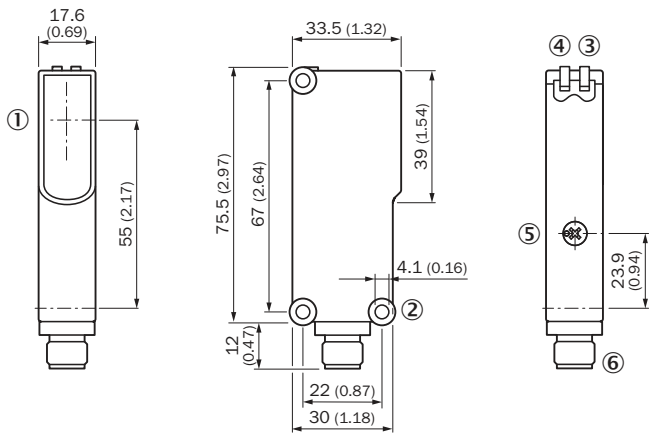

Dimensional drawing (Dimensions in mm (inch))



- ① Center of optical axis
- ② Mounting hole \varnothing 4.1 mm
- ③ LED indicator yellow: Status of received light beam
- ④ LED indicator green: Supply voltage active
- ⑤ Sensitivity control, potentiometer 270° on WE
- ⑥ 4-pin M12 male connector or 2 m cable or 6-pin cubic connector

Recommended accessories

Other models and accessories → www.sick.com/W18-3

	Brief description	Type	Part no.
Mounting brackets and plates			
	Universal mounting bracket for reflectors, steel, zinc coated	BEF-WN-REFX	2064574
Reflectors			
	Rectangular, screw connection, 84 mm x 84 mm, PMMA/ABS, Screw-on, 2 hole mounting	PL80A	1003865

SICK AT A GLANCE

SICK is one of the leading manufacturers of intelligent sensors and sensor solutions for industrial applications. A unique range of products and services creates the perfect basis for controlling processes securely and efficiently, protecting individuals from accidents and preventing damage to the environment.

We have extensive experience in a wide range of industries and understand their processes and requirements. With intelligent sensors, we can deliver exactly what our customers need. In application centers in Europe, Asia and North America, system solutions are tested and optimized in accordance with customer specifications. All this makes us a reliable supplier and development partner.

Comprehensive services complete our offering: SICK LifeTime Services provide support throughout the machine life cycle and ensure safety and productivity.

For us, that is “Sensor Intelligence.”

WORLDWIDE PRESENCE:

Contacts and other locations www.sick.com