

RADIAL LEADS

Ceramam®

GENERAL INFORMATION

MR Series

Molded Radial Leaded MLC

Temperature Coefficients: COG (NP0), X7R, Z5U
50, 100, 200 Volts

Case Material: Molded Epoxy

Lead Material: Solderable

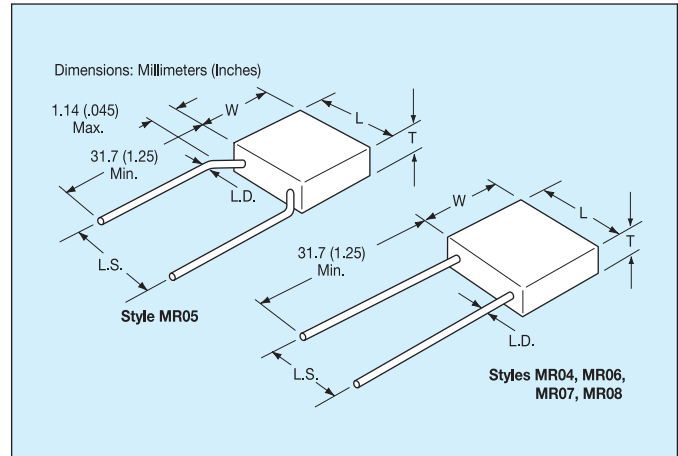

HOW TO ORDER

MR05

1

A

561

J

A

R

Style

MR04
MR05
MR06
MR07
MR08

Voltage

5 = 50V
1 = 100V
2 = 200V

Dielectric

A = COG (NP0)
C = X7R
E = Z5U

Capacitance

First two digits are the significant figures of capacitance. Third digit indicates the additional number of zeros. For example, order 100,000 pF as 104. (For values below 10pF use "R" in place of decimal point, e.g., 1R4 = 1.4pF.)

Capacitance Tolerance

COG (NP0):
D = ±.5pF
(>10pF only)
F = ±1%
(>50pF only)
G = ±2%
(>25pF only)
J = ±5%
K = ±10%

X7R:
J = ±5%
K = ±10%
M = ±20%

Z5U:
M = ±20%
Z = +80%
-20%

Failure Rate

A = Not Applicable
T = CECC

Leads

A = Standard Solderable (SnPb)
T¹ = Trimmed Leads
.230" ± .030"

Not RoHS Compliant

¹ Trimmed lead length for the MR05 style will be measured from the bend in the lead (seating plane).

MARKING

Marking is as size permits.
(For code identification, see HOW TO ORDER section.)

- KYOCERA AVX
- Capacitance Tolerance
- Voltage Rating
- Temperature Coefficient
- Date Code
- Lot Code

PACKAGING REQUIREMENTS

Bulk Packaging: 1000 pcs. per sealed package except MR07/MR08 (300 pcs.).

Tape and Reel: Available on MR04, MR05, and MR06 only (2500 pcs./reel).

RADIAL LEADS

Ceramam® - COG (NP0)



SIZE AND CAPACITANCE SPECIFICATIONS

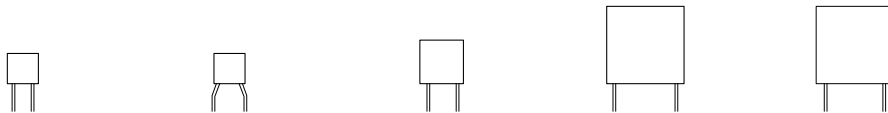

Dimensions: Millimeters (Inches)

Style	MR04	MR05			MR06			MR07			MR08					
		Length	Width	Thickness	Lead Spacing	Lead Diameter	Length	Width	Thickness	Lead Spacing	Lead Diameter	Length	Width	Thickness	Lead Spacing	Lead Diameter
4.83 (.190")	4.83 (.190")	4.83 (.190")	4.83 (.190")	7.36 (.290")	7.36 (.290")	12.44 (.490")	12.44 (.490")	12.44 (.490")	2.28 (.090")	2.28 (.090")	2.28 (.090")	3.55 (.140")	3.55 (.140")	6.09 (.240")	6.09 (.240")	
2.54 (.100")	.635 (.025")	.635 (.025")	.635 (.025")	.635 (.025")	.635 (.025")	.635 (.025")	.635 (.025")	.635 (.025")	.635 (.025")	.635 (.025")	.635 (.025")	.635 (.025")	.635 (.025")	.635 (.025")	.635 (.025")	
Cap.in. pF	Typical Part Nos.	WVDC			WVDC			WVDC			WVDC			WVDC		
		200	100	50	200	100	50	200	100	50	200	100	50	200	100	50
1.0 to 9.1	MR.....5A1R0DAA to MR.....5A9R1DAA															
10 to 15	MR.....5A100KAA to MR.....5A150KAA															
18 to 27	MR.....5A180KAA to MR.....5A270KAA															
33 to 47	MR.....5A330KAA to MR.....5A470KAA															
56 to 82	MR.....5A560KAA to MR.....5A820KAA															
100 to 150	MR.....5A101KAA to MR.....5A151KAA															
180 to 270	MR.....5A181KAA to MR.....5A271KAA															
330 to 470	MR.....5A331KAA to MR.....5A471KAA															
560 to 820	MR.....5A561KAA to MR.....5A821KAA															
1000 to 1500	MR.....5A102KAA to MR.....5A152KAA															
1800 to 2700	MR.....5A182KAA to MR.....5A272KAA															
3300 to 4700	MR.....5A332KAA to MR.....5A472KAA															
5600 to 8200	MR.....5A562KAA to MR.....5A822KAA															
10,000 to 15,000	MR.....5A103KAA to MR.....5A153KAA															
18,000 to 27,000	MR.....5A183KAA to MR.....5A273KAA															
33,000 to 47,000	MR.....5A333KAA to MR.....5A473KAA															
56,000 to 82,000	MR.....5A563KAA to MR.....5A823KAA															
100,000 to 150,000	MR.....5A104KAA to MR.....5A154KAA															

For trimmed leads see "How To Order".
 For other tolerances see "How To Order".
 For other voltages see "How To Order".

= Industry preferred values

*Length, width and thickness dimensions are ±.254 mm (±.010"). Lead diameter is ±.05 mm (±.002"). Lead spacing is ±.381 mm (±.015").

RADIAL LEADS

Ceramam® - X7R



SIZE AND CAPACITANCE SPECIFICATIONS

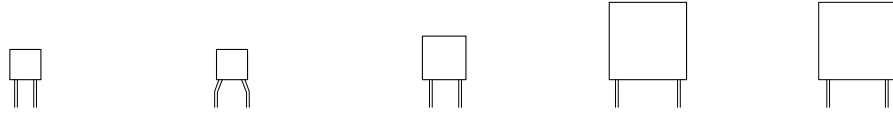

Dimensions: Millimeters (Inches)

Style		MR04	MR05	MR06	MR07	MR08							
Length		4.83 (.190")	4.83 (.190")	7.36 (.290")	12.44 (.490")	12.44 (.490")							
Width		4.83 (.190")	4.83 (.190")	7.36 (.290")	12.44 (.490")	12.44 (.490")							
Thickness		2.28 (.090")	2.28 (.090")	2.28 (.090")	3.55 (.140")	6.09 (.240")							
Lead Spacing		2.54 (.100")	5.08 (.200")	5.08 (.200")	10.16 (.400")	10.16 (.400")							
Lead Diameter		.635 (.025")	.635 (.025")	.635 (.025")	.635 (.025")	.635 (.025")							
Cap. in. pF	Typical Part Nos.	WVDC			WVDC			WVDC			WVDC		
		200	100	50	200	100	50	200	100	50	200	100	50
100	MR.....5C101KAA												
120	MR.....5C121KAA												
150	MR.....5C151KAA												
180	MR.....5C181KAA												
220	MR.....5C221KAA												
270	MR.....5C271KAA												
330	MR.....5C331KAA												
390	MR.....5C391KAA												
470	MR.....5C471KAA												
560	MR.....5C561KAA												
680	MR.....5C681KAA												
820	MR.....5C821KAA												
1000	MR.....5C102KAA												
1200	MR.....5C122KAA												
1500	MR.....5C152KAA												
1800	MR.....5C182KAA												
2200	MR.....5C222KAA												
2700	MR.....5C272KAA												
3300	MR.....5C332KAA												
3900	MR.....5C392KAA												
4700	MR.....5C472KAA												
5600	MR.....5C562KAA												
6800	MR.....5C682KAA												
8200	MR.....5C822KAA												
10,000	MR.....5C103KAA												
12,000	MR.....5C123KAA												
15,000	MR.....5C153KAA												
18,000	MR.....5C183KAA												
22,000	MR.....5C223KAA												
27,000	MR.....5C273KAA												
33,000	MR.....5C333KAA												
39,000	MR.....5C393KAA												
47,000	MR.....5C473KAA												
56,000	MR.....5C563KAA												
68,000	MR.....5C683KAA												
82,000	MR.....5C823KAA												
100,000	MR.....5C104KAA												
120,000	MR.....5C124KAA												
150,000	MR.....5C154KAA												
180,000	MR.....5C184KAA												
220,000	MR.....5C224KAA												
270,000	MR.....5C274KAA												
330,000	MR.....5C334KAA												
390,000	MR.....5C394KAA												
470,000	MR.....5C474KAA												
560,000	MR.....5C564KAA												
680,000	MR.....5C684KAA												
820,000	MR.....5C824KAA												
1.0 pF	MR.....5C105KAA												
1.2 pF	MR.....5C125KAA												
1.5 pF	MR.....5C155KAA												
1.8 pF	MR.....5C185KAA												
2.0 pF	MR.....5C205KAA												
2.2 pF	MR.....5C225KAA												
2.7 pF	MR.....5C275KAA												
3.3 pF	MR.....5C335KAA												
3.9 pF	MR.....5C395KAA												
4.7 pF	MR.....5C475KAA												

For trimmed leads see "How To Order".
For other tolerances see "How To Order".
For other voltages see "How To Order".

= Industry preferred values

*Length, width and thickness dimensions are ±.254 mm (±.010"). Lead diameter is ±.05 mm (±.002"). Lead spacing is ±.381 mm (±.015").



The Important Information/Disclaimer is incorporated in the catalog where these specifications came from or available online at www.kyocera-avx.com/disclaimer/ by reference and should be reviewed in full before placing any order.

TDS-MLCCLD-0013 | Rev 1

RADIAL LEADS

Ceramam® - Z5U



SIZE AND CAPACITANCE SPECIFICATIONS

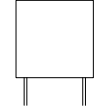
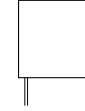

Dimensions: Millimeters (Inches)

Style		MR04		MR05		MR06		MR07		MR08	
		Length*	Width*	Thickness*	Lead* Spacing	Lead* Diameter	Cap. in. pF	Typical Part Nos.	100	50	100
		4.83 (.190")	4.83 (.190")	2.28 (.090")	2.54 (.100")	4.83 (.190")	4.83 (.190")	7.36 (.290")	7.36 (.290")	12.44 (.490")	12.44 (.490")
		4.83 (.190")	4.83 (.190")	2.28 (.090")	2.28 (.090")	7.36 (.290")	7.36 (.290")	12.44 (.490")	12.44 (.490")	12.44 (.490")	12.44 (.490")
		2.28 (.090")	2.28 (.090")	2.28 (.090")	2.28 (.090")	2.28 (.090")	2.28 (.090")	3.55 (.140")	3.55 (.140")	6.09 (.240")	6.09 (.240")
		2.54 (.100")	2.54 (.100")	5.08 (.200")	5.08 (.200")	5.08 (.200")	5.08 (.200")	10.16 (.400")	10.16 (.400")	10.16 (.400")	10.16 (.400")
		.635 (.025")	.635 (.025")	.635 (.025")	.635 (.025")	.635 (.025")	.635 (.025")	.635 (.025")	.635 (.025")	.635 (.025")	.635 (.025")
		WVDC		WVDC		WVDC		WVDC		WVDC	
		100	50	100	50	100	50	100	50	100	50
10,000	MR-----5E103ZAA										
12,000	MR-----5F1237AA										
15,000	MR-----5F1537AA										
18,000	MR-----5F1837AA										
22,000	MR-----5F2237AA										
27,000	MR-----5F2737AA										
33,000	MR-----5F3337AA										
39,000	MR-----5F3937AA										
47,000	MR-----5F4737AA										
56,000	MR-----5F5637AA										
68,000	MR-----5F6837AA										
82,000	MR-----5F8237AA										
100,000	MR-----5E104ZAA										
120,000	MR-----5F1247AA										
150,000	MR-----5F1547AA										
180,000	MR-----5F1847AA										
220,000	MR-----5F2247AA										
270,000	MR-----5F2747AA										
330,000	MR-----5F3347AA										
390,000	MR-----5F3947AA										
470,000	MR-----5E474ZAA										
560,000	MR-----5F5647AA										
680,000	MR-----5F6847AA										
820,000	MR-----5F8247AA										
1.0 µF	MR-----5E105ZAA										
1.2 µF	MR-----5F1257AA										
1.5 µF	MR-----5F1557AA										
1.8 µF	MR-----5F1857AA										
2.2 µF	MR-----5F2257AA										
2.7 µF	MR-----5F2757AA										
3.3 µF	MR-----5F3357AA										
3.9 µF	MR-----5F3957AA										
4.7 µF	MR-----5E475ZAA										
5.6 µF	MR-----5F5657AA										
6.8 µF	MR-----5F6857AA										
8.2 µF	MR-----5F8257AA										
10.0 µF	MR-----5E106ZAA										

For trimmed leads see "How To Order".
For other tolerances see "How To Order".
For other voltages see "How To Order".

= Industry preferred values

*Length, width and thickness dimensions are ±.254 mm (±.010"). Lead diameter is ±.05 mm (±.002"). Lead spacing is ±.381 mm (±.015).

RADIAL LEADS

Packaging - Tape and Reel

GENERAL INFORMATION

1. Standard reel diameter is 355 millimeters (14 inches) maximum.
2. Reeling standard (#1 or #2) should be specified when ordering.

HOW TO ORDER

To specify tape and reel packaging, add TR1, TR2 or TRX to the end of the KYOCERA AVX 12 digit part number.

Examples:

SR215C104KARTR1
 SR305E105MARTR2
 SR215C103JARTRX

THE INSERTABLES

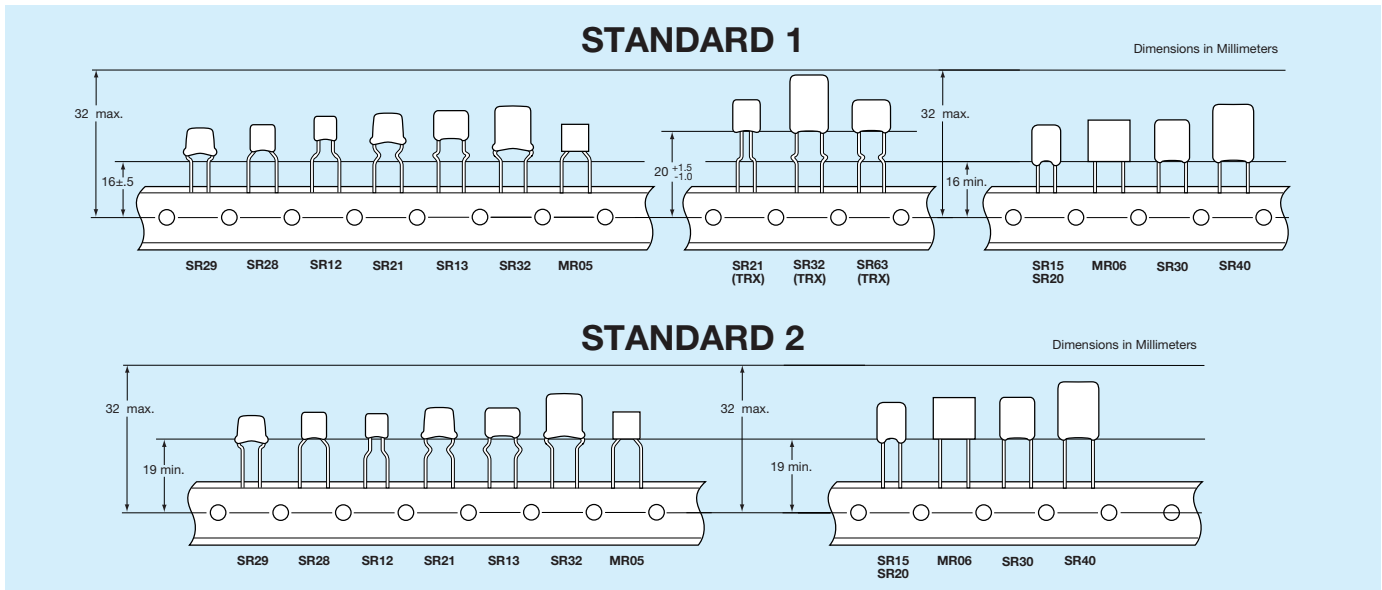
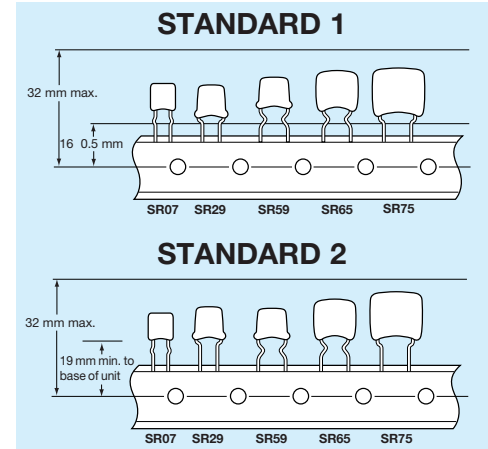

DESCRIPTION

DIMENSIONS (MM)

A. Feed Hole Pitch	12.70 ± .20
B. Feed Hole Diameter	3.99 ± .20
C. Feed Hole Location	9.02 ± .51
D. Component Lead Spacing	5.00 ^{+0.79} _{-.20} or 2.54 ^{+0.79} _{-.20}
E. Component Lead Location	
F. Component Lead Protrusion (The lead wire could end in the edge of carrier tape or before of it, inclusive under adhesive tape)	3.81 ± .51 or 5.00 ± .51 for 2.54 lead spacing
K. Component Body Location	2.00 maximum
L. Carrier Tape Width	6.35 ± .41
M. Carrier Tape Assembly Thickness	18.01 ^{+1.02} _{-.51}
N. Carrier Tape Spliced Thickness	.71 ± .20
O. Carrier Tape Spliced Length	1.42 maximum
Q. Adhesive Tape Border	50.80 - 88.90
R. Component Bent Leads (either direction)	3.00 maximum
S. Component Misalignment	.79 maximum
T. Component Pitch	.99 maximum
W. Adhesive Tape Width	12.70 ± .99
X. Carrier Tape Thickness	5.00 minimum
Y. Cumulative Pitch over 20 Pitches	.51 ± .10
	254 ± 2.00

RADIAL LEADS

Packaging

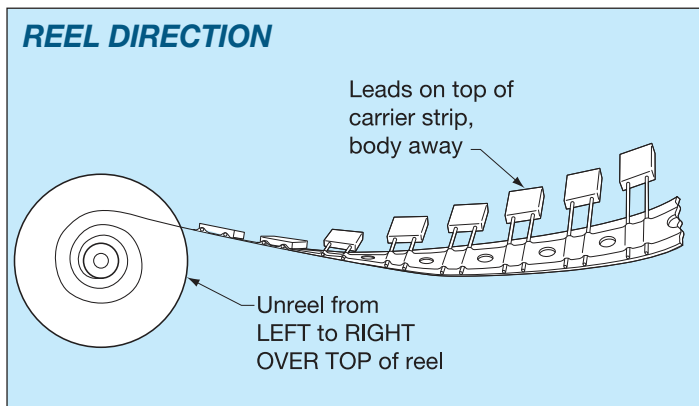

QUANTITY PER REEL SR/AR	
PART	PCS
SR15, 07, 12	3500
SR20, 21, 23, 28 13, 29, 59, 62, 89	3000
SR30, 32, 40, 63, 64 65, 75	2000
MR05, 06	2500

*SL style available in all SR configurations.

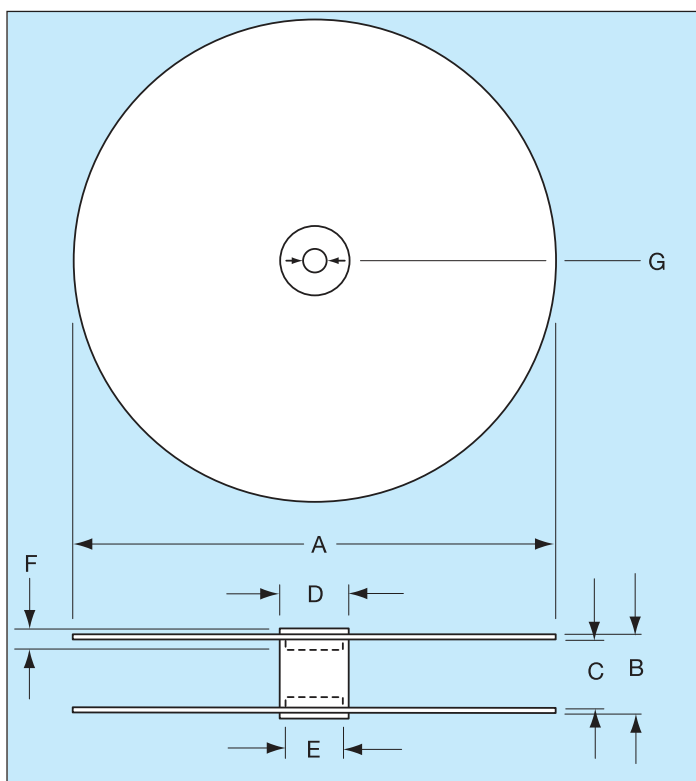

DESCRIPTION	DIMENSIONS (MM)
A - Reel Diameter	304.80 - 355
B - Reel Outside Width	50.80 maximum
C - Reel Inside Width	38.10 - 46.02
D - Core Diameter (O.D.)	102.01 maximum
E - Hub Recess Diameter	86.36 maximum
F - Hub Recess Depth	9.50 minimum
G - Arbor Hole Diameter	25.40 - 30.48

CONVERSION TABLE

MM	IN	MM	IN	MM	IN	MM	IN	MM	IN
.10	.004	1.52	.060	5.00	.197	9.91	.390	32.00	1.260
.20	.007	2.00	.079	5.08	.200	10.03	.395	38.10	1.500
.38	.015	2.54	.100	6.22	.245	10.16	.400	46.02	1.812
.41	.016	3.00	.118	6.35	.250	11.68	.460	50.80	2.000
.51	.020	3.18	.125	6.60	.260	12.50	.492	86.36	3.400
.71	.028	3.48	.137	6.99	.275	12.70	.500	88.90	3.500
.79	.031	3.81	.150	7.62	.300	16.00	.630	102.01	4.016
.99	.039	3.99	.157	8.89	.350	18.01	.709	254.00	10.000
1.02	.040	4.45	.175	9.02	.355	25.40	1.000	304.80	12.000
1.42	.056	4.98	.196	9.50	.374	30.48	1.200	355.00	14.000