

1.8/1.9/2.1GHz BAND LOW NOISE AMPLIFIER GaAs MMIC

■GENERAL DESCRIPTION

NJG1105F is a Low Noise Amplifier GaAs MMIC designed for 1.8/1.9/2.1GHz digital cellular phone handsets such as DCS1800, PCS and W-CDMA.

This amplifier provides low noise figure, high gain and high IP3 operated by single low positive power supply.

■PACKAGE OUTLINE

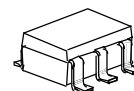

NJG1105F

■FEATURES

- Low voltage operation +2.8V typ.
- Low current consumption 7mA typ.
- High small signal gain 19dB typ. @f=1860MHz
18dB typ. @f=1960MHz
15dB typ. @f=2140MHz
- Low Noise Figure 1.7dB typ. @f=1860/1960/2140MHz
- High Input IP3 -3dBm typ. @f=1860.0+1860.1MHz
-3dBm typ. @f=1960.0+1960.1MHz
+1dBm typ. @f=2140.0+2140.1MHz
- Package MTP6 (Mount Size: 2.8x2.9x1.2mm)

■PIN CONFIGURATION

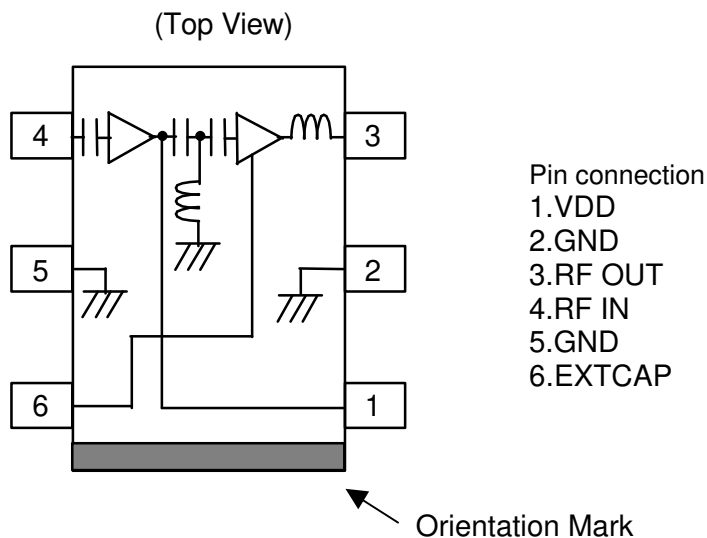

Note: Specifications and description listed in this catalog are subject to change without prior notice.

NJG1105F

■ABSOLUTE MAXIMUM RATINGS

($T_a=+25^{\circ}\text{C}$, $Z_s=Z_l=50\Omega$)

PARAMETER	SYMBOL	CONDITIONS	RATINGS	UNITS
Drain Voltage	V_{DD}		6.5	V
Input Power	P_{in}	$V_{DD}=2.8\text{V}$	+15	dBm
Power Dissipation	P_D		150	mW
Operating Temp.	T_{opr}		-40~+85	$^{\circ}\text{C}$
Storage Temp.	T_{stg}		-55~+125	$^{\circ}\text{C}$

■ELECTRICAL CHARACTERISTICS 1 (1.8GHz Band)

($V_{DD}=2.8\text{V}$, $f=1860\text{MHz}$, $T_a=+25^{\circ}\text{C}$, $Z_s=Z_l=50\Omega$, with application circuit)

PARAMETER	SYMBOL	CONDITIONS	MIN	TYP	MAX	UNITS
Operating Frequency	Freq		1840	1860	1870	MHz
Drain Voltage	V_{DD}		2.7	2.8	5.5	V
Operating Current	I_{DD}	RF OFF	-	7.0	8.5	mA
Small Signal Gain	Gain		17.0	19.0	21.0	dB
Gain Flatness	G_{flat}	$f=1840\sim 1870\text{MHz}$	-	0.5	1.0	dB
Noise Figure	NF		-	1.7	2.0	dB
Pout at 1dB Gain Compression point	P_{-1dB}		+1.0	+5.0	-	dBm
Input 3rd Order Intercept Point	IIP3	$f=1860.0+1860.1\text{MHz}$, $P_{in}=-35\text{dBm}$	-7.0	-3.0	-	dBm
LNAIN Port VSWR	$VSWR_i$		-	1.5	2.0	
LNAOUT Port VSWR	$VSWR_o$		-	1.5	2.0	
Stability		IN/OUT terminal: open or short, No RF input, $T_a=20\sim 80^{\circ}\text{C}$, $\text{freq}<20\text{GHz}$	Spurious: -60dBm max. No return gain			

■ELECTRICAL CHARACTERISTICS 2 (1.9GHz Band)

($V_{DD}=2.8\text{V}$, $f=1960\text{MHz}$, $T_a=+25^{\circ}\text{C}$, $Z_s=Z_l=50\Omega$, with application circuit)

PARAMETER	SYMBOL	CONDITIONS	MIN	TYP	MAX	UNITS
Operating Frequency	Freq		1930	1960	1990	MHz
Drain Voltage	V_{DD}		2.7	2.8	5.5	V
Operating Current	I_{DD}	RF OFF	-	7.0	8.5	mA
Small Signal Gain	Gain		16.0	18.0	20.0	dB
Gain Flatness	G_{flat}	$f=1930\sim 1990\text{MHz}$	-	0.5	1.0	dB
Noise Figure	NF		-	1.7	2.0	dB
Pout at 1dB Gain Compression point	P_{-1dB}		+1.0	+4.0	-	dBm
Input 3rd Order Intercept Point	IIP3	$f=1960.0+1960.1\text{MHz}$, $P_{in}=-35\text{dBm}$	-7.0	-3.0	-	dBm
LNAIN Port VSWR	$VSWR_i$		-	1.5	2.0	
LNAOUT Port VSWR	$VSWR_o$		-	1.5	2.0	
Stability		IN/OUT terminal: open or short, No RF input, $T_a=20\sim 80^{\circ}\text{C}$, $\text{freq}<20\text{GHz}$	Spurious: -60dBm max. No return gain			

■ELECTRICAL CHARACTERISTICS 3 (2.1GHz Band)

($V_{DD}=2.8V$, $f=2140MHz$, $T_a=+25^{\circ}C$, $Z_s=Z_l=50\Omega$, with application circuit)

PARAMETER	SYMBOL	CONDITIONS	MIN	TYP	MAX	UNITS
Operating Frequency	Freq		2110	2140	2170	MHz
Drain Voltage	V_{DD}		2.7	2.8	5.5	V
Operating Current	I_{DD}	RF OFF	-	7.0	8.5	mA
Small Signal Gain	Gain		13.0	15.0	17.0	dB
Gain Flatness	G_{flat}	$f=2110\sim 2140MHz$	-	0.5	1.0	dB
Noise Figure	NF		-	1.7	1.9	dB
Pout at 1dB Gain Compression point	P_{-1dB}		+1.0	+4.0	-	dBm
Input 3rd Order Intercept Point	IIP3	$f=2140.0+2140.1MHz$, $P_{in}=-35dBm$	-4.0	+1.0	-	dBm
LNAIN Port VSWR	$VSWR_i$		-	1.5	2.0	
LNAOUT Port VSWR	$VSWR_o$		-	1.5	2.0	
Stability		IN/OUT terminal: open or short, No RF input, $T_a=20\sim 80^{\circ}C$, $freq<20GHz$	Spurious: -60dBm max. No return gain			

■ELECTRICAL CHARACTERISTICS 4 (1.8GHz Band, High Gain version)

($V_{DD}=2.8V$, $f=1860MHz$, $T_a=+25^{\circ}C$, $Z_s=Z_l=50\Omega$, with application circuit)

PARAMETER	SYMBOL	CONDITIONS	MIN	TYP	MAX	UNITS
Operating Frequency	Freq		1840	1860	1870	MHz
Drain Voltage	V_{DD}		2.7	2.8	5.5	V
Operating Current	I_{DD}	RF OFF	-	7.0	8.5	mA
Small Signal Gain	Gain		18.0	20.0	22.0	dB
Gain Flatness	G_{flat}	$f=1840\sim 1870MHz$	-	0.5	1.0	dB
Noise Figure	NF		-	1.9	2.2	dB
Pout at 1dB Gain Compression point	P_{-1dB}		+1.0	+4.0	-	dBm
Input 3rd Order Intercept Point	IIP3	$f=1860.0+1860.1MHz$, $P_{in}=-35dBm$	-7.5	-4.5	-	dBm
LNAIN Port VSWR	$VSWR_i$		-	1.5	2.0	
LNAOUT Port VSWR	$VSWR_o$		-	1.5	2.0	
Stability		IN/OUT terminal: open or short, No RF input, $T_a=20\sim 80^{\circ}C$, $freq<20GHz$	Spurious: -60dBm max. No return gain			

NJG1105F

■ELECTRICAL CHARACTERISTICS 5 (1.9GHz Band, High Gain version)

($V_{DD}=2.8V$, $f=1960MHz$, $T_a=+25^{\circ}C$, $Z_s=Z_l=50\Omega$, with application circuit)

PARAMETER	SYMBOL	CONDITIONS	MIN	TYP	MAX	UNITS
Operating Frequency	Freq		1930	1960	1990	MHz
Drain Voltage	V_{DD}		2.7	2.8	5.5	V
Operating Current	I_{DD}	RF OFF	-	7.0	8.5	mA
Small Signal Gain	Gain		17.5	19.5	21.5	dB
Gain Flatness	G_{flat}	$f=1930\sim 1990MHz$	-	0.8	1.1	dB
Noise Figure	NF		-	1.9	2.2	dB
Pout at 1dB Gain Compression point	P_{-1dB}		+1.0	+4.0	-	dBm
Input 3rd Order Intercept Point	IIP3	$f=1960.0+1960.1MHz$ Pin=-35dBm	-8.5	-4.5	-	dBm
LNAIN Port VSWR	$VSWR_i$		-	1.5	2.0	
LNAOUT Port VSWR	$VSWR_o$		-	2.0	3.0	
Stability		IN/OUT terminal: open or short, No RF input, $T_a=20\sim 80^{\circ}C$, freq<20GHz	Spurious: -60dBm max. No return gain			

■ELECTRICAL CHARACTERISTICS 6 (2.1GHz Band, High Gain version 1)

($V_{DD}=2.8V$, $f=2140MHz$, $T_a=+25^{\circ}C$, $Z_s=Z_l=50\Omega$, with application circuit)

PARAMETER	SYMBOL	CONDITIONS	MIN	TYP	MAX	UNITS
Operating Frequency	Freq		2110	2140	2170	MHz
Drain Voltage	V_{DD}		2.7	2.8	5.5	V
Operating Current	I_{DD}	RF OFF	-	7.0	8.5	mA
Small Signal Gain	Gain		13.0	15.0	17.0	dB
Gain Flatness	G_{flat}	$f=2110\sim 2140MHz$	-	0.5	1.0	dB
Noise Figure	NF		-	1.7	1.9	dB
Pout at 1dB Gain Compression point	P_{-1dB}		0.0	+3.0	-	dBm
Input 3rd Order Intercept Point	IIP3	$f=2140.0+2140.1MHz$, Pin=-35dBm	-6.5	-3.5	-	dBm
LNAIN Port VSWR	$VSWR_i$		-	2.0	2.5	
LNAOUT Port VSWR	$VSWR_o$		-	1.5	2.0	
Stability		IN/OUT terminal: open or short, No RF input, $T_a=20\sim 80^{\circ}C$, freq<20GHz	Spurious: -60dBm max. No return gain			

■ELECTRICAL CHARACTERISTICS 7 (2.1GHz Band, High Gain version 2)

($V_{DD}=2.8V$, $f=2140MHz$, $T_a=+25^{\circ}C$, $Z_s=Z_l=50\Omega$, with application circuit)

PARAMETER	SYMBOL	CONDITIONS	MIN	TYP	MAX	UNITS
Operating Frequency	Freq		2110	2140	2170	MHz
Drain Voltage	V_{DD}		2.7	2.8	5.5	V
Operating Current	I_{DD}	RF OFF	-	7.0	8.5	mA
Small Signal Gain	Gain		15.0	17.0	19.0	dB
Gain Flatness	G_{flat}	$f=2110\sim 2140MHz$	-	0.5	1.0	dB
Noise Figure	NF		-	1.7	1.9	dB
Pout at 1dB Gain Compression point	P_{-1dB}		+1.0	+4.0	-	dBm
Input 3rd Order Intercept Point	IIP3	$f=2140.0+2140.1MHz$, $P_{in}=-35dBm$	-5.5	-2.5	-	dBm
LNAIN Port VSWR	$VSWR_i$		-	2.0	2.5	
LNAOUT Port VSWR	$VSWR_o$		-	1.5	2.0	
Stability		IN/OUT terminal: open or short, No RF input, $T_a=20\sim 80^{\circ}C$, $freq<20GHz$	Spurious: -60dBm max. No return gain			

NJG1105F

■ TERMINAL INFORMATION

Pin	Function	Description
1	VDD	Bias voltage supply terminal for 1 st stage amplifier. Optimized value of inductor L4 is required because it works as matching element. (Please refer to "RECOMMENDED CIRCUIT")
2,5	GND	Ground pin (0V).
3	RFout	RF output and voltage supply pin of 2 nd stage amplifier. External matching circuits and a bypass capacitor is required. Inductors C4, L3 work as external output matching elements. (Please refer to "RECOMMENDED CIRCUIT")
4	RFin	RF input pin. No DC blocking capacitor is required, but an external matching circuit is required. (Please refer to "RECOMMENDED CIRCUIT")
6	EXTCAP	An external bypass capacitor is required. This capacitor works as external matching element. (Please refer to "RECOMMENDED CIRCUIT")

■ TYPICAL CHARACTERISTICS (1.8GHz BAND)

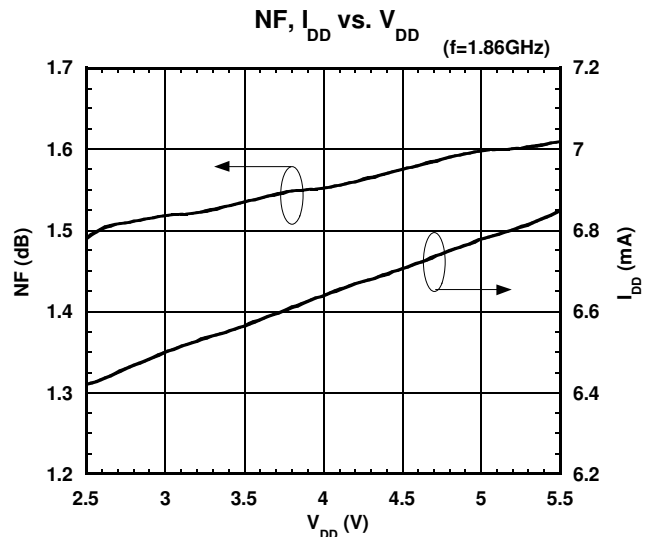
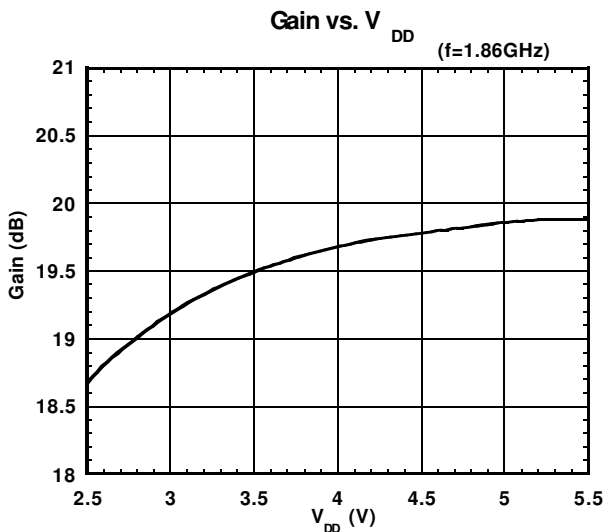
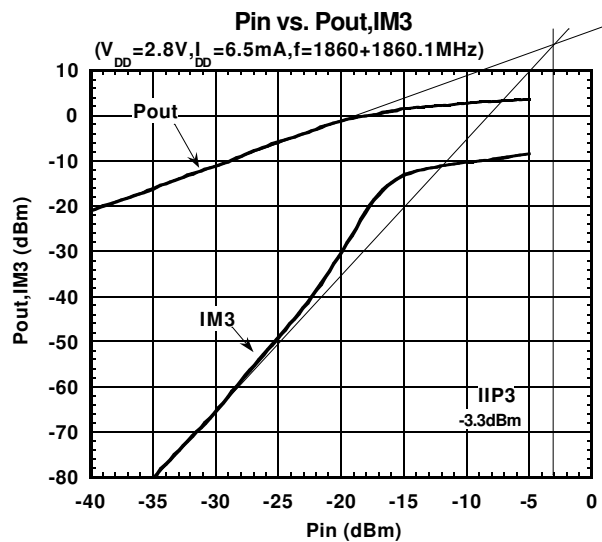
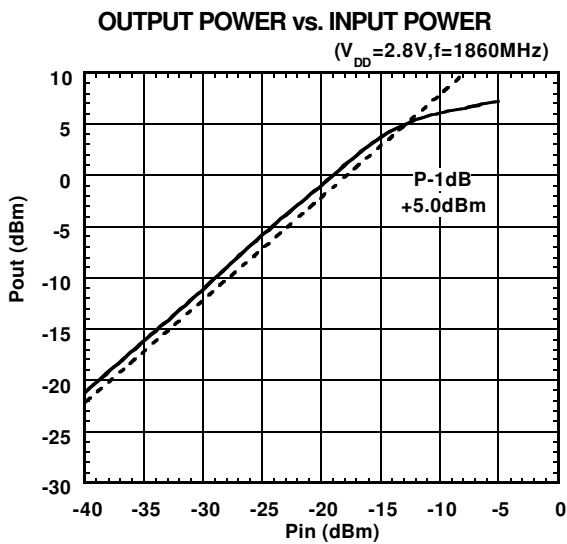
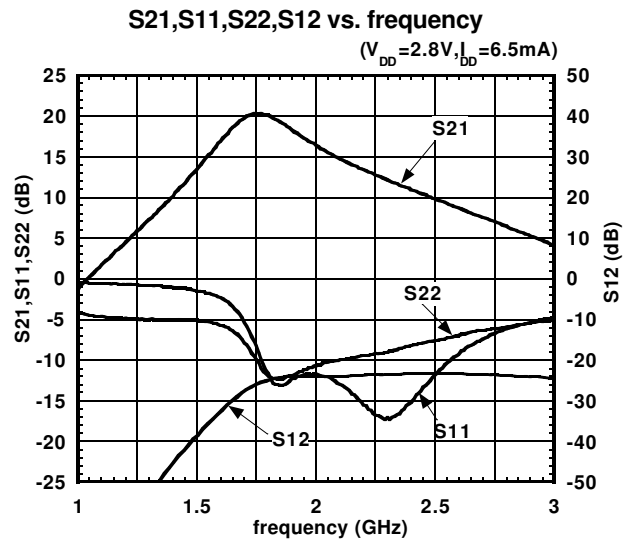
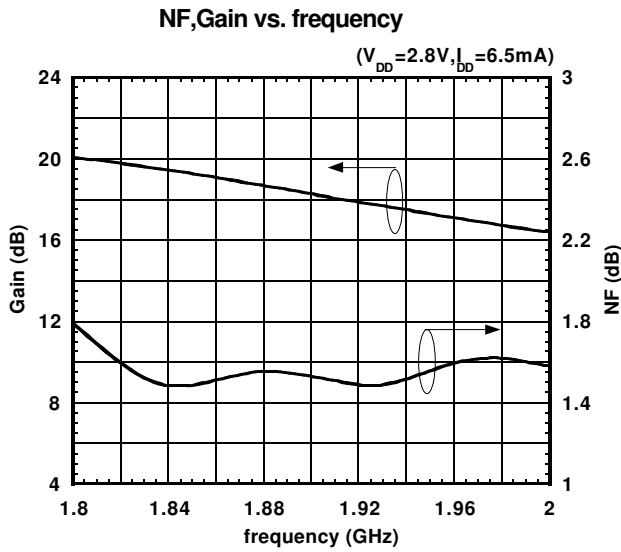

NJG1105F

TYPICAL CHARACTERISTICS (1.8GHz BAND)

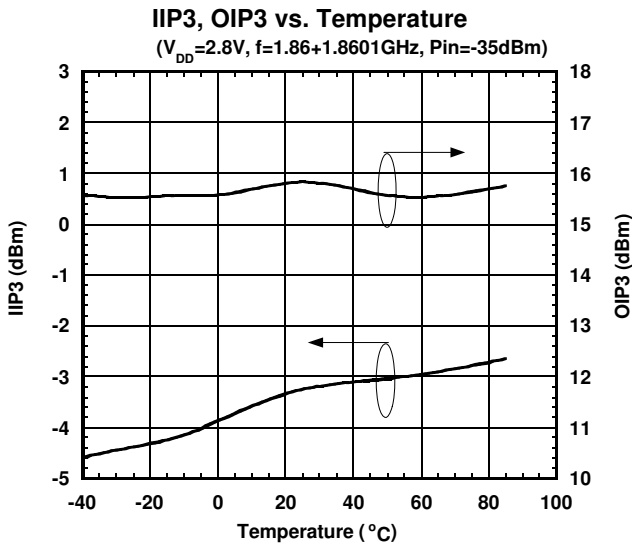
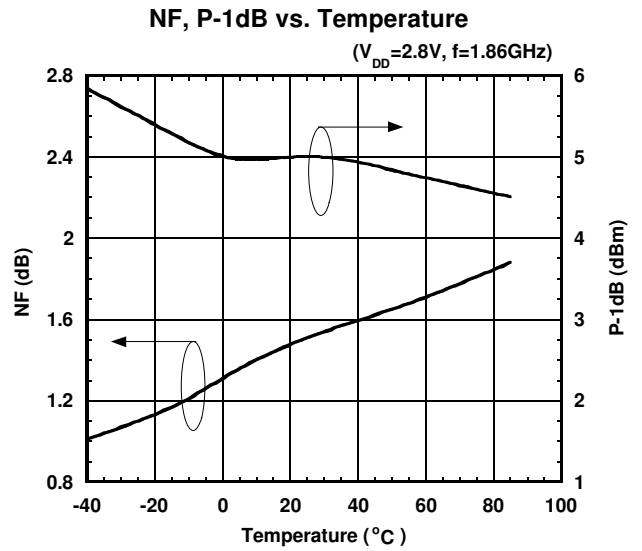
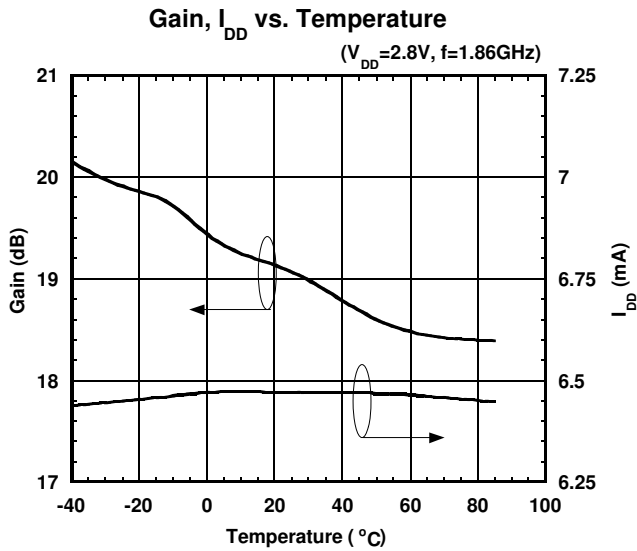
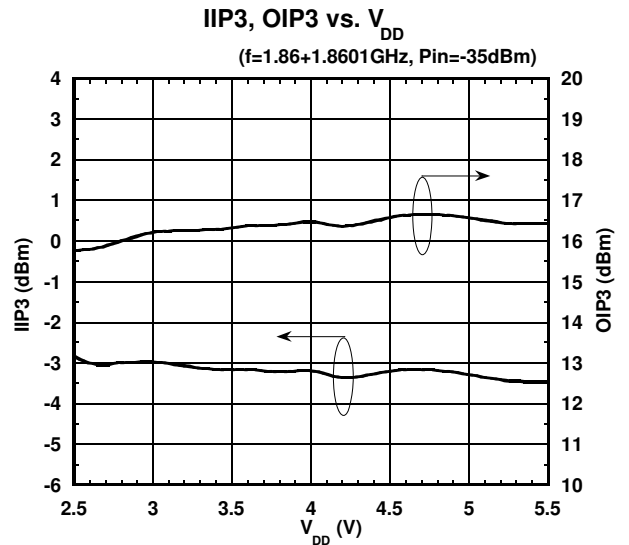
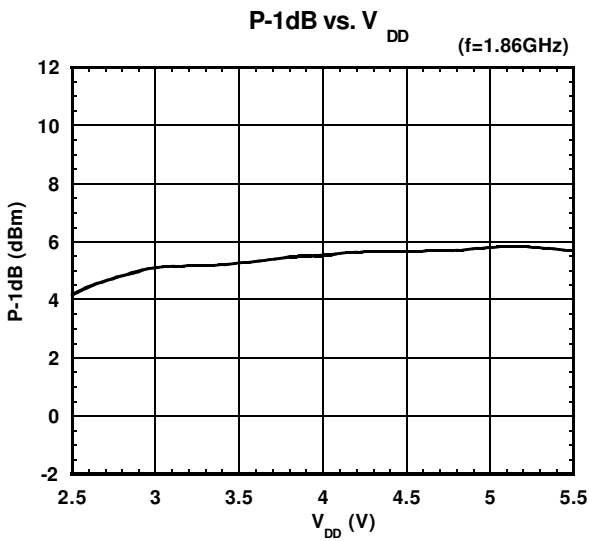

Equations of OIP3 and IIP3

$$OIP3 = \frac{3 \times P_{out} - IM3}{2}$$

$$IIP3 = OIP3 - Gain \text{ @ Pin}=-40\text{dBm}$$

■ TYPICAL CHARACTERISTICS (1.8GHz BAND)

S11 vs. frequency (to 20GHz)

($V_{DD}=2.8V, I_{DD}=6.5mA$)

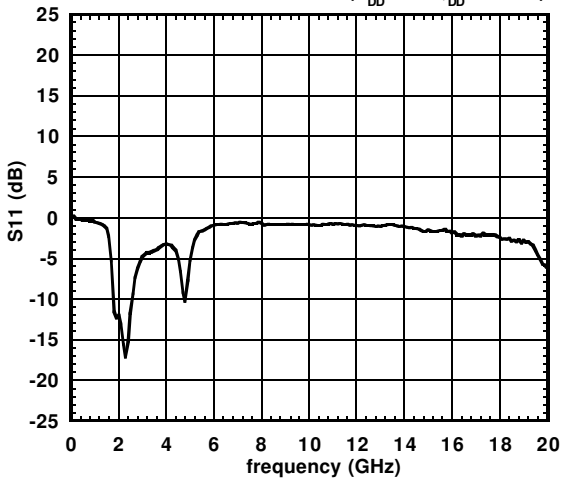

S22 vs. frequency (to 20GHz)

($V_{DD}=2.8V, I_{DD}=6.5mA$)

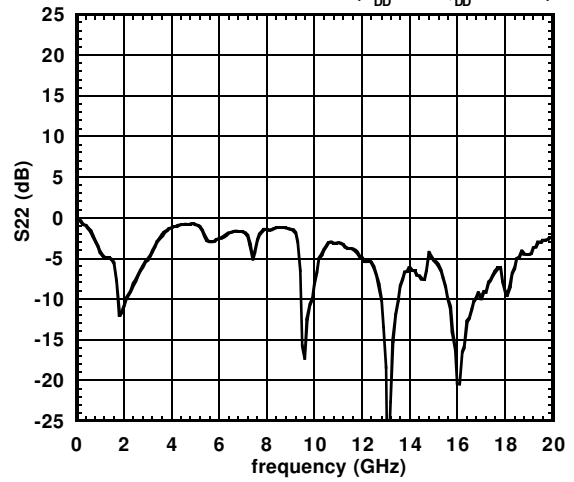

S21 vs. frequency (to 20GHz)

($V_{DD}=2.8V, I_{DD}=6.5mA$)

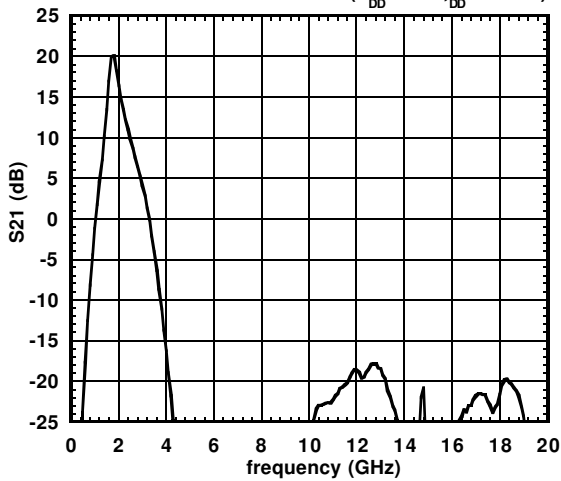

S12 vs. frequency (to 20GHz)

($V_{DD}=2.8V, I_{DD}=6.5mA$)

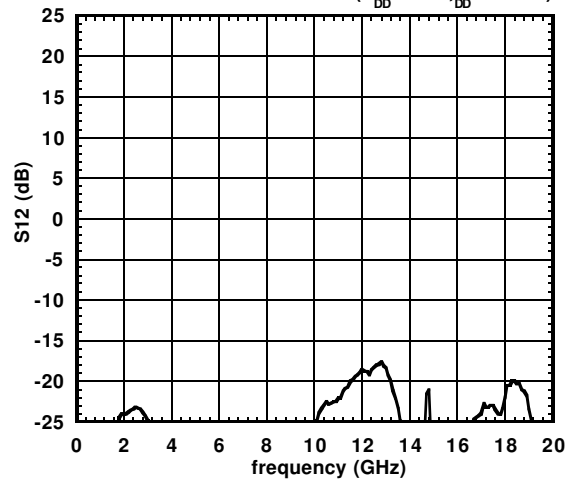

NJG1105F

TYPICAL CHARACTERISTICS (1.9GHz BAND)

NF, Gain vs. frequency

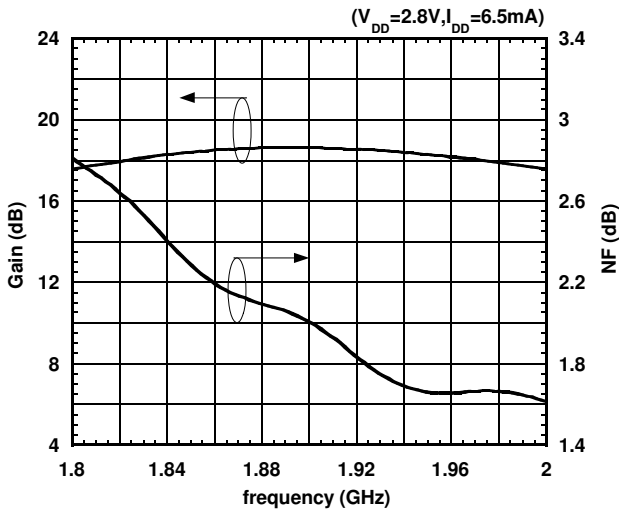

S21, S11, S22 vs. frequency

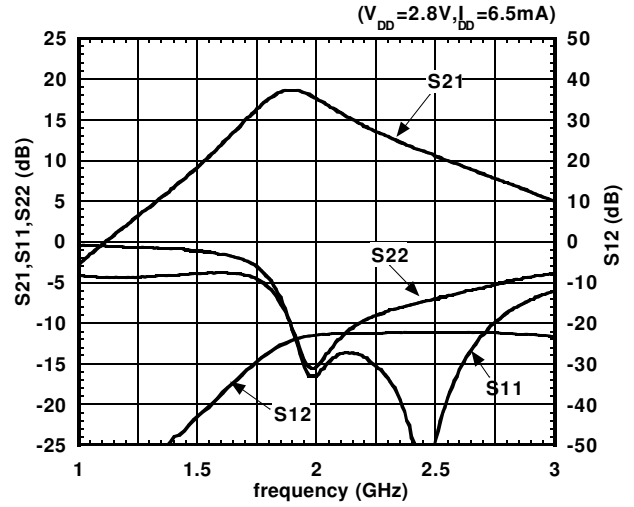

OUTPUT POWER vs. INPUT POWER

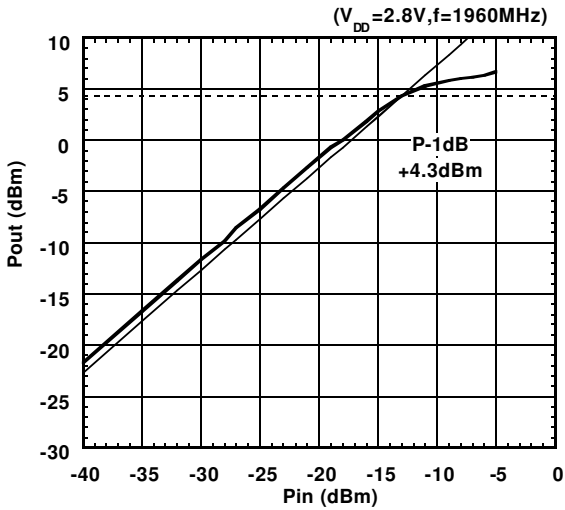

Pin vs. Pout, IM3

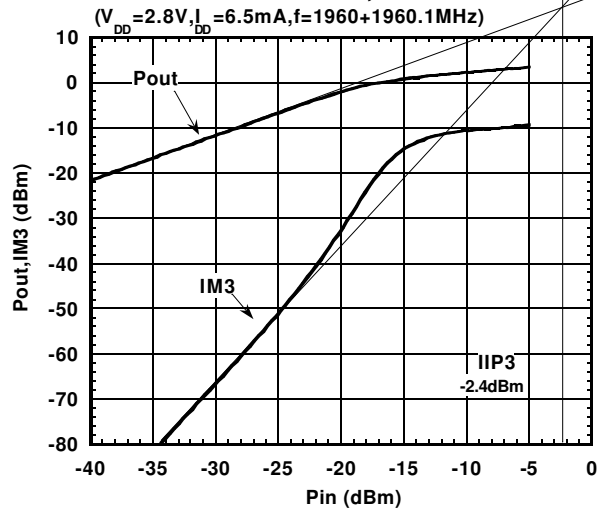

Gain vs. V_{DD}

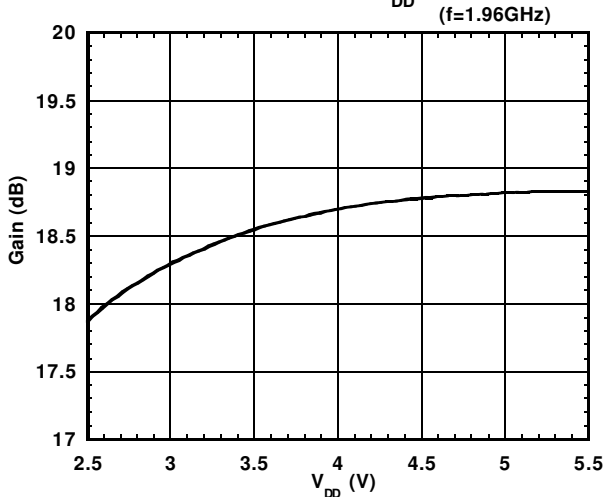

NF, I_{DD} vs. V_{DD}

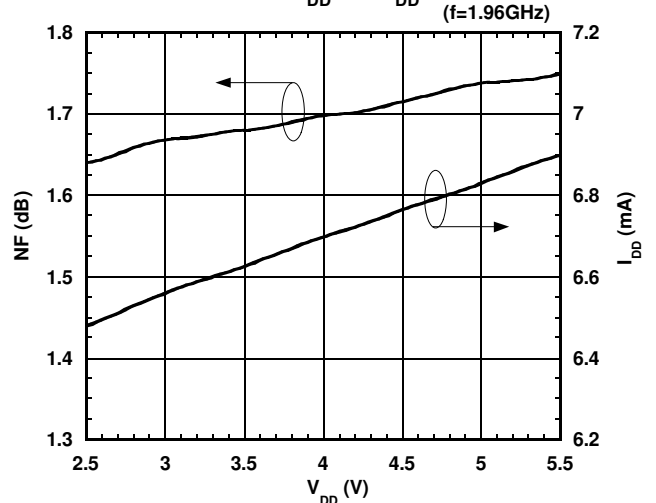

TYPICAL CHARACTERISTICS (1.9GHz BAND)

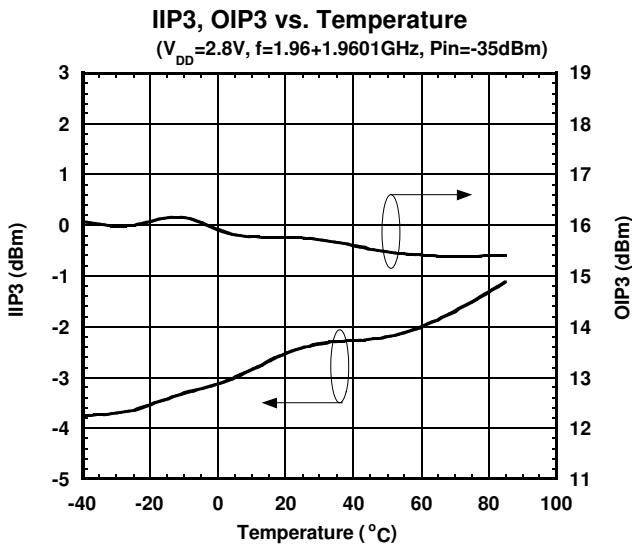
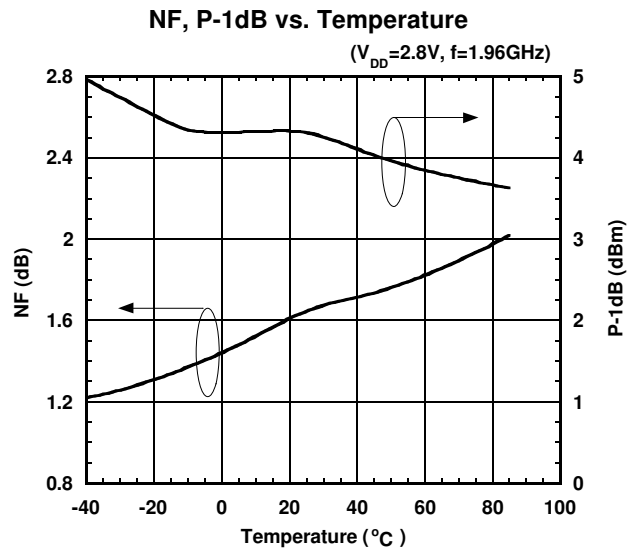
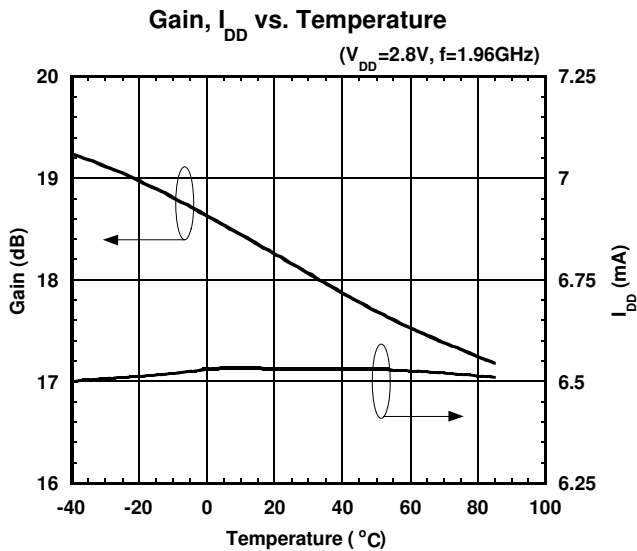
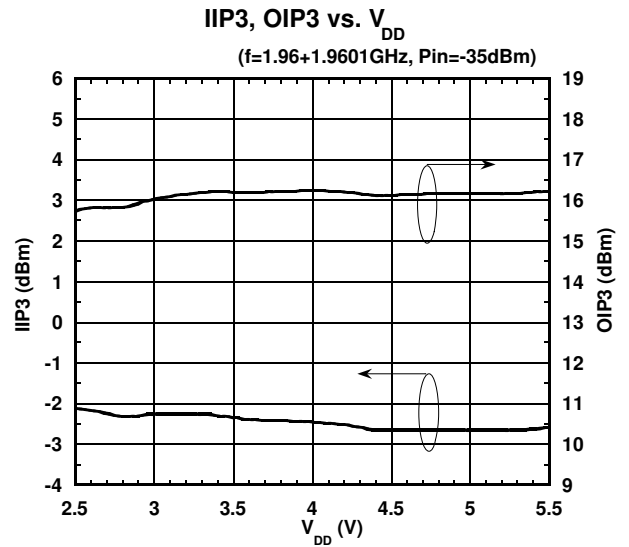
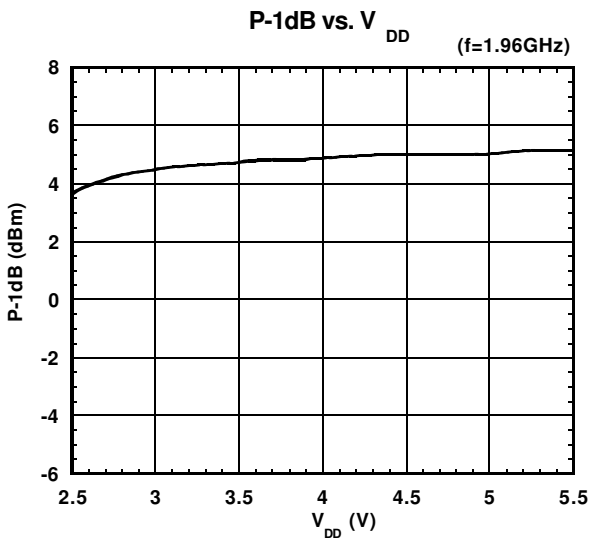

Equations of OIP3 and IIP3

$$OIP3 = \frac{3 \times P_{out} - IM3}{2}$$

$$IIP3 = OIP3 - \text{Gain} \quad @ \quad P_{in} = -40\text{dBm}$$

NJG1105F

■ TYPICAL CHARACTERISTICS (1.9GHz BAND)

S11 vs. frequency (to 20GHz)

($V_{DD}=2.8V, I_{DD}=6.5mA$)

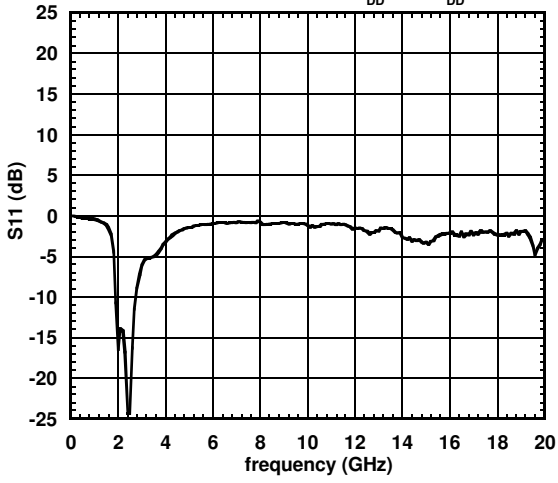

S22 vs. frequency (to 20GHz)

($V_{DD}=2.8V, I_{DD}=6.5mA$)

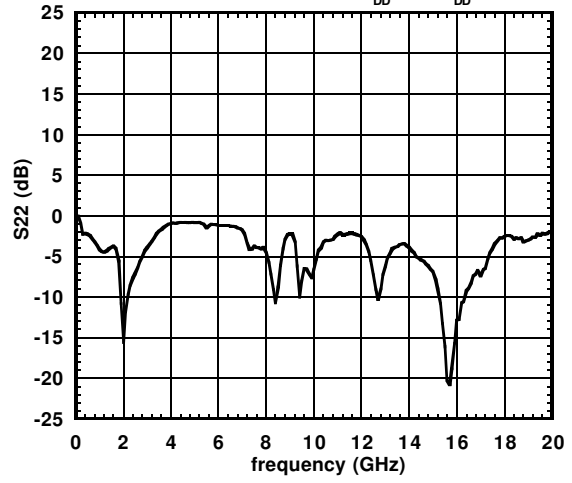

S21 vs. frequency (to 20GHz)

($V_{DD}=2.8V, I_{DD}=6.5mA$)

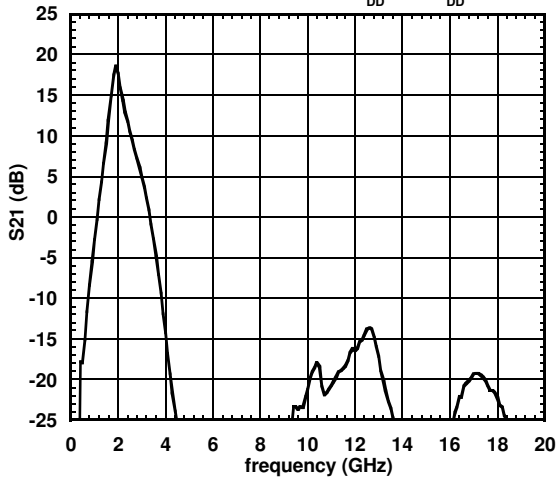

S12 vs. frequency (to 20GHz)

($V_{DD}=2.8V, I_{DD}=6.5mA$)

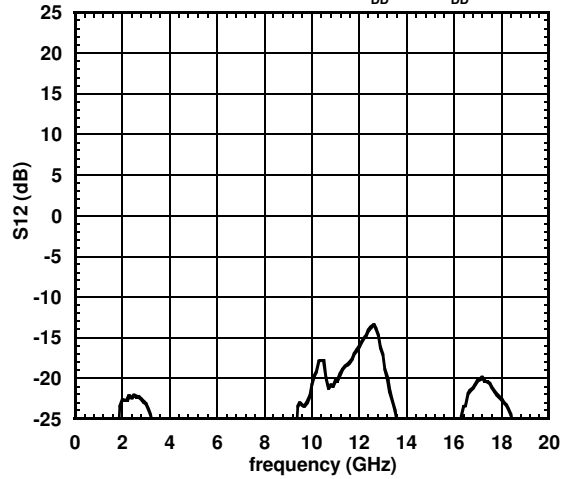

■ TYPICAL CHARACTERISTICS (2.1GHz BAND)

NF, Gain vs. frequency

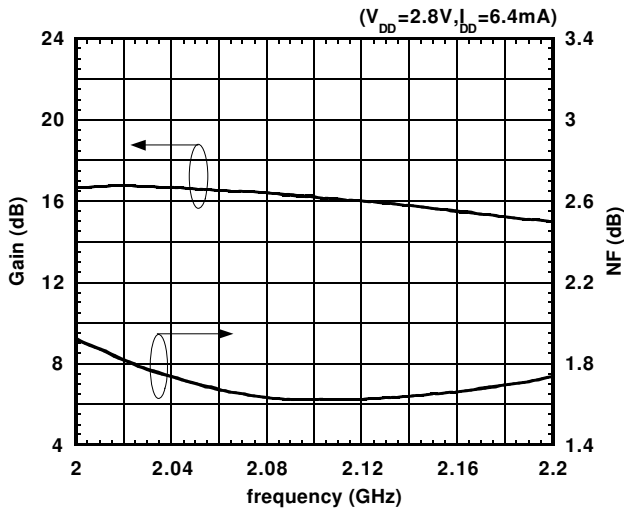

S21, S11, S22, S12 vs. frequency

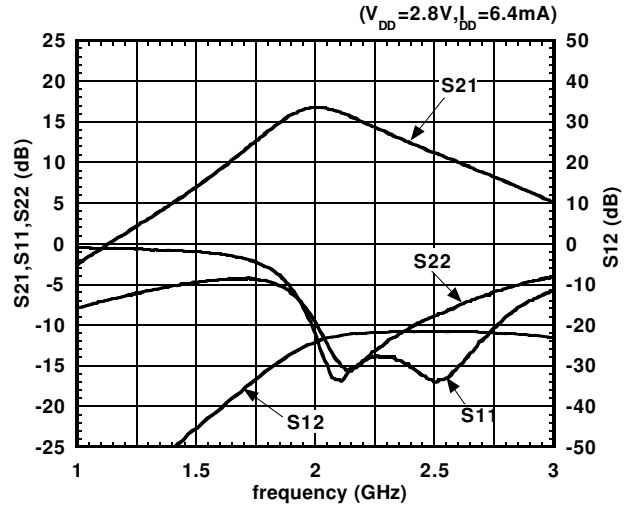

OUTPUT POWER vs. INPUT POWER

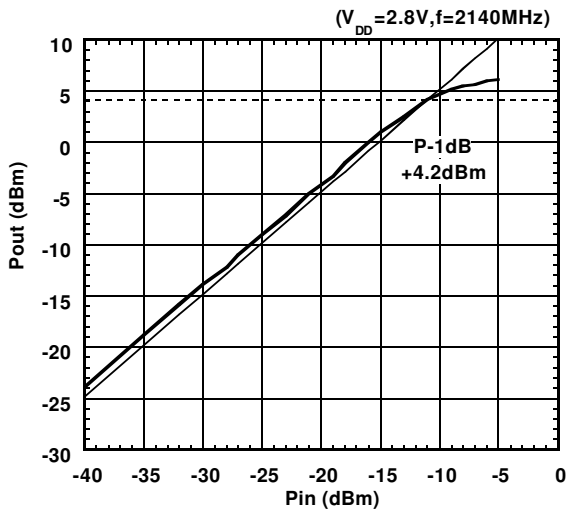

Pin vs. Pout, IM3

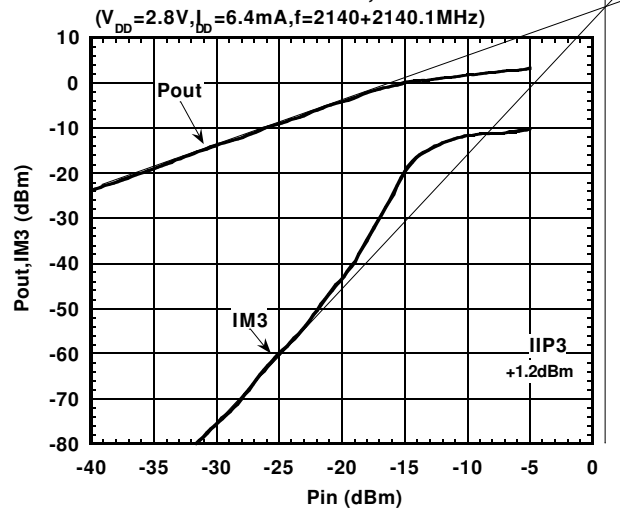

Gain vs. V_{DD}

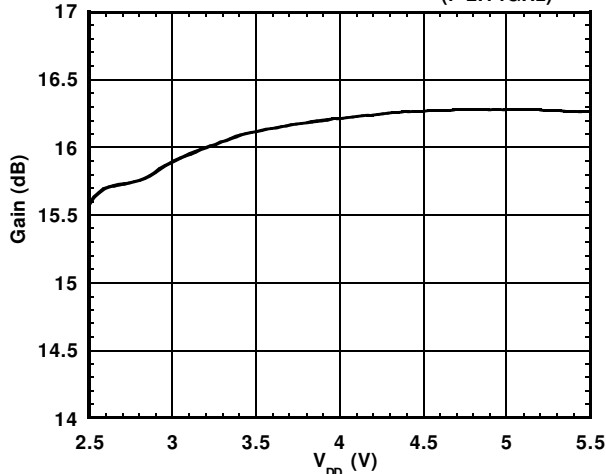

NF, I_{DD} vs. V_{DD}

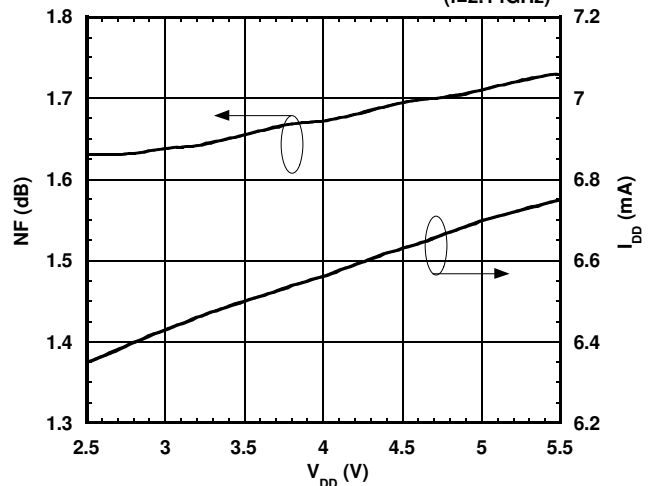

NJG1105F

TYPICAL CHARACTERISTICS (2.1GHz BAND)

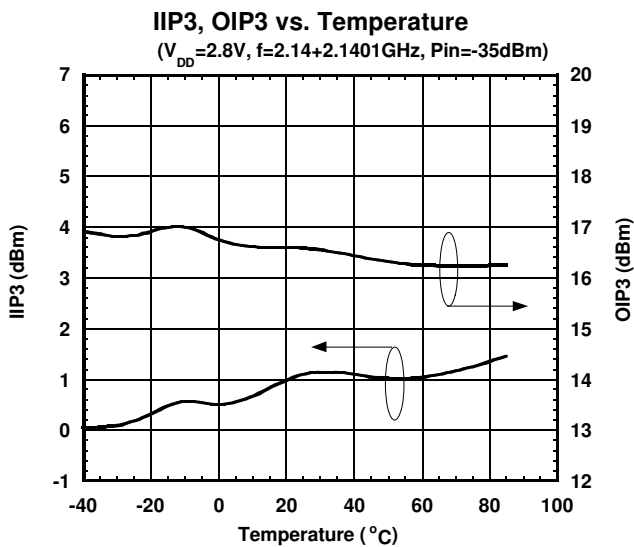
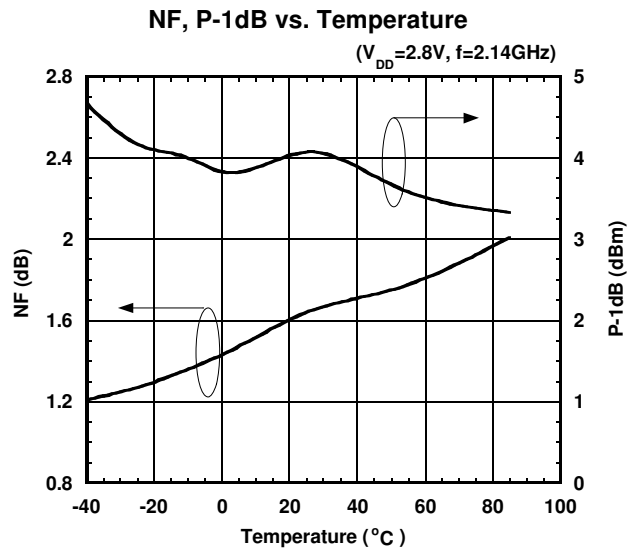
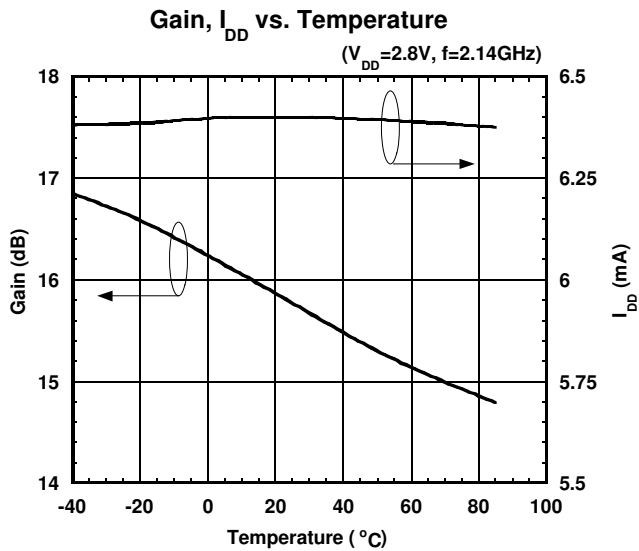
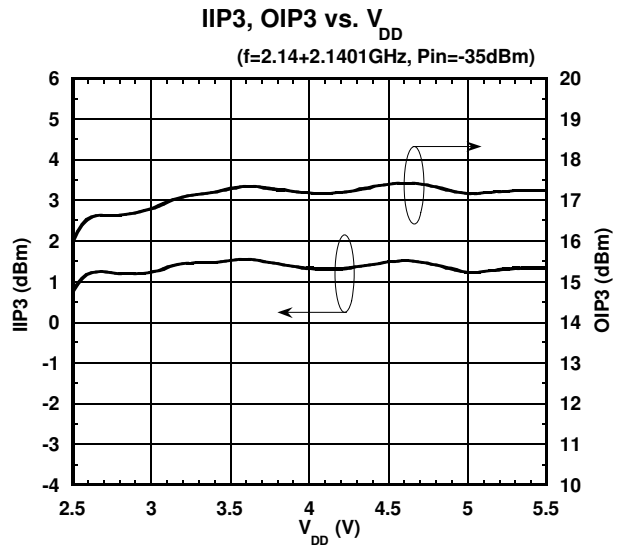
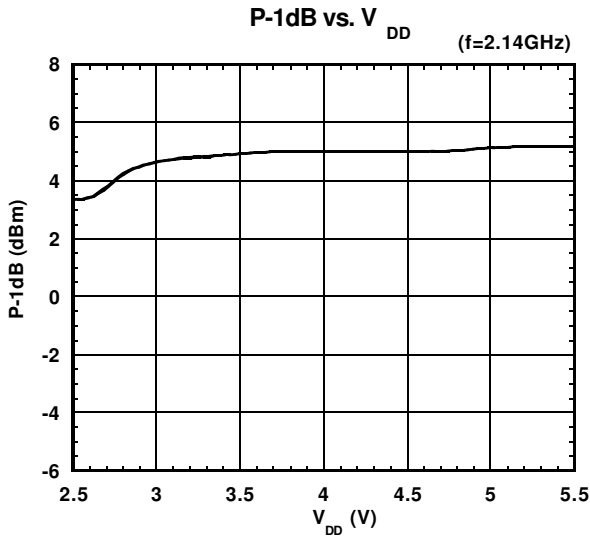

Equations of OIP3 and IIP3

$$OIP3 = \frac{3 \times P_{out} - IM3}{2}$$

$$IIP3 = OIP3 - \text{Gain} \quad @ \text{ Pin} = -40\text{dBm}$$

■ TYPICAL CHARACTERISTICS (2.1GHz BAND)

S11 vs. frequency (to 20GHz)

($V_{DD}=2.8V, I_{DD}=6.4mA$)

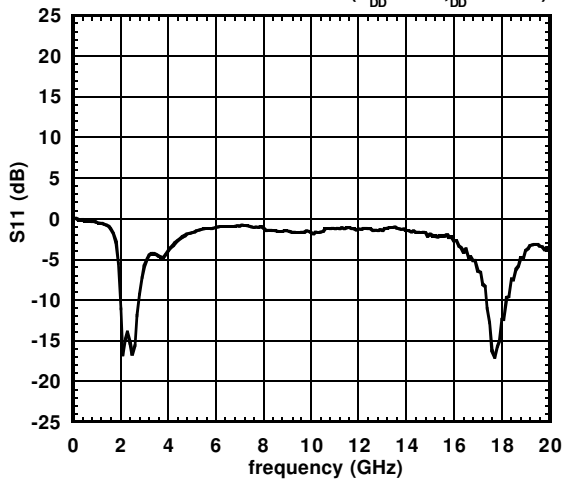

S22 vs. frequency (to 20GHz)

($V_{DD}=2.8V, I_{DD}=6.4mA$)

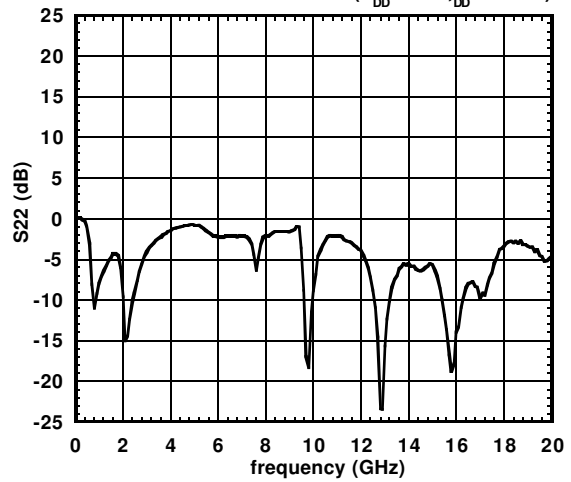

S21 vs. frequency (to 20GHz)

($V_{DD}=2.8V, I_{DD}=6.4mA$)

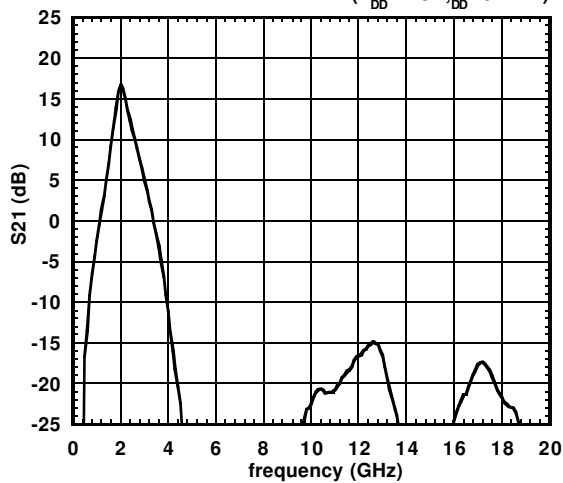

S12 vs. frequency (to 20GHz)

($V_{DD}=2.8V, I_{DD}=6.4mA$)

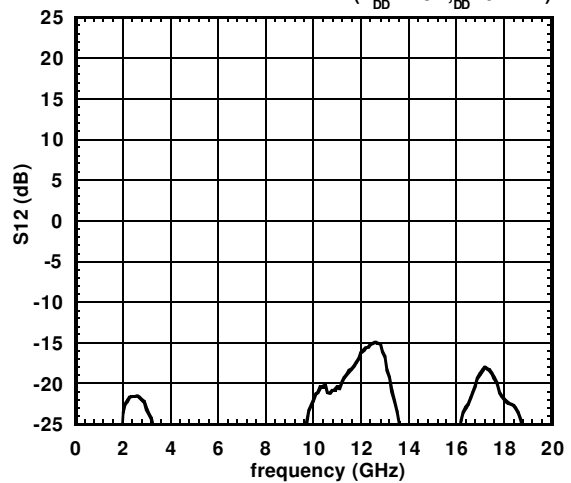

NJG1105F

■ TYPICAL CHARACTERISTICS (1.8GHz BAND: High Gain version)

NF, Gain vs. frequency

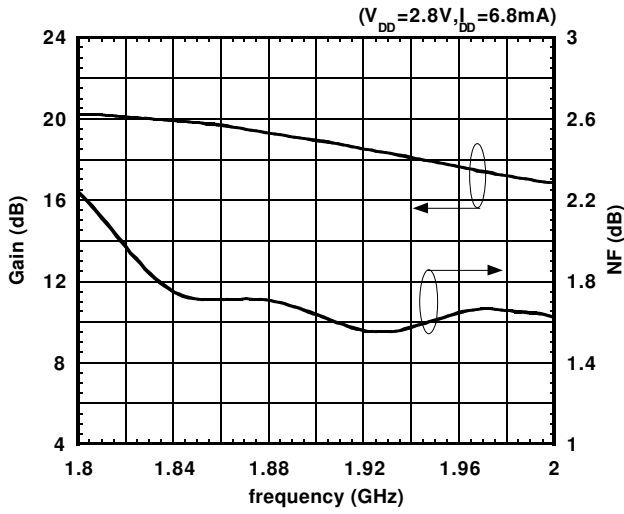

S21, S11, S22, S12 vs. frequency

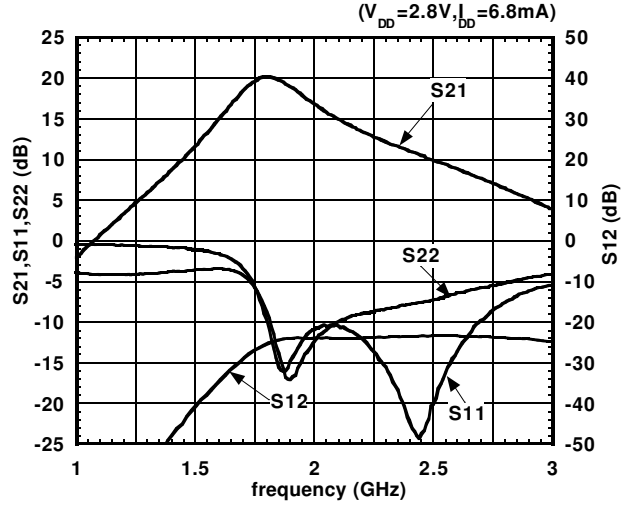

OUTPUT POWER vs. INPUT POWER

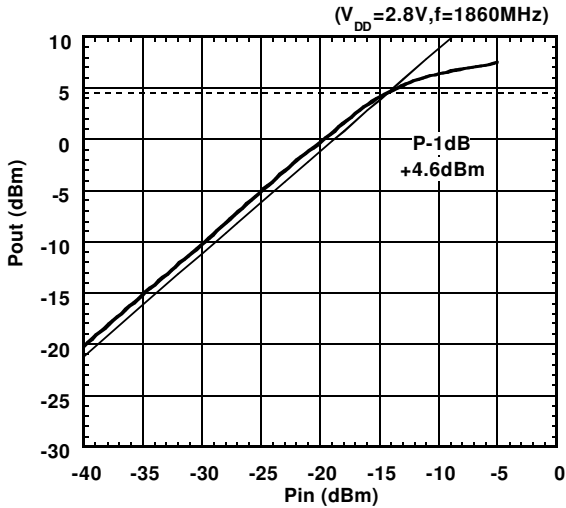

Pin vs. Pout, IM3

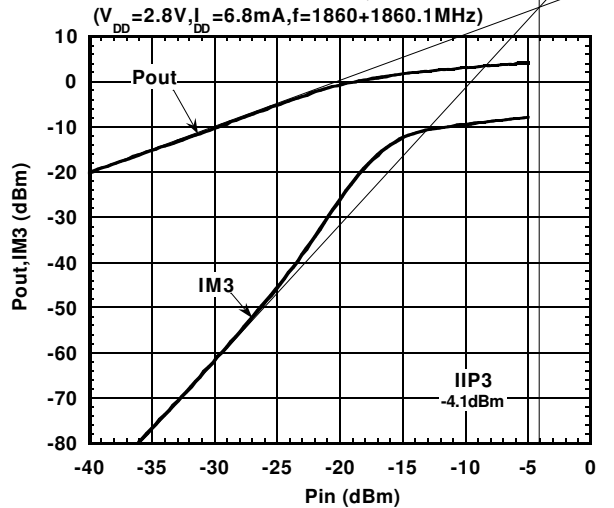

■ TYPICAL CHARACTERISTICS (1.9GHz BAND: High Gain version)

NF, Gain vs. frequency

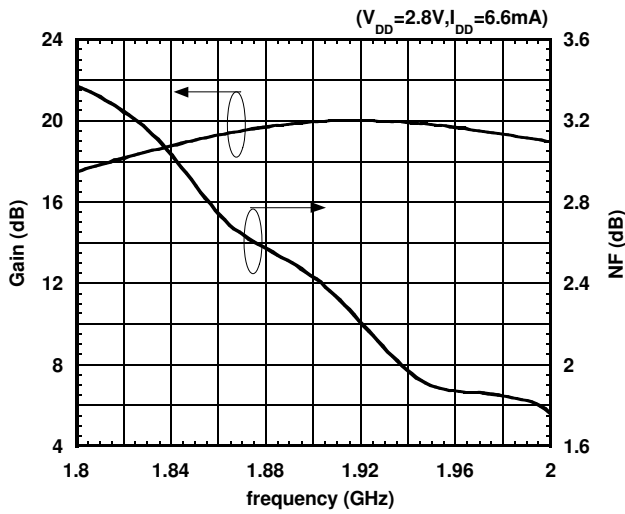

S21, S11, S22, S12 vs. frequency

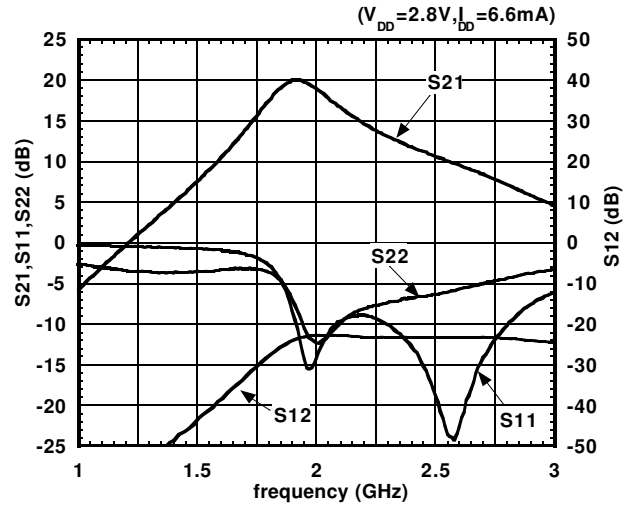

OUTPUT POWER vs. INPUT POWER

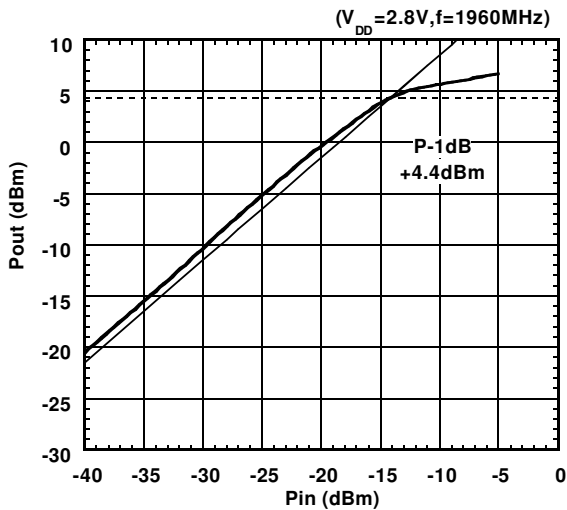

Pin vs. Pout, IM3

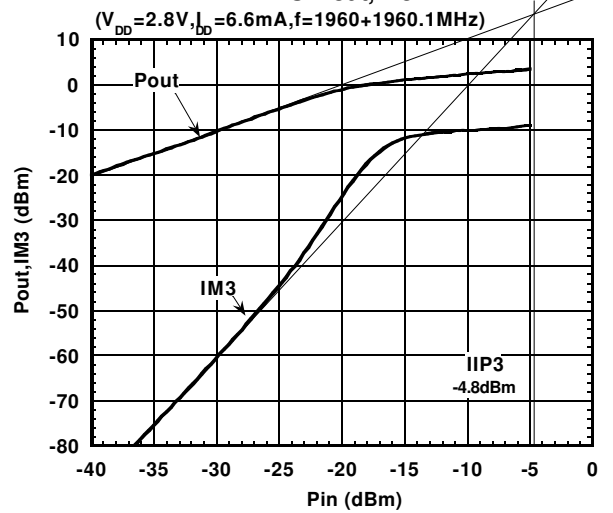

NJG1105F

■ TYPICAL CHARACTERISTICS (2.1GHz BAND: High Gain version 1)

NF, Gain vs. frequency

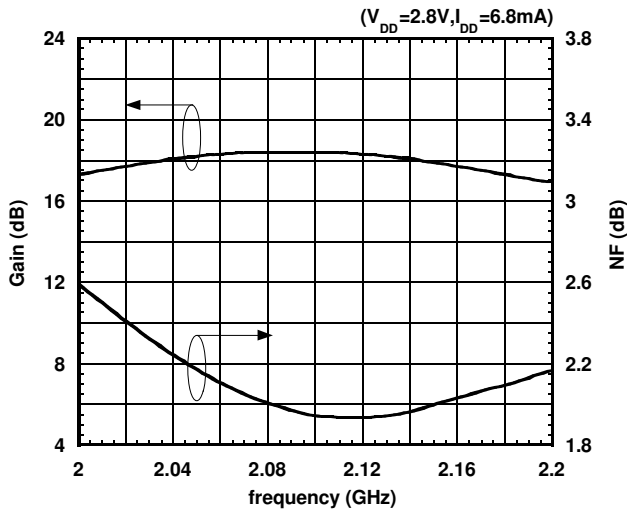

S21, S11, S22, S12 vs. frequency

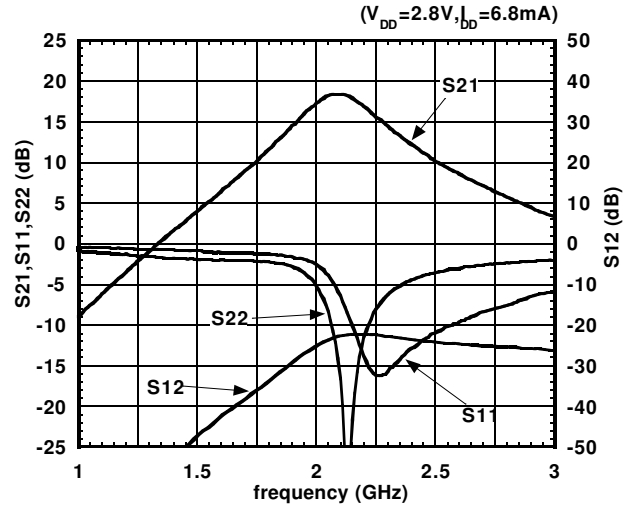

OUTPUT POWER vs. INPUT POWER

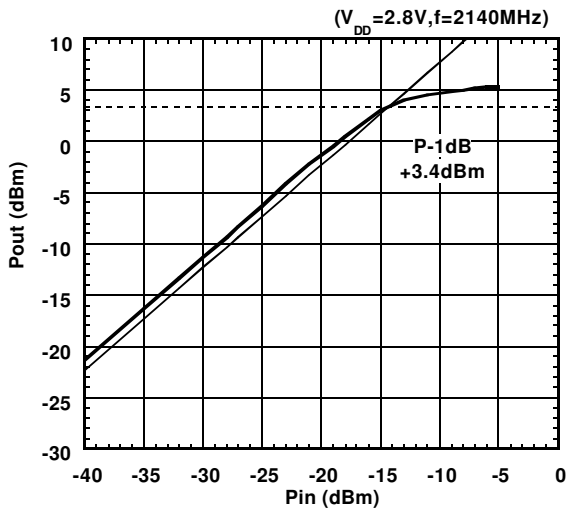

Pin vs. Pout, IM3

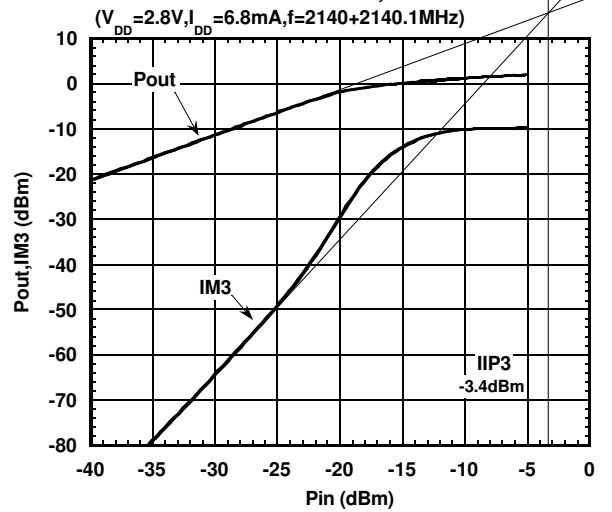

RECOMMENDED CIRCUIT

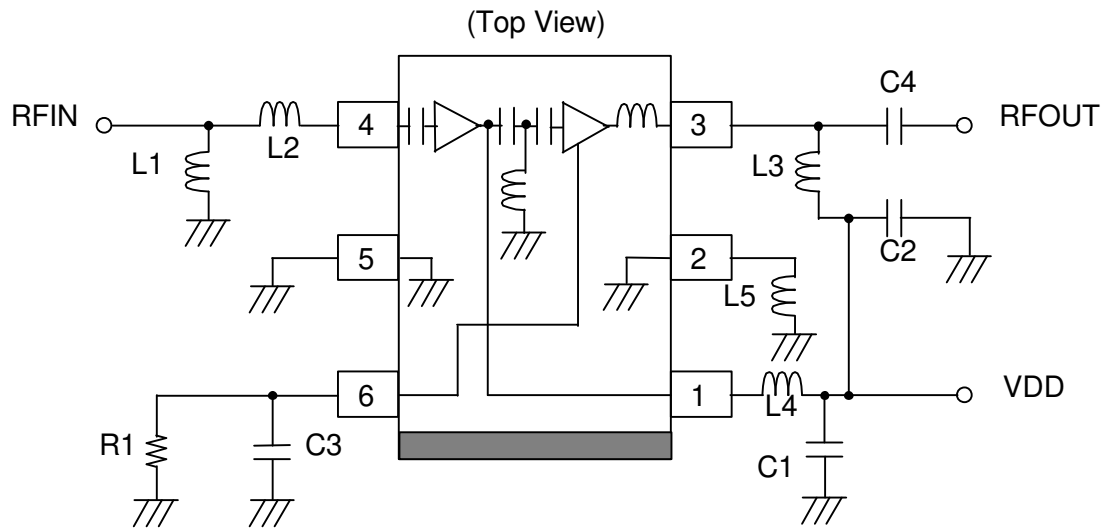

NJG1105F

RECOMMENDED PCB DESIGN

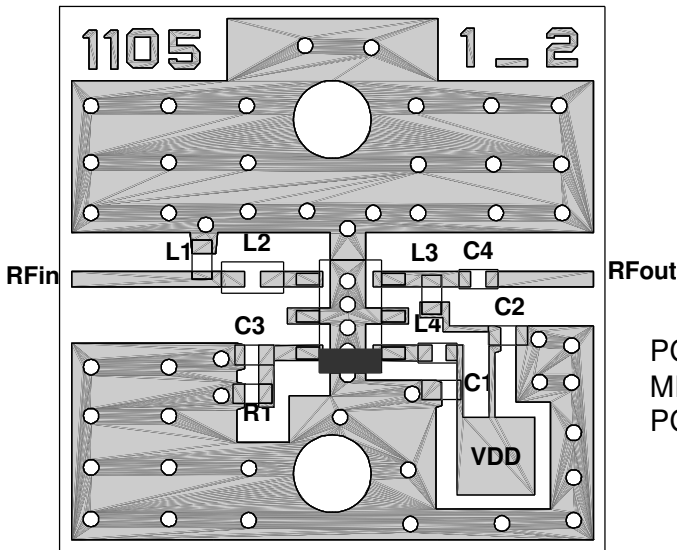

PCB: FR4 t=0.2mm
 MICROSTRIP LINE WIDTH=0.4mm($Z_0=50\Omega$)
 PCB SIZE: 14.0 x 14.0mm

Table 1 PARTS LIST 1

Parts ID	Constant			Comment
	1.8GHz Band	1.9GHz Band	2.1GHz Band	
L1	3.9nH	3.3nH	3.3nH	TAIYO-YUDEN (HK1005)
L2	3.9nH	3.3nH	3.3nH	TAIYO-YUDEN (HK1608)
L3	12nH	27nH	12nH	TAIYO-YUDEN (HK1005)
L4	68nH	22nH	12nH	TAIYO-YUDEN (HK1005)
C1	0.01uF	0.01uF	0.01uF	Murata (GRM36)
C2	0.01uF	0.01uF	0.01uF	Murata (GRM36)
C3	4pF	4pF	4pF	Murata (GRM36)
C4	39pF	13pF	3pF	Murata (GRM36)
R1	330 Ω	330 Ω	330 Ω	1005 Size

Table 2 PARTS LIST 2 (High Gain version)

Parts ID	Constant				Comment
	1.8GHz Band	1.9GHz Band	2.1GHz Band 1	2.1GHz Band 2	
L1	3.3nH	2.7nH	3.9nH	3.3nH	TAIYO-YUDEN (HK1005)
L2	3.9nH	3.3nH	1.5nH	2.7nH	TAIYO-YUDEN (HK1608)
L3	39nH	68nH	100nH	39nH	TAIYO-YUDEN (HK1005)
L4	68nH	22nH	15nH	8.2nH	TAIYO-YUDEN (HK1005)
C1	0.01uF	0.01uF	0.01uF	0.01uF	Murata (GRM36)
C2	0.01uF	0.01uF	0.01uF	0.01uF	Murata (GRM36)
C3	4pF	3pF	2pF	2pF	Murata (GRM36)
C4	16pF	8pF	1.5pF	5pF	Murata (GRM36)
R1	330 Ω	330 Ω	330 Ω	330 Ω	1005 Size

■PACKAGE OUTLINE (MTP6)

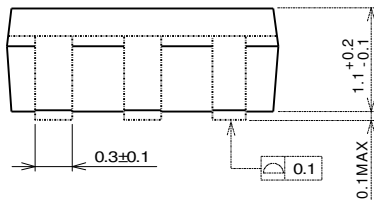
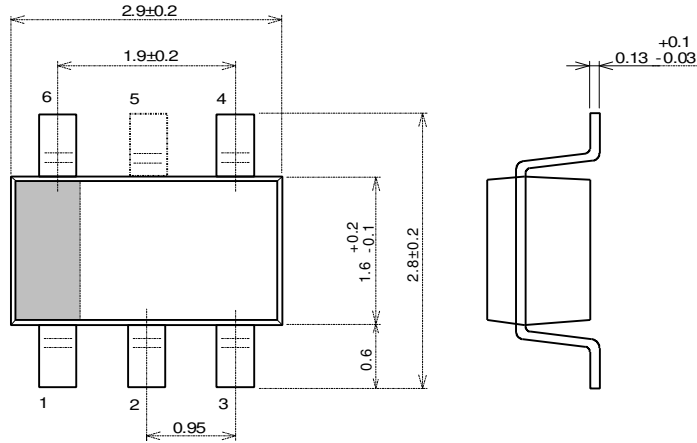

Lead material : Copper
 Lead surface finish : Solder plating
 Molding material : Epoxy resin
 Unit : mm
 Weight : 14mg

Cautions on using this product

- This product contains Gallium-Arsenide (GaAs) which is a harmful material.
- Do NOT eat or put into mouth.
 - Do NOT dispose in fire or break up this product.
 - Do NOT chemically make gas or powder with this product.
 - To waste this product, please obey the relating law of your country.

[CAUTION]

The specifications on this databook are only given for information, without any guarantee as regards either mistakes or omissions. The application circuits in this databook are described only to show representative usages of the product and not intended for the guarantee or permission of any right including the industrial rights.

This product may be damaged with electric static discharge (ESD) or spike voltage. Please handle with care to avoid these damages.