

External 4G/LTE Antenna



AEACBK081014-S698



Ø81.3 x 14.6 mm
RoHS/RoHS II Compliant
MSL = 1

Features

- 4G/LTE full band coverage
- IP67 rated
- Screw mount
- Gain of 3 dBi

Applications

- 4G/LTE/3G/2G radios
- Telematics
- M2M
- IoT and Industrial IoT
- Set top boxes
- Gateway and security
- Transportation and agriculture
- Smart city

Electrical Characteristics

Parameters	Min.	Typ.	Max.	Units	Note
Frequency Range		698-960/1710-2690		MHz	
VSWR			3.0		
Polarization Model	Linear				
Impedance		50		Ω	
Gain		3		dBi	Zenith

Mechanical Characteristics

Parameters	Description
Connector	SMA Male
Cable Type	RG174
Cable Length	3M
Material	ABS
Mount way	Screw
Dimensions	Ø81.3 x 14.6 mm

Environmental Characteristics

Parameters	Description
Waterproof	IP67
Operating Temperature	-40 ~ +85°C
Relative Humidity	Up to 95%
MSL Level	1
ROHS Complaint	Yes
Vibration	10 to 55Hz with 1.5mm amplitude 2 hours

External 4G/LTE Antenna



AEACBK081014-S698



Ø81.3 x 14.6 mm
RoHS/RoHS II Compliant
MSL = 1

Dimensions

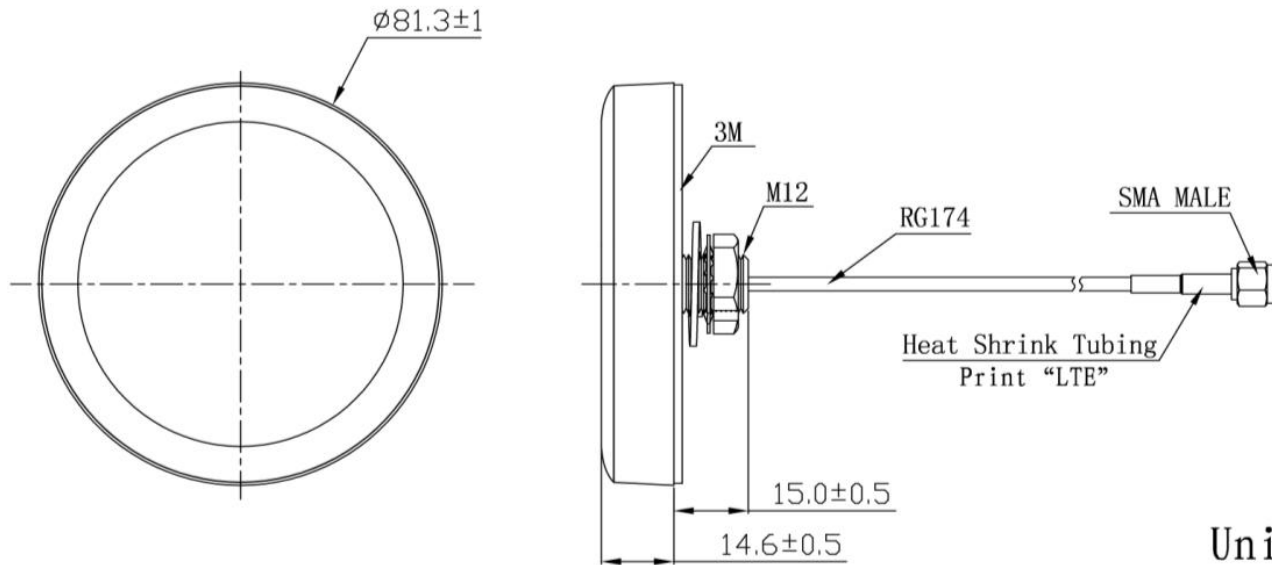

Unit: mm

Product Image



External 4G/LTE Antenna



AEACBK081014-S698



Ø81.3 x 14.6 mm
RoHS/RoHS II Compliant
MSL = 1

VSWR Characteristics

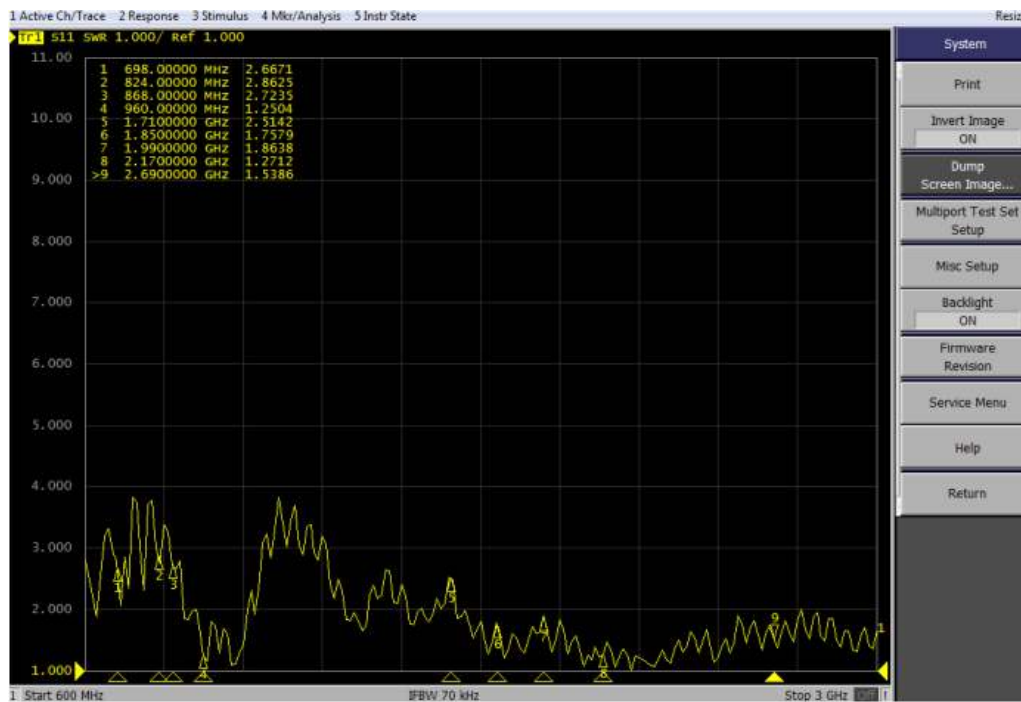

Gain and Efficiency

Frequency (MHz)	Efficiency	Gain (dBi)
700	0.62	1.19
824	0.62	0.98
868	0.68	3.11
960	0.61	0.56
1710	0.53	-3.13
1850	0.57	-2.17
1990	0.63	0.34
2170	0.67	2.57
2690	0.58	-0.69

External 4G/LTE Antenna



AEACBK081014-S698



Ø81.3 x 14.6 mm
RoHS/RoHS II Compliant
MSL = 1

Radiation Patterns

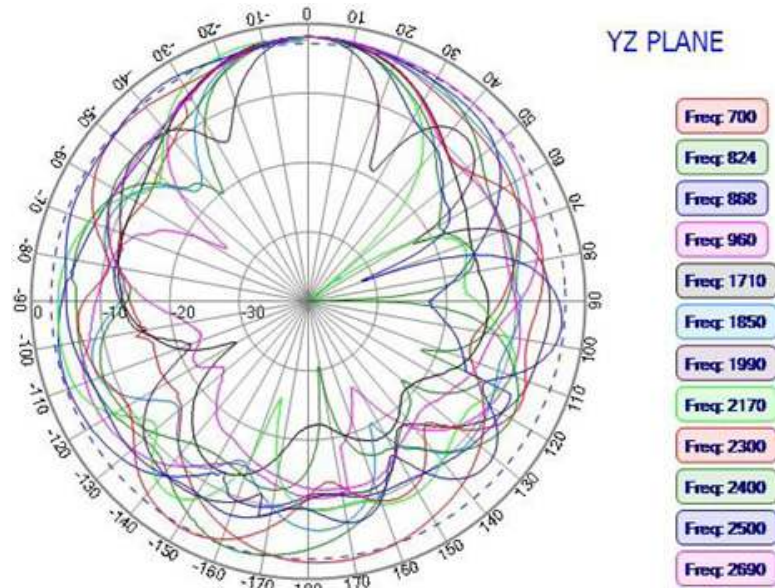
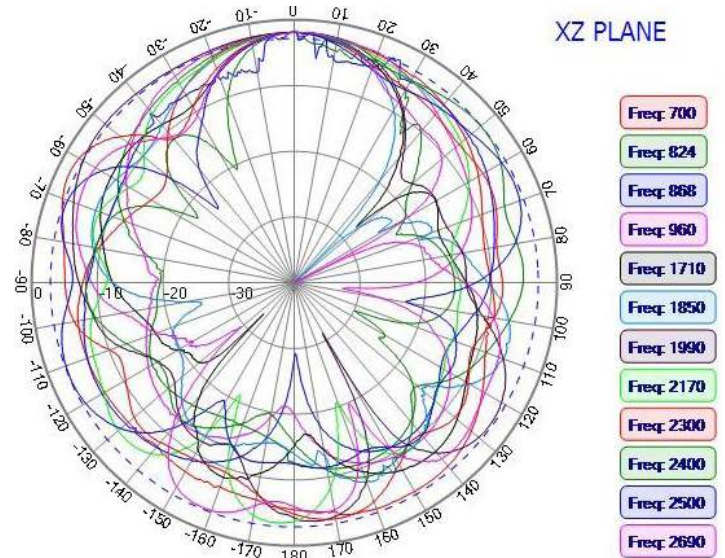
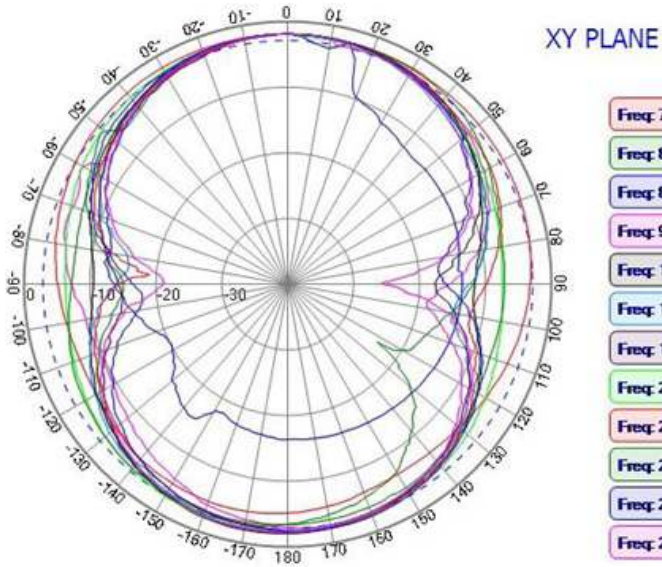

External 4G/LTE Antenna



AEACBK081014-S698



Ø81.3 x 14.6 mm
RoHS/RoHS II Compliant
MSL = 1

3D Radiation Patterns

698 MHz

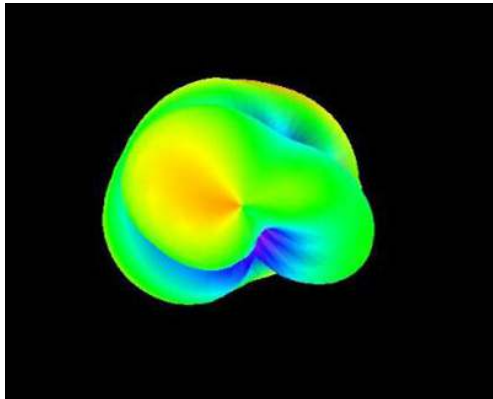

824 MHz

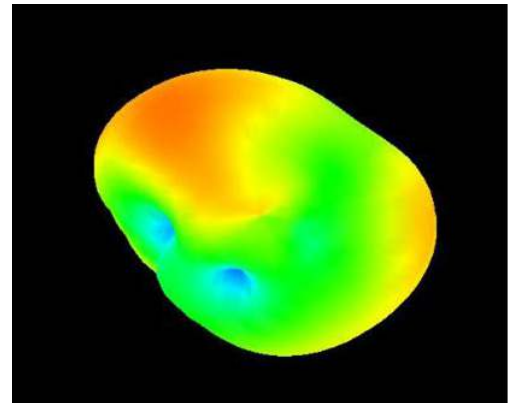

868 MHz

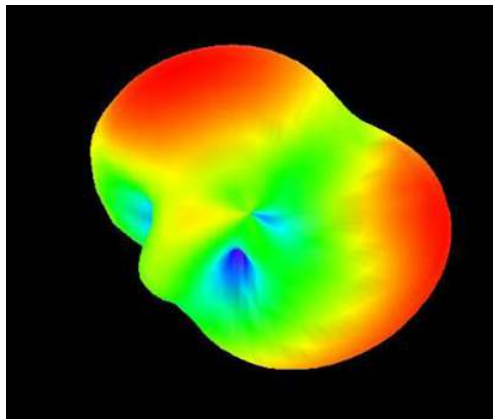

960 MHz

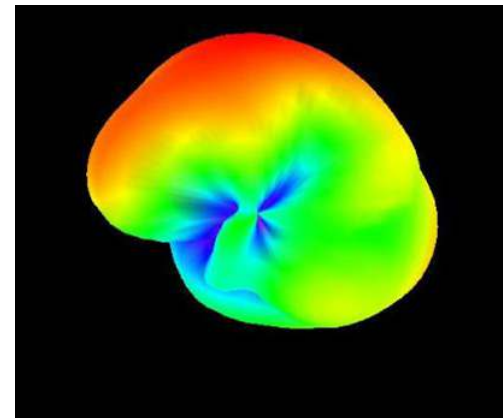

1710 MHz

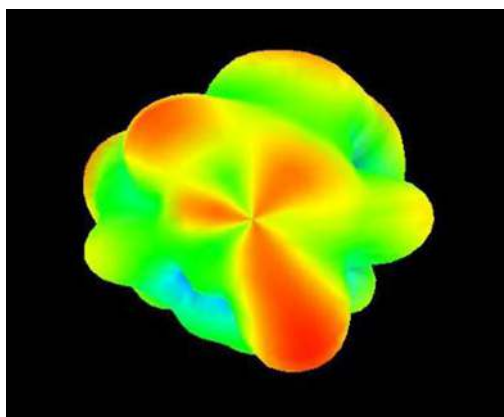

1850 MHz

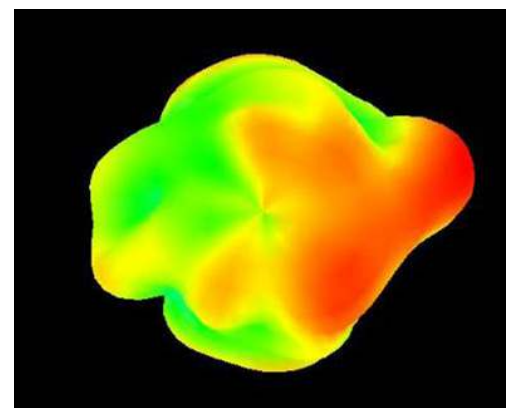

External 4G/LTE Antenna



AEACBK081014-S698



Ø81.3 x 14.6 mm
RoHS/RoHS II Compliant
MSL = 1

3D Radiation Patterns

1990 MHz

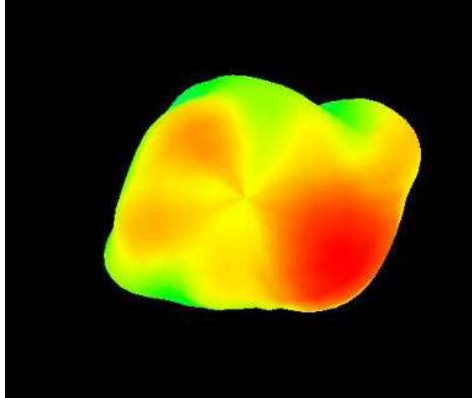

2170 MHz

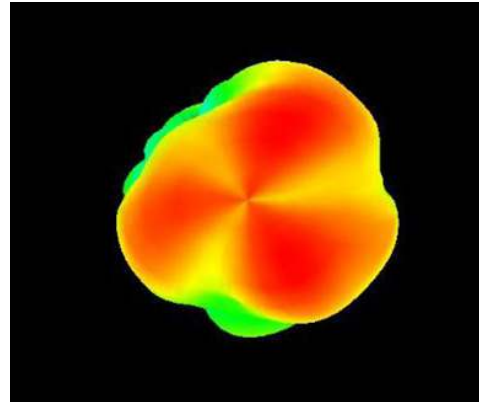

2690 MHz

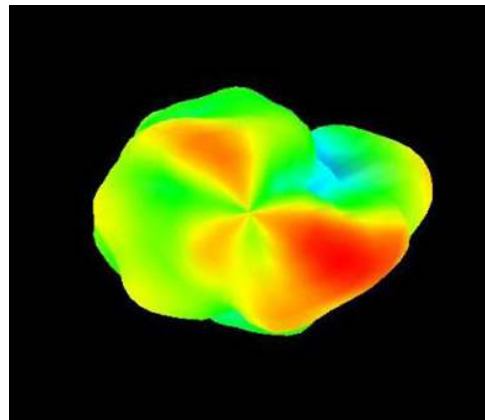

Packaging

Each 49.5 x 22.5 x 27 cm size carton includes 50 pcs antenna, weighs 5 kg.

ATTENTION: Abracon LLC's products are COTS – Commercial-Off-The-Shelf products; suitable for Commercial, Industrial and, where designated, Automotive Applications. Abracon's products are not specifically designed for Military, Aviation, Aerospace, Life-dependent Medical applications or any application requiring high reliability where component failure could result in loss of life and/or property. For applications requiring high reliability and/or presenting an extreme operating environment, written consent and authorization from Abracon LLC is required. Please contact Abracon LLC for more information.



5101 Hidden Creek Ln Spicewood TX 78669
Phone: 512-371-6159 | Fax: 512-351-8858
For terms and conditions of sales, please visit:
www.abracon.com

REVISED: 11.12.2018

ABRACON IS
ISO9001-2015
CERTIFIED