

368544-1 ✓ ACTIVE

## Multilock Connector System

TE Internal #: 368544-1

Wire-to-Wire, 18 Position, White, Signal, Cable Mount (Free-Hanging), Multilock Connector System

[View on TE.com >](#)



Connectors > Automotive Connectors > Automotive Housings > MULTILOCK, CONNECTOR HOUSING

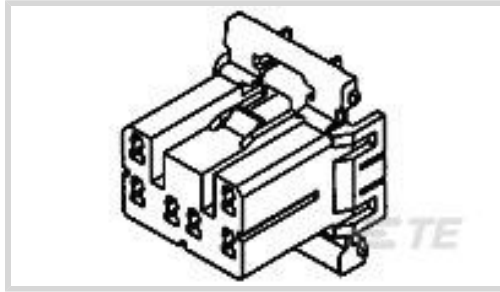

Mating Tab Width: 1.8 mm [ .071 in ]

Connector System: **Wire-to-Wire**

Number of Positions: 18

Sealable: **No**

Hybrid Connector: **No**

[All MULTILOCK, CONNECTOR HOUSING \(567\)](#)

## Features

### Product Type Features

Connector Shape	Rectangular
Connector System	Wire-to-Wire
Sealable	No
Hybrid Connector	No

### Configuration Features

Number of Positions	18
Number of Rows	2

### Body Features

Primary Product Color	White
-----------------------	-------

### Contact Features

Contact Size	1.8mm
Mating Tab Width	1.8 mm[.071 in]

### Mechanical Attachment

Terminal Position Assurance	No
Strain Relief	Without
Mating Alignment Type	Polarized
Mating Alignment	With

Connector Mounting Type	Cable Mount (Free-Hanging)
-------------------------	----------------------------

### Housing Features

Housing Material	PBT GF
------------------	--------

### Dimensions

Connector Height	21.6 mm[.85 in]
------------------	-----------------

Product Width	25.5 mm[1.004 in]
---------------	-------------------

Product Length	42.3 mm[1.665 in]
----------------	-------------------

Row-to-Row Spacing	5.9 mm[.232 in]
--------------------	-----------------

### Operation/Application

Circuit Application	Signal
---------------------	--------

### Packaging Features

Packaging Quantity	150
--------------------	-----

Packaging Method	Bag
------------------	-----

### Other

Connector Position Assurance Capable	No
--------------------------------------	----

## Product Compliance

[For compliance documentation, visit the product page on TE.com>](#)

EU RoHS Directive 2011/65/EU	Compliant
------------------------------	-----------

EU ELV Directive 2000/53/EC	Compliant
-----------------------------	-----------

China RoHS 2 Directive MIIT Order No 32, 2016	No Restricted Materials Above Threshold
---	---

EU REACH Regulation (EC) No. 1907/2006	Current ECHA Candidate List: JUNE 2023 (235) Candidate List Declared Against: JAN 2023 (233) Does not contain REACH SVHC
--	--

Halogen Content	Low Halogen - Br, Cl, F, I < 900 ppm per homogenous material. Also BFR/CFR/PVC Free
-----------------	---

Solder Process Capability	Not applicable for solder process capability
---------------------------	--

#### Product Compliance Disclaimer

This information is provided based on reasonable inquiry of our suppliers and represents our current actual knowledge based on the information they provided. This information is subject to change. The part numbers that TE has identified as EU RoHS compliant have a maximum concentration of 0.1% by weight in homogenous materials for lead, hexavalent chromium, mercury, PBB, PBDE, DBP, BBP, DEHP, DIBP, and 0.01% for cadmium, or qualify for an exemption to these limits as defined in the Annexes of Directive 2011/65/EU (RoHS2). Finished electrical and electronic equipment products will be CE marked as required by Directive 2011/65/EU. Components may not be CE marked. Additionally, the part

numbers that TE has identified as EU ELV compliant have a maximum concentration of 0.1% by weight in homogenous materials for lead, hexavalent chromium, and mercury, and 0.01% for cadmium, or qualify for an exemption to these limits as defined in the Annexes of Directive 2000/53/EC (ELV). Regarding the REACH Regulation, the information TE provides on SVHC in articles for this part number is based on the latest European Chemicals Agency (ECHA) 'Guidance on requirements for substances in articles' posted at this URL: <https://echa.europa.eu/guidance-documents/guidance-on-reach>

## Compatible Parts

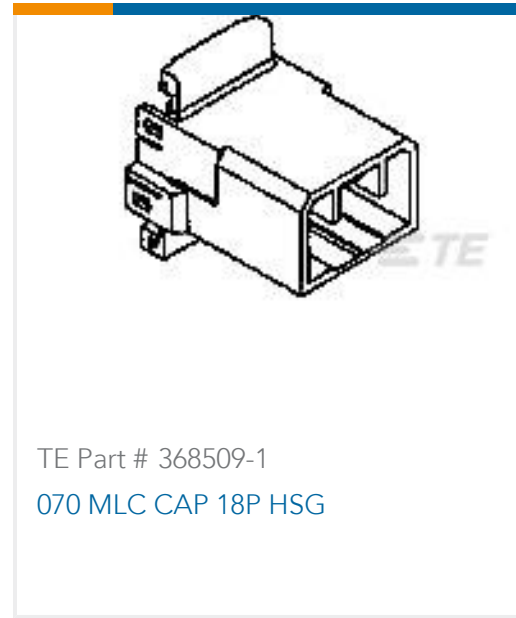

## Also in the Series | Multilock Connector System

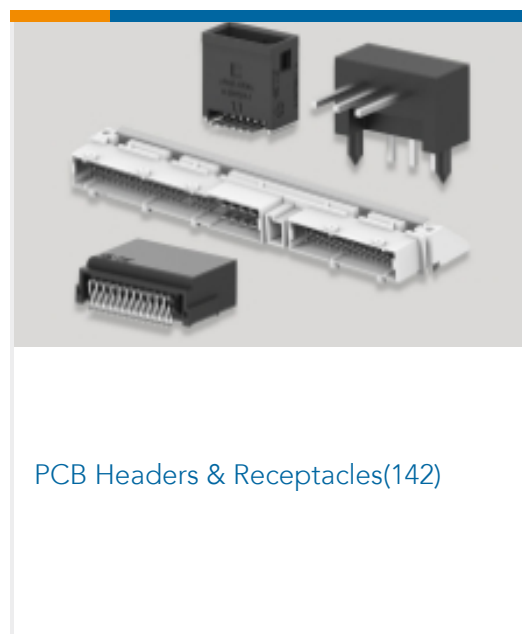
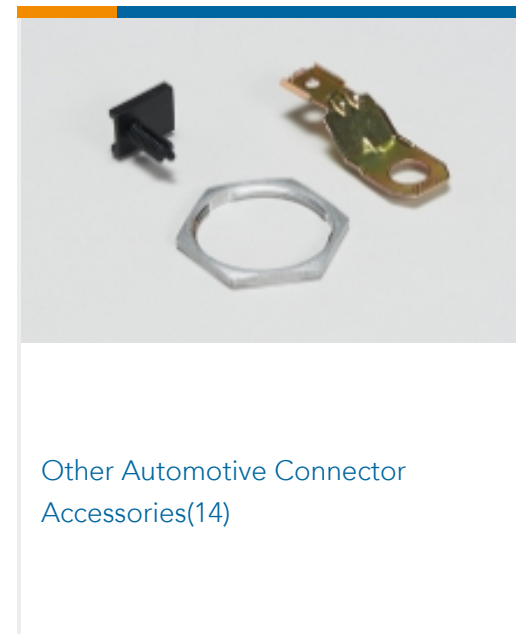
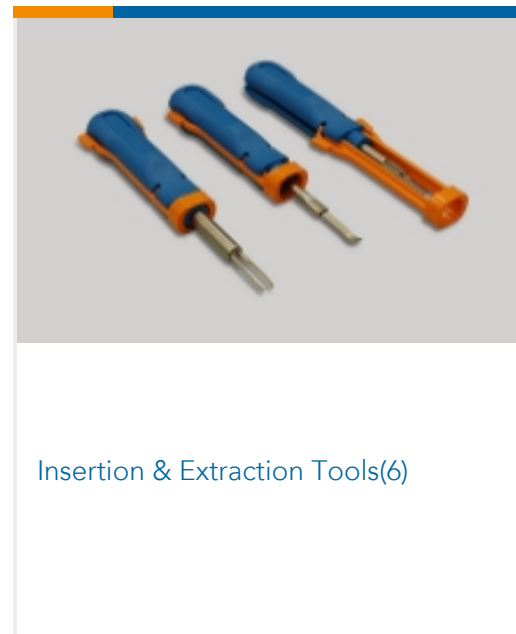
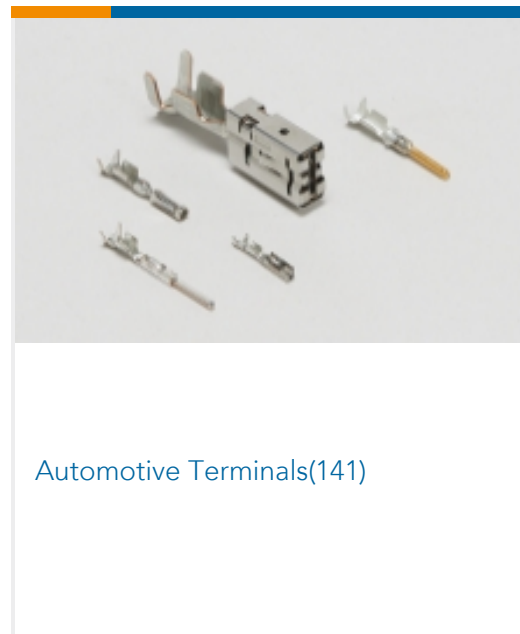
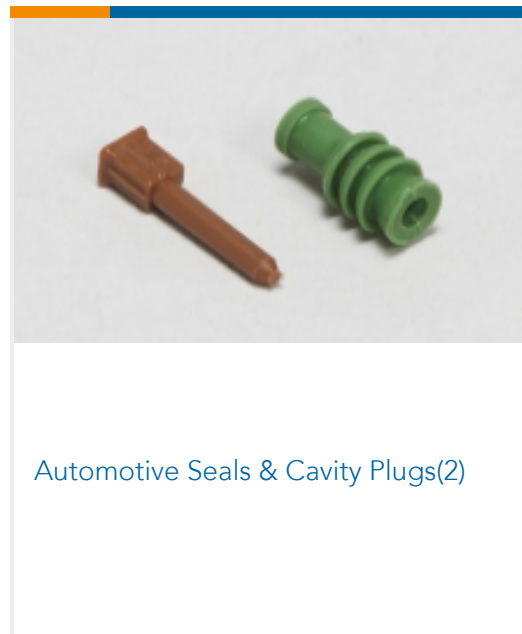
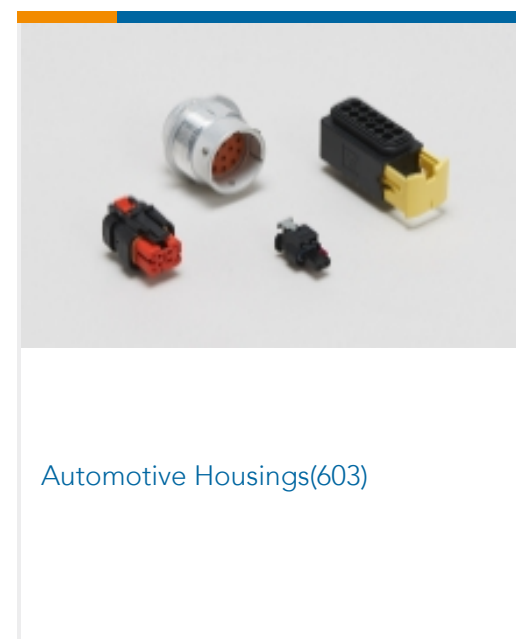
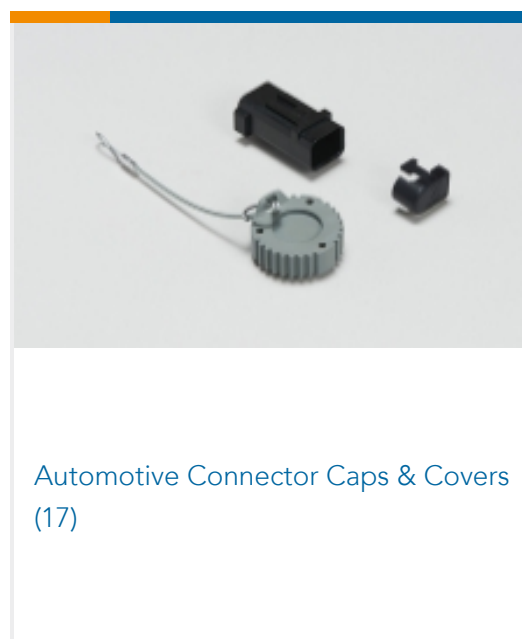

## Customers Also Bought

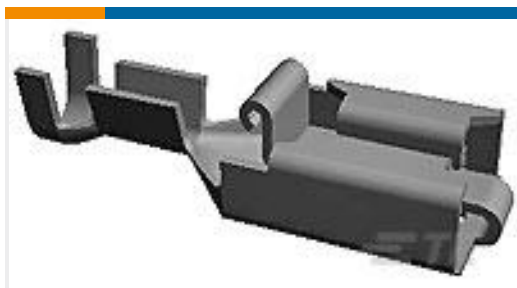

TE Part #160759-4  
PL 250 TERMINAL REC 0.5-1.5 MM2  
TPPHBZ



TE Part #176143-2  
187 CAP HSG ASSY 2P BLACK



TE Part #936224-1  
MULTILOCK, CONNECTOR HOUSING



TE Part #175088-1  
Econoseal Receptacles and Tabs



TE Part #1897214-1  
MCP 6.3 2P PLUG ASSY



TE Part #85011-1  
RUBBER PLUG FOR SEALED CONN.



TE Part #1-1719103-1  
PCB 2.8 TERMINAL SN

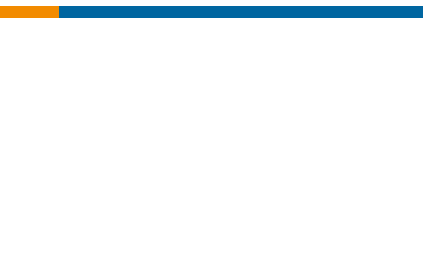

TE Part #2188250-2  
JPT 4P SLD PLUG ASS'Y

## Documents

### Product Drawings

#### 070 MLC PLUG 18P HSG

English

### CAD Files

#### Customer View Model

[ENG\\_CVM\\_CVM\\_368544-1\\_O.2d\\_dxf.zip](#)

English

#### 3D PDF

3D

#### Customer View Model

[ENG\\_CVM\\_CVM\\_368544-1\\_O.3d\\_igs.zip](#)

English

#### Customer View Model

[ENG\\_CVM\\_CVM\\_368544-1\\_O.3d\\_stp.zip](#)

English

By downloading the CAD file I accept and agree to the [Terms and Conditions](#) of use.

### Datasheets & Catalog Pages

#### MULTILOCK Connector System

English

### Product Specifications

#### 070 MLC Series

English

### Agency Approvals

#### UL Report



English