

UCC28060EVM 300-W Interleaved PFC Pre-Regulator

The UCC28060 is a dual-phase, transition-mode Power Factor Correction (PFC) pre-regulator. The UCC28060EVM is an evaluation module (EVM) with a 390-V, 300-W, dc output that operates from a universal input of 85 V_{RMS} to 265 V_{RMS} and provides power-factor correction.

Throughout this document, the acronym *EVM* and the phrases *evaluation board* and *evaluation module* are synonymous with the UCC28060EVM.

1 Description

The pre-regulator uses the [UCC28060 PFC interleaved controller](#) to shape the input current wave to provide power-factor correction. This device uses TI's *Natural Interleaving*[™] technology to interleave boost phases.

This user's guide provides the schematic, List of Materials list, assembly drawing for a single-sided printed circuit board application, and test set-up information necessary to evaluate the UCC28060 in a typical PFC application.

2 Thermal Requirements

This evaluation module will operate up to 300 W without external cooling in ambient temperatures of 25°C.

3 Electrical Characteristics

[Table 1](#) summarizes the electrical specifications of the UCC28060EVM.

Table 1. UCC28060EVM Electrical Specifications

PARAMETER	CONDITIONS	UCC28060EVM			UNITS
		MIN	TYP	MAX	
RMS input voltage (ac line)		85		265	V _{RMS}
Output voltage, V _{OUT}			390		V
Line frequency		47		63	Hz
Power factor (PF) at maximum load		0.9			
Output power				300	W
Full load efficiency	AC line = 115 V		94%		
	AC line = 230 V		97%		

Natural Interleaving is a trademark of Texas Instruments.
All other trademarks are the property of their respective owners.

4 Schematics

Figure 1 and Figure 2 show the schematics for this EVM. See the [List of Materials](#) for specific values.

To evaluate inductor ripple currents, Jumpers JP8 and JP9 can be removed and replaced with current loops.

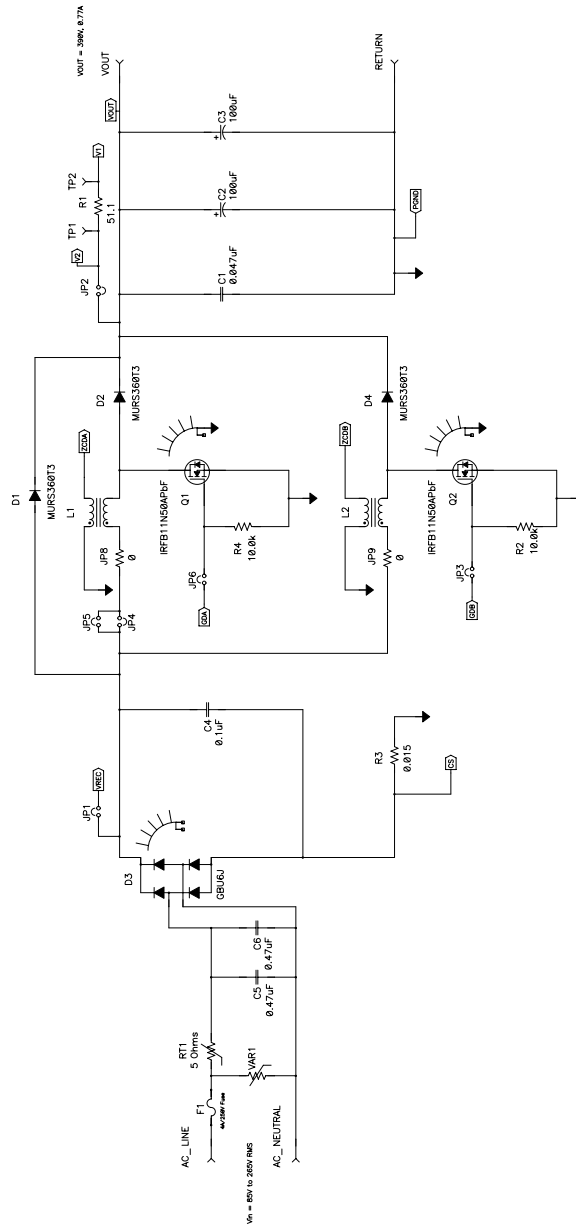

Figure 1. Interleaved PFC Power Stage

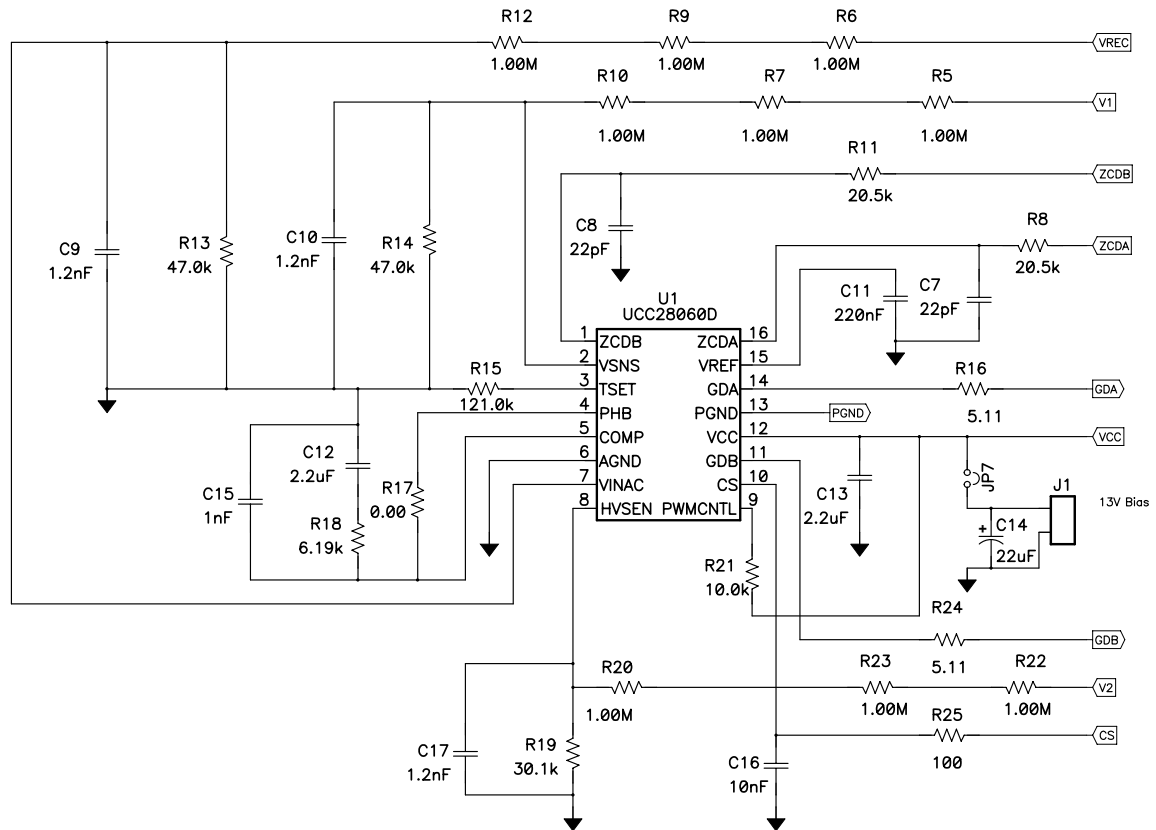

Figure 2. Controller Circuitry

5 Test Setup and Power-Up/Power-Down Instructions

WARNING

There are high voltages present on the pre-regulator. It should only be handled by experienced power supply professionals. To evaluate this board as safely as possible, the following test configuration should be used:

- Connect an isolation transformer between the source and unit
- Attach a voltmeter and a resistive or electronic load to the unit output **before** supplying power to the EVM.

A separate 13-V bias supply is required to power the UCC28060 control circuitry. The unit will start up under no-load conditions. However, for safety, a load should be connected to the output of the device before it is powered up. The unit should also never be handled while power is applied to it or when the output voltage is above 50-V dc. Refer to [Figure 3](#) for a recommended test setup diagram.

CAUTION

There are very high voltages on the board. Components can and will reach temperatures greater than 100°C. Use caution when handling the EVM.

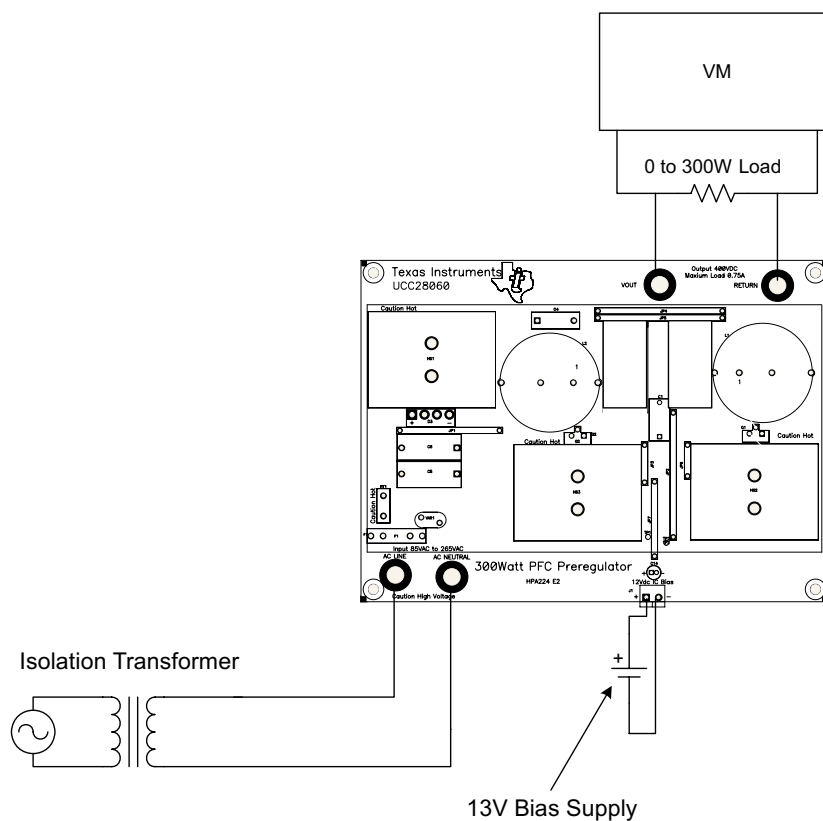

Figure 3. Test Setup

6 Typical Performance Data

Figure 4 through Figure 7 present characteristic performance data for the UCC28060EVM.

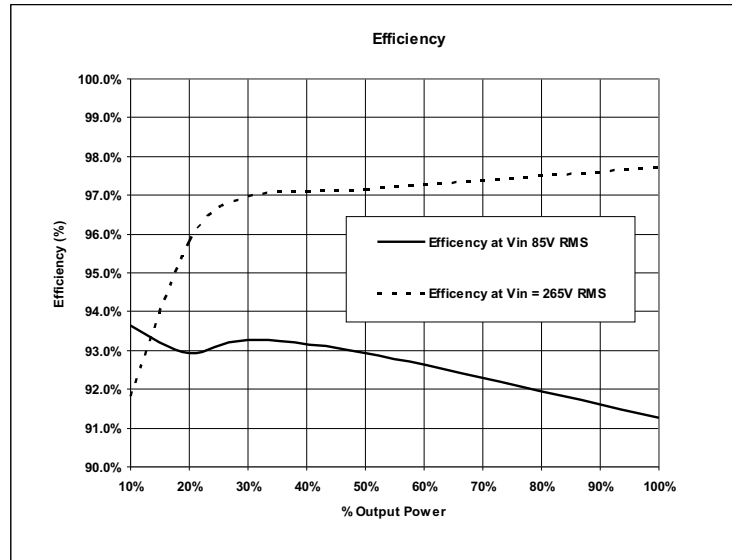

Figure 4. Efficiency at 85V_{RMS} and 265V_{RMS}

The UCC28060 control device has phase management capability to improve light load efficiency. To demonstrate the light load efficiency, the unit efficiency was measured with phase management enabled and disabled at 115 V_{RMS} and 230 V_{RMS} input voltages. Phase management improved the light load efficiency up to 3%. Refer to the [UCC28060 data sheet](#) for details on how to use the phase management function of this device.

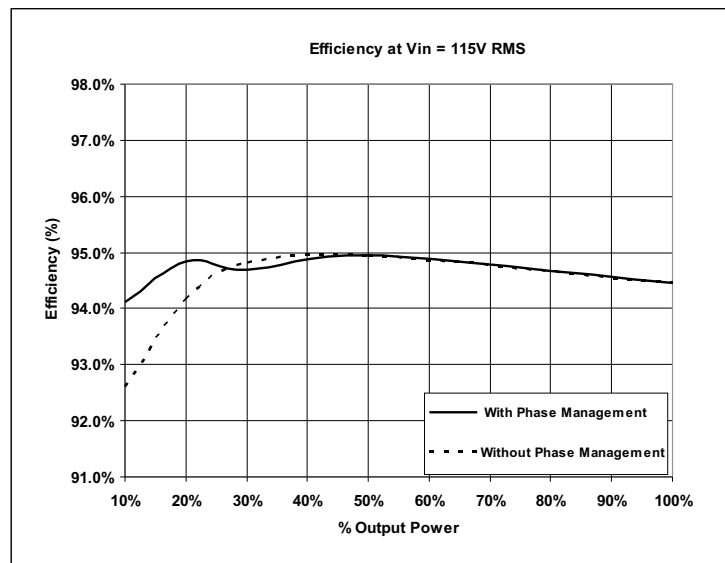

Figure 5. Efficiency at 115 V_{RMS}, With and Without Phase Management

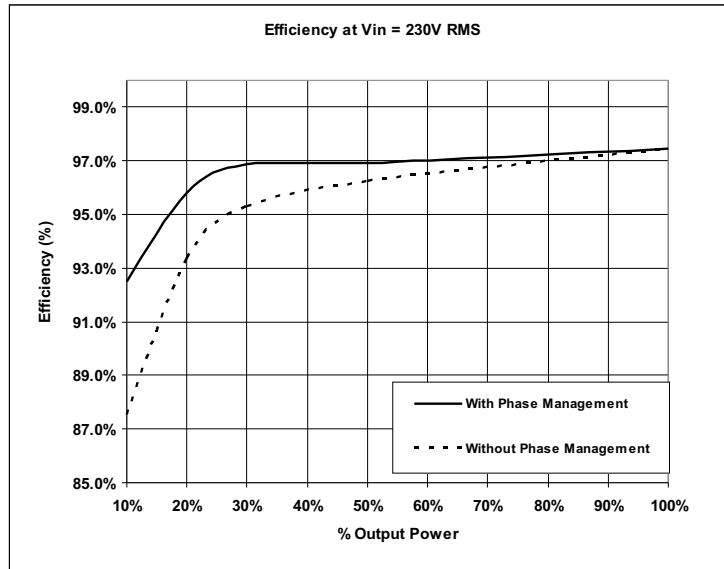

Figure 6. Efficiency at 230 V_{RMS}, With and Without Phase Management

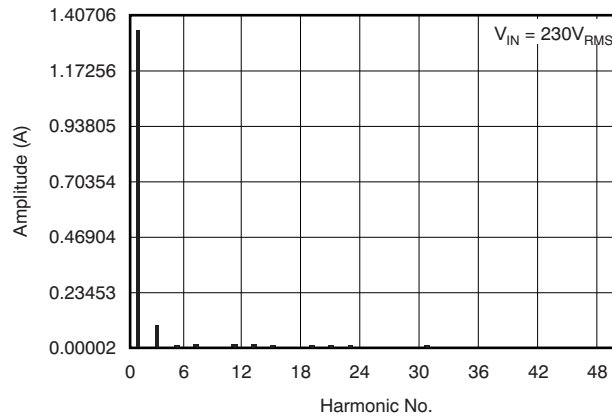

Figure 7. Current Harmonics

6.1 Output Ripple Voltage at Full Load

Figure 8 illustrates the output ripple voltage.

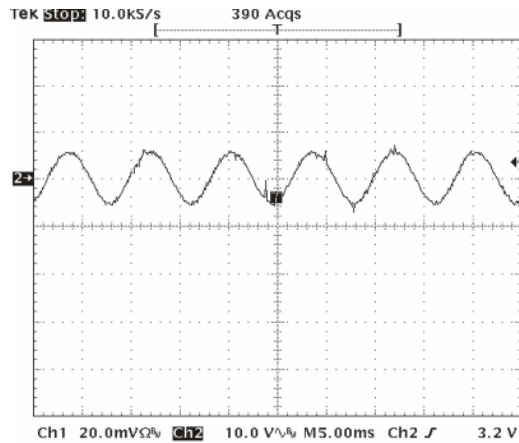

Figure 8. V_{OUT} Ripple, $P_{OUT} = 300\text{ W}$

6.2 Input Ripple Current Cancellation

Figure 9 through Figure 14 show the input current ($M_1 = I_{L1} + I_{L2}$), Inductor Ripple Current (I_{L1} , I_{L2}) versus rectified line voltage. From these graphs, it can be observed that interleaving reduces the magnitude of input ripple current caused by the inductor ripple current.

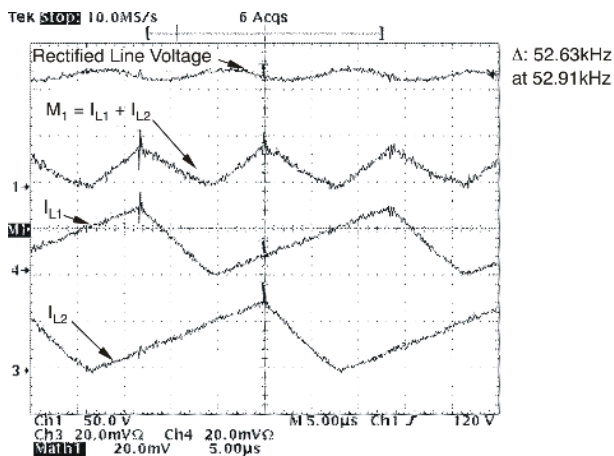

Figure 9. Inductor and Input Ripple Current at 85 V_{RMS} at Peak of Line Voltage

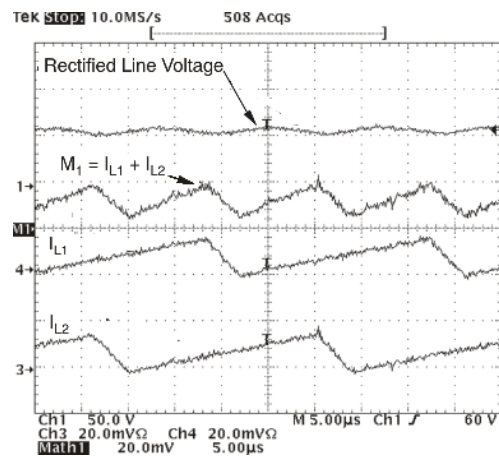

Figure 10. Inductor and Input Ripple Current at 85 V_{RMS} Input at Half the Line Voltage

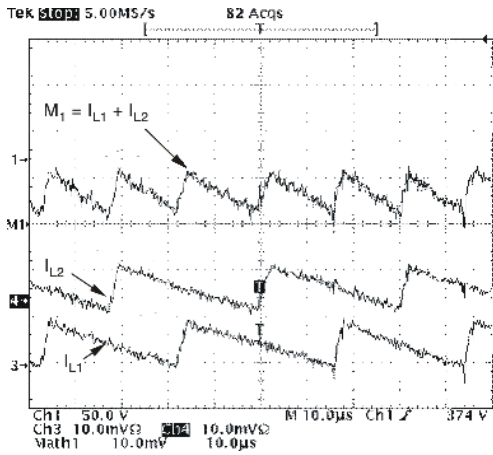

Figure 11. Inductor and Input Ripple Current at 265 V_{RMS} Input at Peak Line Voltage

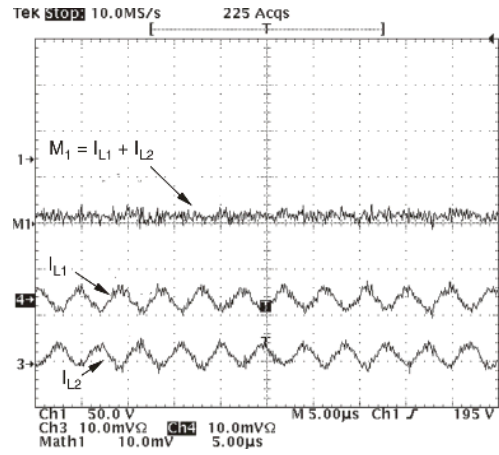

Figure 12. Inductor and Input Ripple Current at 265 V_{RMS} Input at Half Peak Line Voltage

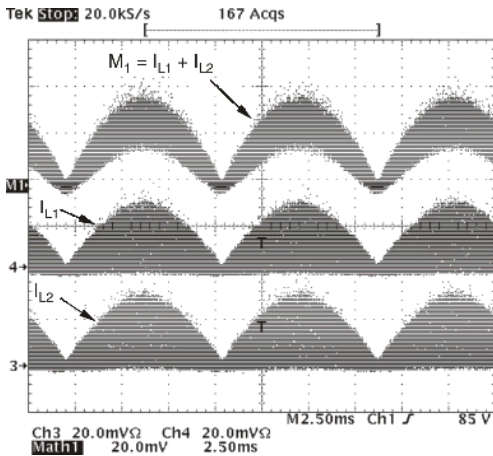

Figure 13. Inductor and Input Ripple Current at $V_{IN} = 85 V_{RMS}$, $P_{OUT} = 300 W$

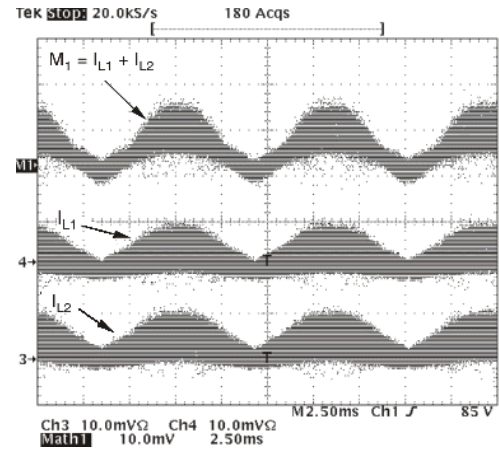

Figure 14. Inductor and Input Ripple Current at $V_{IN} = 265 V_{RMS}$, $P_{OUT} = 350 W$

6.3 Startup Characteristics

Figure 15 and Figure 16 illustrate the UCC28060EVM startup characteristics.

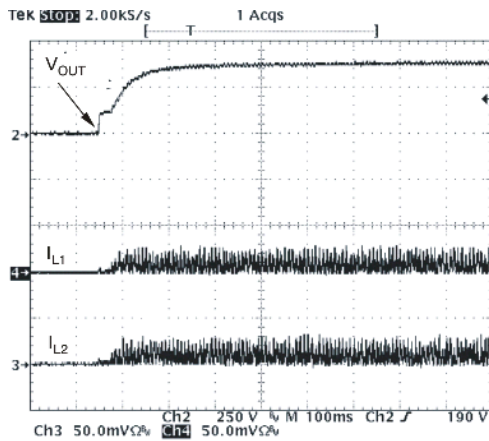

Figure 15. Start-Up at $V_{IN} = 85 V_{RMS}$, $P_{OUT} = 350 W$

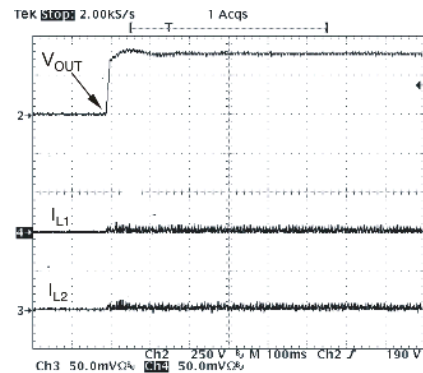

Figure 16. Start-Up at $V_{IN} = 265 V_{RMS}$, $P_{OUT} = 0 W$

6.4 Brownout Protection

The UCC28060 has a brownout protection that shuts down both gate drives (GDA and GDB) when the VINAC pin detects that the RMS input voltage is too low. This EVM was designed to go into a brownout state when the line drops below $64 V_{RMS}$. Once the UCC28060 control device has determined that the input is in a brownout condition, a 400-ms timer starts to allow the line to recover before shutting down the gate drivers. After 400 ms of brownout, both gate drivers turn off, as shown in Figure 17 and Figure 18.

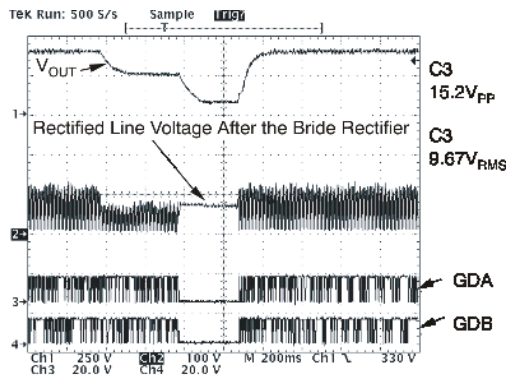

Figure 17. Brownout at $85 V_{RMS}$

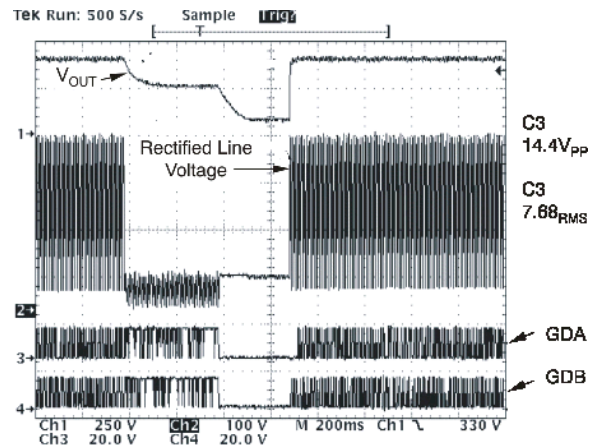

Figure 18. Brownout at $265 V_{RMS}$

6.5 Line Transient

A line transient test was conducted with an ac source on the reference design. The line was varied from 230 V_{RMS} to 115 V_{RMS} to 230 V_{RMS} and the transient response was evaluated in each case. From the oscilloscope image in Figure 19, it can be observed that the output recovered from line transients within 300ms at full load.

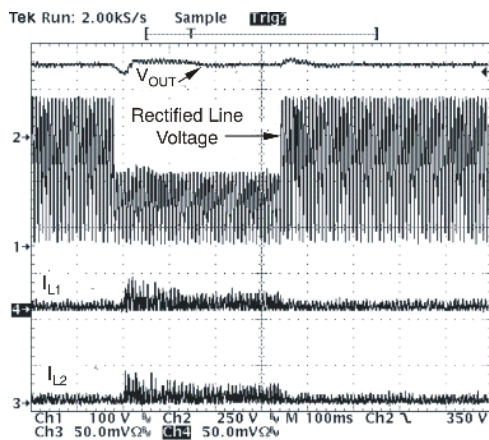

Figure 19. Line Transient, P_{OUT} = 300W

7 Reference Design Assembly Drawing

Figure 20 and Figure 22 show the top and bottom layers (respectively) of the UCC28060EVM.

Note: Board layouts are not to scale. These figures are intended to show how the board is laid out; they are not intended to be used for manufacturing UCC28060EVM PCBs.

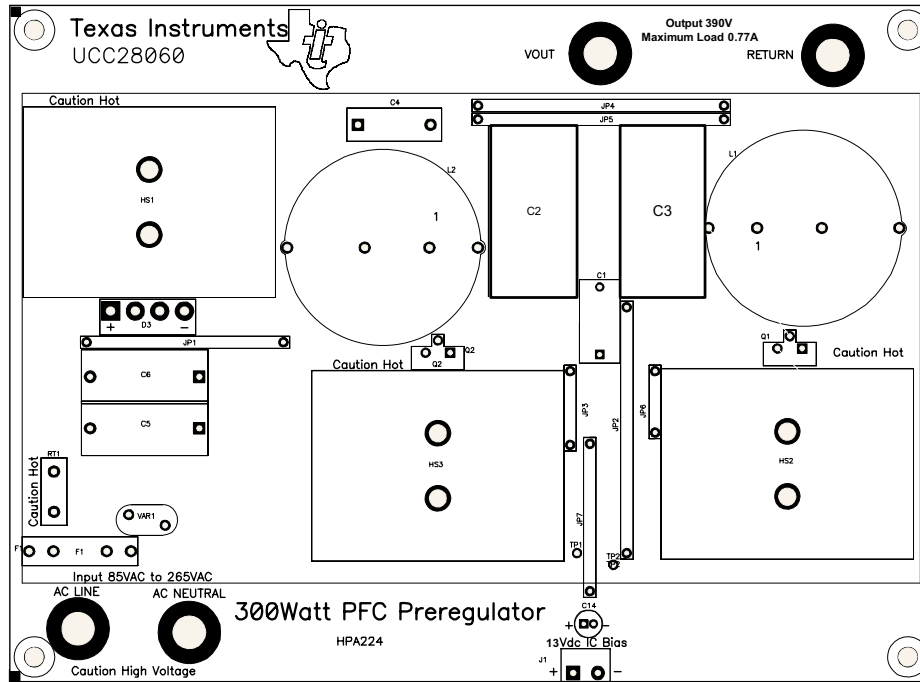

Figure 20. Top Layer Assembly

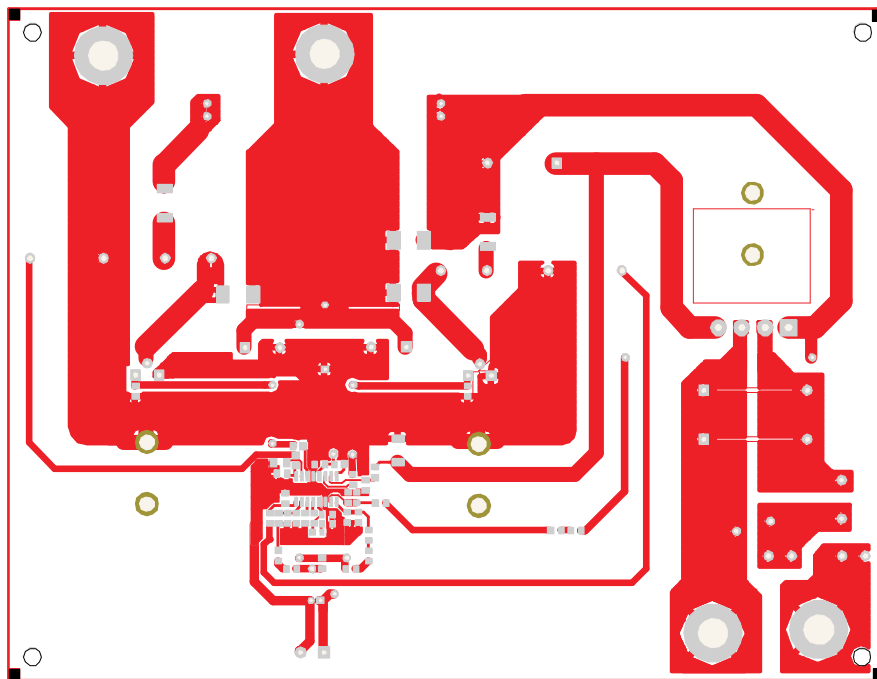

Figure 21. Bottom Layer Copper

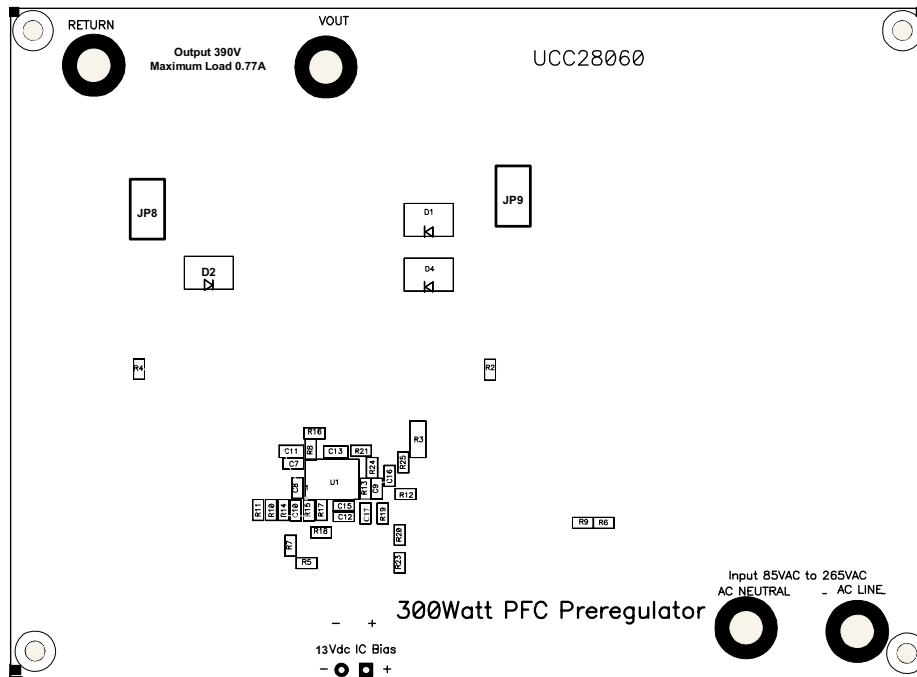

Figure 22. Bottom Layer Assembly

8 List of Materials

Table 2 lists the EVM components as configured according to the schematics (see Section 4).

Table 2. List of Materials

Qty	RefDes	Value	Description	Size	Part Number	MFR
4	AC_LINE, AC_NEUTRAL, VOUT, RETURN	3267	Connector, Banana Jack, Uninsulated	0.500 dia. inch	3267	Pomona
1	C1	0.047 μ F	Capacitor, Polyester, 630V, 10%	0.256in \times 0.650in	ECQ-E6473KZ	Panasonic
1	C11	220nF	Capacitor, Ceramic, 16V, X7R, 10%	1206	Std	Std
2	C12, C13	2.2 μ F	Capacitor, Ceramic, 16V, X7R, 10%	0805	Std	Std
1	C14	22 μ F	Capacitor, Aluminum, 35V, \pm 20%	0.200in \times 0.435in	ECA-1VM220	Panasonic
1	C15	1nF	Capacitor, Ceramic, 25V, X7R, 10%	0805	Std	Std
1	C16	10nF	Capacitor, Ceramic, 25V, X7R, 10%	0805	Std	Std
2	C2, C3	100 μ F	Capacitor, Aluminum, 450VDC, \pm 20%	18mm \times 40 mm	EKXG451ELL101 MM40S	Nippon Chemicon
1	C4	0.1 μ F	Capacitor, Film, 275VAC, \pm 20%	0.689in \times 0.236in	ECQU2A104BC1	Panasonic
2	C5, C6	0.47 μ F	Capacitor, Film, 275VAC, \pm 20%	0.236 \times 0.591	ECQ-U2A474MG	Panasonic
2	C7, C8	22pF	Capacitor, Ceramic, 25V, X7R, 10%	0805	Std	Std
3	C9, C10, C17	1.2nF	Capacitor, Ceramic, 25V, X7R, 10%	0805	Std	Std
3	D1, D2, D4	MURS360T3	Diode, 3000mA, 600V	SMC	MURS360T3	On Semi
1	D3	GBU6J	Diode, Bridge, 6A, 600V	BU6	GBU6J	Vishay
2	F1	0100056H	Fuse Clip, 5mm \times 20mm	0.205in \times 0.220in x2	0100056H	Wickmann
1	F1	BK/GDA-4A	4A, Fast Acting Fuse	5mm \times 20mm	BK/S501-4-R	Cooper/ Bussman
3	HS1, HS2, HS3	7-345-2PP	Heatsink, Universal-mount TO-220	1.500in \times 2.000in	7-345-2PP	IERC-CTS
1	J1	ED1609-ND	Terminal Block, 2-pin, 15-A, 5.1mm	0.40in \times 0.35in	ED1609	OST

Table 2. List of Materials (continued)

Qty	RefDes	Value	Description	Size	Part Number	MFR
1	JP1	923345-20-C	Jumper, 1.600 inch length, PVC Insulation, AWG 22	0.035in dia.	Cut to Dimension	3M
3	JP2, JP4, JP5	923345-20-C	Jumper, 2.000 inch length, PVC Insulation, AWG 22	0.035in dia.	923345-20-C	3M
1	JP3	923345-06-C	Jumper, 0.600 inch length, PVC Insulation, AWG 22	0.035in dia.	923345-06-C	3M
1	JP6	923345-05-C	Jumper, 0.500 inch length, PVC Insulation, AWG 22	0.035in dia.	923345-05-C	3M
1	JP7	923345-20-C	Jumper, 1.200 inch length, PVC Insulation, AWG 22	0.035in dia.	Cut to Dimension	3M
2	JP8, JP9	0	Resistor, Chip, 1W, 5%	2512	Std	Std
1	PCB		HPA224 Printed Circuit Board			
2	L1, L2	CTX16-17769R	Inductor, Boost PFC With Aux. 330μH at 5.3 A PK	1.555in dia.	CTX16-17769R	Cooper
2	Q1, Q2	IRFB11N50APbF	MOSFET, N-ch, 500V, 11A, 520mΩ	TO-220V	IRFB11N50APbF	IR
1	R1	51.1	Resistor, Chip, 1/10W, 1%	0805	Std	Std
2	R13, R14	47.0k	Resistor, Chip, 1/10W, 1%	0805	Std	Std
1	R15	121.0k	Resistor, Chip, 1/10W, 1%	0805	Std	Std
2	R16, R24	5.11	Resistor, Chip, 1/10W, 1%	0805	Std	Std
1	R17	0.00	Resistor, Chip, 1/10W, 1%	0805	Std	Std
1	R18	6.19k	Resistor, Chip, 1/10W, 1%	0805	Std	Std
1	R19	30.1k	Resistor, Chip, 1/10W, 1%	0805	Std	Std
3	R2, R4, R21	10.0k	Resistor, Chip, 1/10W, 1%	0805	Std	Std
1	R25	100	Resistor, Chip, 1/10W, 1%	0805	Std	Std
1	R3	0.015	Resistor, Chip, 1/2W, 1%	2010	WSL2010R0150F EA	Vishay
9	R5–R9, R10, R12, R20, R22, R23	1.00M	Resistor, Chip, 1/10W, 1%	0805	Std	Std
2	R8, R11	20.5k	Resistor, Chip, 1/10W, 1%	0805	Std	Std
1	RT1	5Ω	Thermistor, NTC, 5Ω, 6A	0.180in × 0.550in	CL-40	Thermometrics
2	TP1, TP2	K24A/M	Pin, Thru Hole, Tin Plate, for 0.062 PCBs	0.039in	K24A/M	Vector
1	U1	UCC28060D	IC, Interleave PFC Controller	SO16	UCC28060D	TI
1	VAR1	SIOV-S10K275E2	VARISTOR 275V RMS	0.472in × 0.213in	S10K275E2	Epcos
6	X1 at HS1 and D3, HS2 and Q1, HS3 and Q2		Nut #4-40 (steel)		Std	Std
6	X1 at HS1 and D3, HS2 and Q1, HS3 and Q2		Pan Head Screw #4-40X3/8 (steel)		Std	Std
1	X1 D3 and HS1		Thermal Grease		Std	Std
6	X1 at HS1 and D3, HS2 and Q1, HS3 and Q2		Split Lock Washer #4(steel)		Std	Std
6	X1 at HS1 and D3, HS2 and Q1, HS3 and Q2		Nylon Shoulder Washer #4		3049	Keystone Electronics
2	X1 at HS2 and Q1, HS3 and Q2		Thermal Pad Silicon TO220		3223-07FR-51	BERQUIST

EVALUATION BOARD/KIT IMPORTANT NOTICE

Texas Instruments (TI) provides the enclosed product(s) under the following conditions:

This evaluation board/kit is intended for use for **ENGINEERING DEVELOPMENT, DEMONSTRATION, OR EVALUATION PURPOSES ONLY** and is not considered by TI to be a finished end-product fit for general consumer use. Persons handling the product(s) must have electronics training and observe good engineering practice standards. As such, the goods being provided are not intended to be complete in terms of required design-, marketing-, and/or manufacturing-related protective considerations, including product safety and environmental measures typically found in end products that incorporate such semiconductor components or circuit boards. This evaluation board/kit does not fall within the scope of the European Union directives regarding electromagnetic compatibility, restricted substances (RoHS), recycling (WEEE), FCC, CE or UL, and therefore may not meet the technical requirements of these directives or other related directives.

Should this evaluation board/kit not meet the specifications indicated in the User's Guide, the board/kit may be returned within 30 days from the date of delivery for a full refund. **THE FOREGOING WARRANTY IS THE EXCLUSIVE WARRANTY MADE BY SELLER TO BUYER AND IS IN LIEU OF ALL OTHER WARRANTIES, EXPRESSED, IMPLIED, OR STATUTORY, INCLUDING ANY WARRANTY OF MERCHANTABILITY OR FITNESS FOR ANY PARTICULAR PURPOSE.**

The user assumes all responsibility and liability for proper and safe handling of the goods. Further, the user indemnifies TI from all claims arising from the handling or use of the goods. Due to the open construction of the product, it is the user's responsibility to take any and all appropriate precautions with regard to electrostatic discharge.

EXCEPT TO THE EXTENT OF THE INDEMNITY SET FORTH ABOVE, NEITHER PARTY SHALL BE LIABLE TO THE OTHER FOR ANY INDIRECT, SPECIAL, INCIDENTAL, OR CONSEQUENTIAL DAMAGES.

TI currently deals with a variety of customers for products, and therefore our arrangement with the user **is not exclusive.**

TI assumes **no liability for applications assistance, customer product design, software performance, or infringement of patents or services described herein.**

Please read the User's Guide and, specifically, the Warnings and Restrictions notice in the User's Guide prior to handling the product. This notice contains important safety information about temperatures and voltages. For additional information on TI's environmental and/or safety programs, please contact the TI application engineer or visit www.ti.com/esh.

No license is granted under any patent right or other intellectual property right of TI covering or relating to any machine, process, or combination in which such TI products or services might be or are used.

FCC Warning

This evaluation board/kit is intended for use for **ENGINEERING DEVELOPMENT, DEMONSTRATION, OR EVALUATION PURPOSES ONLY** and is not considered by TI to be a finished end-product fit for general consumer use. It generates, uses, and can radiate radio frequency energy and has not been tested for compliance with the limits of computing devices pursuant to part 15 of FCC rules, which are designed to provide reasonable protection against radio frequency interference. Operation of this equipment in other environments may cause interference with radio communications, in which case the user at his own expense will be required to take whatever measures may be required to correct this interference.

EVM WARNINGS AND RESTRICTIONS

It is important to operate this EVM within the input voltage range of 85V_{RMS} to 265V_{RMS} and the output voltage range of 375V to 450V.

Exceeding the specified input range may cause unexpected operation and/or irreversible damage to the EVM. If there are questions concerning the input range, please contact a TI field representative prior to connecting the input power.

Applying loads outside of the specified output range may result in unintended operation and/or possible permanent damage to the EVM. Please consult the EVM User's Guide prior to connecting any load to the EVM output. If there is uncertainty as to the load specification, please contact a TI field representative.

During normal operation, some circuit components may have case temperatures greater than +100°C. The EVM is designed to operate properly with certain components above +100°C as long as the input and output ranges are maintained. These components include but are not limited to linear regulators, switching transistors, pass transistors, and current sense resistors. These types of devices can be identified using the EVM schematic located in the EVM User's Guide. When placing measurement probes near these devices during operation, please be aware that these devices may be very warm to the touch.

Mailing Address: Texas Instruments, Post Office Box 655303, Dallas, Texas 75265
Copyright © 2008, Texas Instruments Incorporated

IMPORTANT NOTICE

Texas Instruments Incorporated and its subsidiaries (TI) reserve the right to make corrections, modifications, enhancements, improvements, and other changes to its products and services at any time and to discontinue any product or service without notice. Customers should obtain the latest relevant information before placing orders and should verify that such information is current and complete. All products are sold subject to TI's terms and conditions of sale supplied at the time of order acknowledgment.

TI warrants performance of its hardware products to the specifications applicable at the time of sale in accordance with TI's standard warranty. Testing and other quality control techniques are used to the extent TI deems necessary to support this warranty. Except where mandated by government requirements, testing of all parameters of each product is not necessarily performed.

TI assumes no liability for applications assistance or customer product design. Customers are responsible for their products and applications using TI components. To minimize the risks associated with customer products and applications, customers should provide adequate design and operating safeguards.

TI does not warrant or represent that any license, either express or implied, is granted under any TI patent right, copyright, mask work right, or other TI intellectual property right relating to any combination, machine, or process in which TI products or services are used. Information published by TI regarding third-party products or services does not constitute a license from TI to use such products or services or a warranty or endorsement thereof. Use of such information may require a license from a third party under the patents or other intellectual property of the third party, or a license from TI under the patents or other intellectual property of TI.

Reproduction of TI information in TI data books or data sheets is permissible only if reproduction is without alteration and is accompanied by all associated warranties, conditions, limitations, and notices. Reproduction of this information with alteration is an unfair and deceptive business practice. TI is not responsible or liable for such altered documentation. Information of third parties may be subject to additional restrictions.

Resale of TI products or services with statements different from or beyond the parameters stated by TI for that product or service voids all express and any implied warranties for the associated TI product or service and is an unfair and deceptive business practice. TI is not responsible or liable for any such statements.

TI products are not authorized for use in safety-critical applications (such as life support) where a failure of the TI product would reasonably be expected to cause severe personal injury or death, unless officers of the parties have executed an agreement specifically governing such use. Buyers represent that they have all necessary expertise in the safety and regulatory ramifications of their applications, and acknowledge and agree that they are solely responsible for all legal, regulatory and safety-related requirements concerning their products and any use of TI products in such safety-critical applications, notwithstanding any applications-related information or support that may be provided by TI. Further, Buyers must fully indemnify TI and its representatives against any damages arising out of the use of TI products in such safety-critical applications.

TI products are neither designed nor intended for use in military/aerospace applications or environments unless the TI products are specifically designated by TI as military-grade or "enhanced plastic." Only products designated by TI as military-grade meet military specifications. Buyers acknowledge and agree that any such use of TI products which TI has not designated as military-grade is solely at the Buyer's risk, and that they are solely responsible for compliance with all legal and regulatory requirements in connection with such use.

TI products are neither designed nor intended for use in automotive applications or environments unless the specific TI products are designated by TI as compliant with ISO/TS 16949 requirements. Buyers acknowledge and agree that, if they use any non-designated products in automotive applications, TI will not be responsible for any failure to meet such requirements.

Following are URLs where you can obtain information on other Texas Instruments products and application solutions:

Products

Amplifiers	amplifier.ti.com
Data Converters	dataconverter.ti.com
DSP	dsp.ti.com
Clocks and Timers	www.ti.com/clocks
Interface	interface.ti.com
Logic	logic.ti.com
Power Mgmt	power.ti.com
Microcontrollers	microcontroller.ti.com
RFID	www.ti-rfid.com
RF/IF and ZigBee® Solutions	www.ti.com/lprf

Applications

Audio	www.ti.com/audio
Automotive	www.ti.com/automotive
Broadband	www.ti.com/broadband
Digital Control	www.ti.com/digitalcontrol
Medical	www.ti.com/medical
Military	www.ti.com/military
Optical Networking	www.ti.com/opticalnetwork
Security	www.ti.com/security
Telephony	www.ti.com/telephony
Video & Imaging	www.ti.com/video
Wireless	www.ti.com/wireless

Mailing Address: Texas Instruments, Post Office Box 655303, Dallas, Texas 75265
Copyright © 2008, Texas Instruments Incorporated