



# STTA9012TV1/2

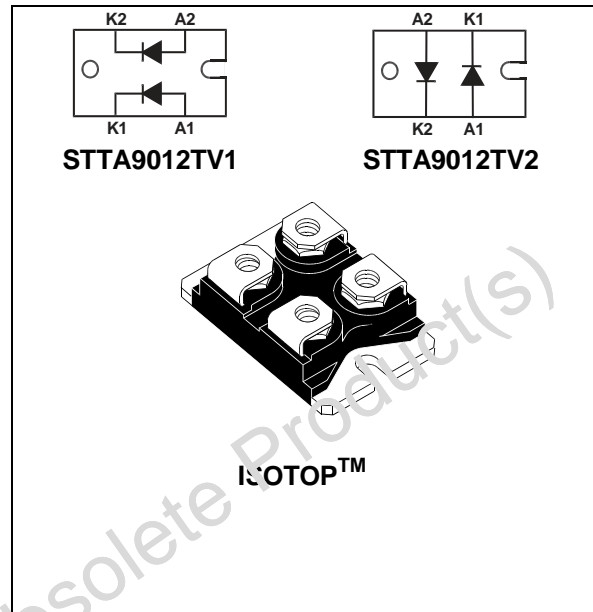
## TURBOSWITCH™ ULTRA-FAST HIGH VOLTAGE DIODE

### MAIN PRODUCT CHARACTERISTICS

$I_{F(AV)}$	2 x 45A
$V_{RRM}$	1200V
$t_{rr} (typ)$	65ns
$V_F (max)$	1.85V

### FEATURES AND BENEFITS

- ULTRA-FAST, SOFT RECOVERY.
- VERY LOW OVERALL POWER LOSSES IN BOTH THE DIODE AND THE COMPANION TRANSISTOR.
- HIGH FREQUENCY AND/OR HIGH PULSED CURRENT OPERATION.
- HIGH REVERSE VOLTAGE CAPABILITY.
- LOW INDUCTANCE PACKAGE < 5 nH.
- INSULATED PACKAGE :  
Electrical insulation : 2500V<sub>RMS</sub>  
Capacitance : < 45pF.



### DESCRIPTION

TURBOSWITCH 1200V drastically cuts losses in all high voltage operations which require extremely fast, soft and noise-free power diodes. Due to their optimized switching performances they also highly decrease power losses in any associated switching IGBT or MOSFET in all "freewheel mode" operations.

They are particularly suitable in motor control circuitries, or in the primary of SMPS as snubber, clamping or demagnetizing diodes. They are also suitable for secondary of SMPS as high voltage rectifier diodes.

### ABSOLUTE RATINGS (limiting values, per diode)

Symbol	Parameter	Value	Unit	
$V_{RRM}$	Repetitive peak reverse voltage	1200	V	
$V_{RSM}$	Non repetitive peak reverse voltage	1200	V	
$I_{F(RMS)}$	RMS forward current	150	A	
$I_{FRM}$	Repetitive peak forward current	$t_p = 5 \mu s$ $F = 5kHz$ square	700	A
$I_{FSM}$	Surge non repetitive forward current	$t_p = 10ms$ sinusoidal	420	A
$T_{stg}$	Storage temperature range	- 65 to + 150	°C	
$T_j$	Maximum operating junction temperature	150	°C	

## STTA9012TV1/2

### THERMAL AND POWER DATA (per diode)

Symbol	Parameter	Test conditions	Value	Unit
R <sub>th(j-c)</sub>	Junction to case thermal resistance	Per diode	0.85	°C/W
		Total	0.48	
		Coupling	0.1	
P <sub>1</sub>	Conduction power dissipation	I <sub>F(AV)</sub> = 45A δ = 0.5 T <sub>c</sub> = 70°C	94	W
P <sub>max</sub>	Total power dissipation P <sub>max</sub> = P <sub>1</sub> + P <sub>3</sub> (P <sub>3</sub> = 10% P <sub>1</sub> )	T <sub>c</sub> = 62°C	104	W

### STATIC ELECTRICAL CHARACTERISTICS (per diode)

Symbol	Parameter	Test conditions	Min	Typ	Max	Unit
V <sub>F</sub> *	Forward voltage drop	I <sub>F</sub> = 45A T <sub>j</sub> = 25°C T <sub>j</sub> = 125°C		1.3	2.05 1.85	V
I <sub>R</sub> **	Reverse leakage current	V <sub>R</sub> = 0.8 x V <sub>R(RM)</sub> T <sub>j</sub> = 25°C T <sub>j</sub> = 125°C		3	200 12	μA mA
V <sub>to</sub>	Threshold voltage	I <sub>p</sub> < 3.I <sub>AV</sub> T <sub>j</sub> = 125°C			1.57	V
R <sub>d</sub>	Dynamic resistance				6	mΩ

Test pulses : \* tp = 380 μs, δ < 2%  
\*\* tp = 5 ms, δ < 2%

To evaluate the maximum conduction losses use the following equation :  
 $P = V_{to} \times I_{F(AV)} + r_d \times I_{F(RMS)}^2$

### DYNAMIC ELECTRICAL CHARACTERISTICS (per diode)

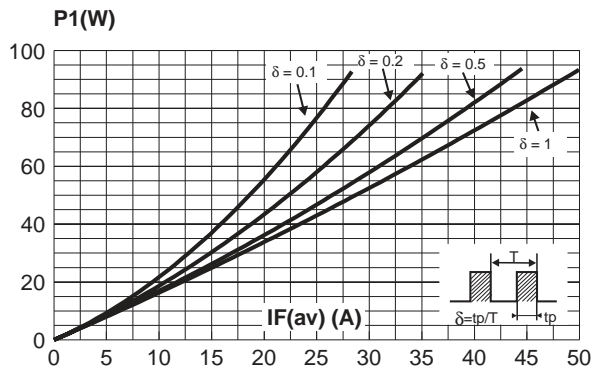
#### TURN-OFF SWITCHING

Symbol	Parameter	Test conditions	Min	Typ	Max	Unit
t <sub>rr</sub>	Reverse recovery time	T <sub>j</sub> = 25°C I <sub>F</sub> = 0.5 A I <sub>R</sub> = 1A I <sub>rr</sub> = 0.25A I <sub>F</sub> = 1 A dI <sub>F</sub> /dt = -50A/μs V <sub>R</sub> = 30V		65	115	ns
I <sub>RM</sub>	Maximum reverse recovery current	T <sub>j</sub> = 125°C V <sub>R</sub> = 600V I <sub>F</sub> = 45A dI <sub>F</sub> /dt = -360 A/μs dI <sub>F</sub> /dt = -500 A/μs		50	60	A
S factor	Softness factor	T <sub>j</sub> = 125°C V <sub>R</sub> = 600V I <sub>F</sub> = 45A dI <sub>F</sub> /dt = -500 A/μs		1.2		-

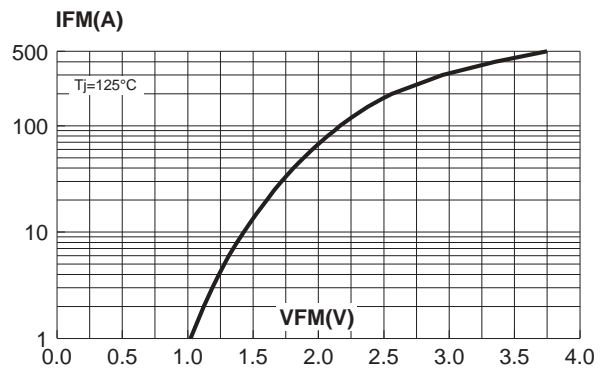
#### TURN-ON SWITCHING

Symbol	Parameter	Test conditions	Min	Typ	Max	Unit
t <sub>fr</sub>	Forward recovery time	T <sub>j</sub> = 25°C I <sub>F</sub> = 45 A, dI <sub>F</sub> /dt = 360 A/μs measured at 1.1 × V <sub>Fmax</sub>			900	ns
V <sub>Fp</sub>	Peak forward voltage	T <sub>j</sub> = 25°C I <sub>F</sub> = 45A, dI <sub>F</sub> /dt = 360 A/μs I <sub>F</sub> = 45A, dI <sub>F</sub> /dt = 500 A/μs		30	30	V

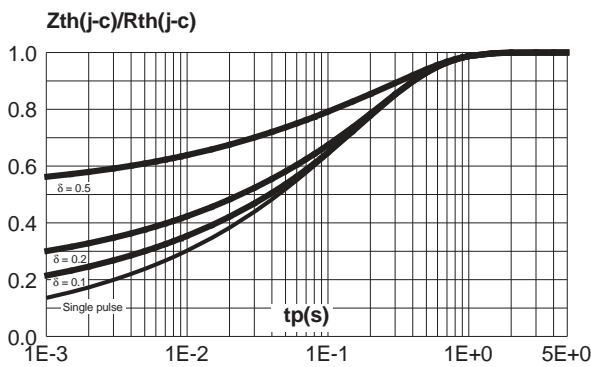
**Fig. 1:** Conduction losses versus average current (per diode).



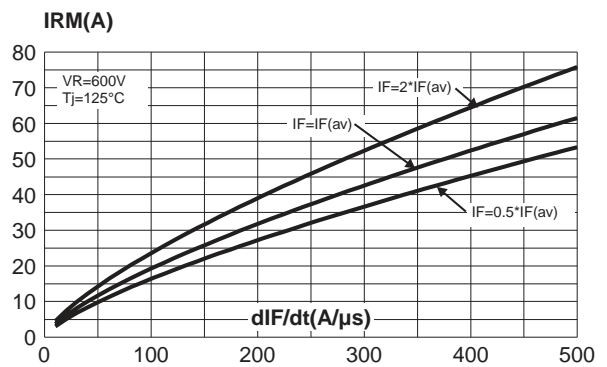
**Fig. 2:** Forward voltage drop versus forward current (maximum values, per diode).



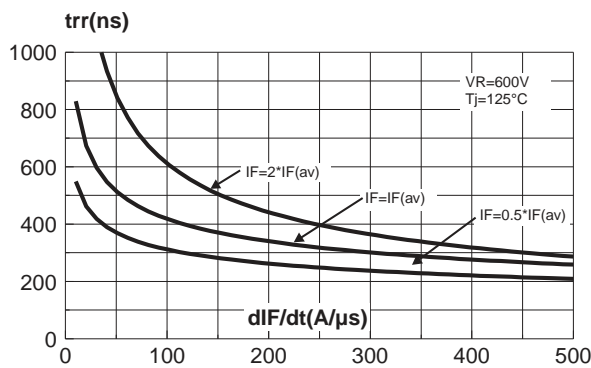
**Fig. 3:** Relative variation of thermal impedance junction to case versus pulse duration (per diode).



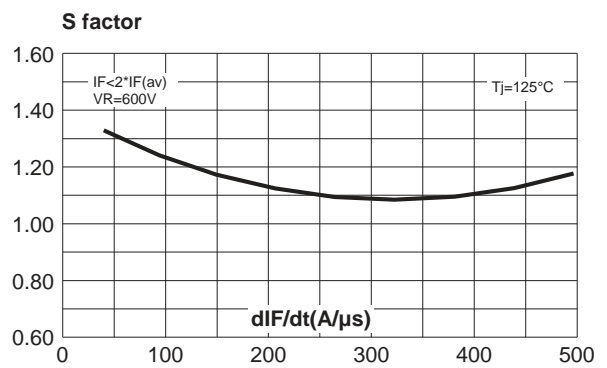
**Fig. 4:** Peak reverse recovery current versus  $dIF/dt$  (90% confidence, per diode).



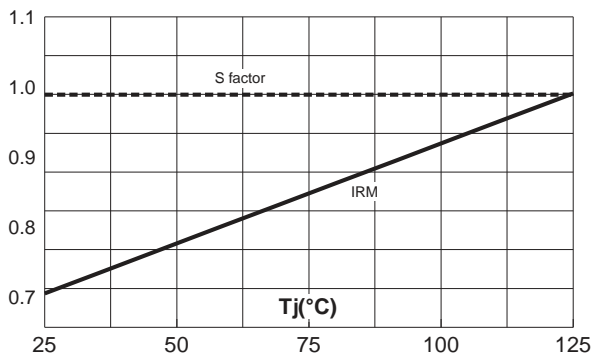
**Fig. 5:** Reverse recovery time versus  $dIF/dt$  (90% confidence, per diode).



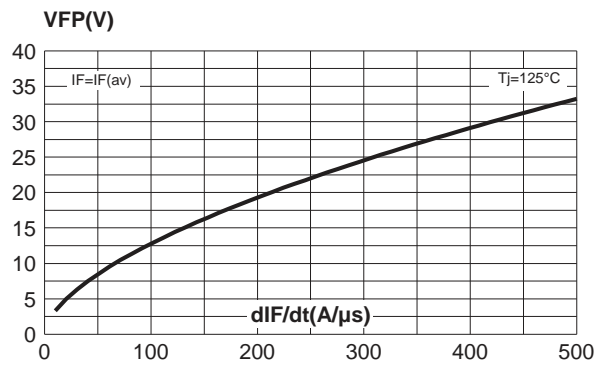
**Fig. 6:** Softness factor ( $tb/ta$ ) versus  $dIF/dt$  (typical values).



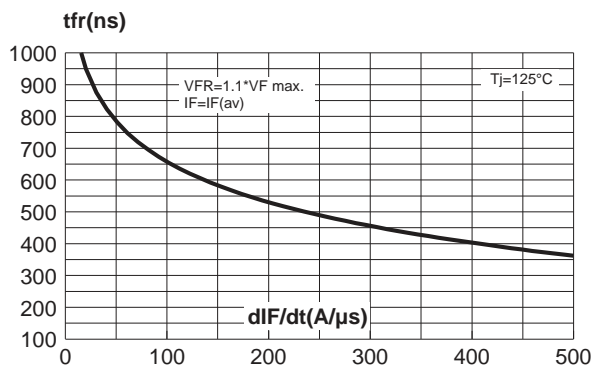
**Fig. 7:** Relative variation of dynamic parameters versus junction temperature (reference:  $T_j=125^\circ\text{C}$ ).



**Fig. 8:** Transient peak forward voltage versus  $dI_F/dt$  (90% confidence, per diode).

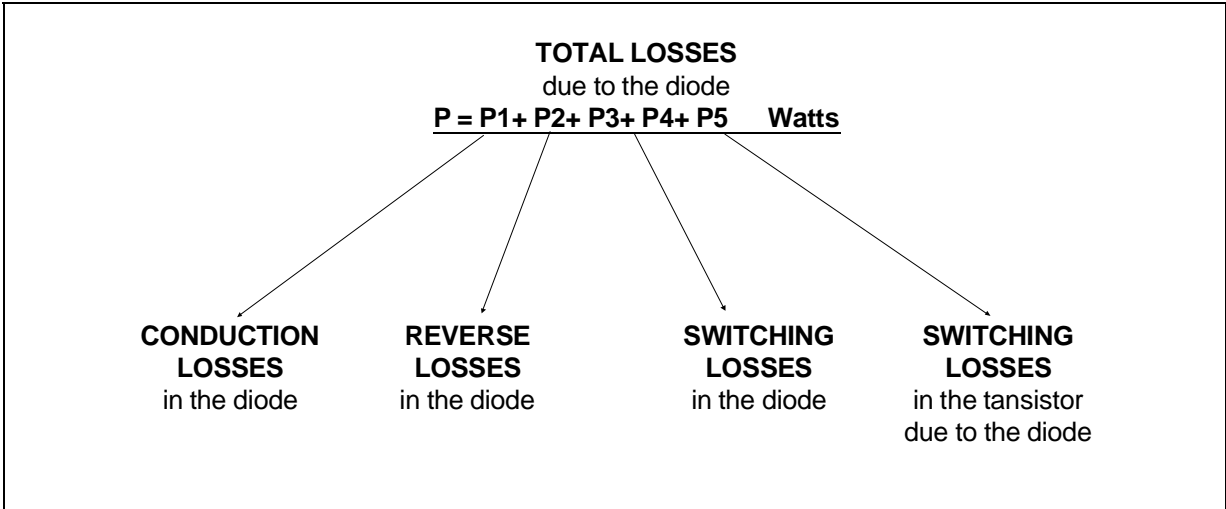


**Fig. 9:** Forward recovery time versus  $dI_F/dt$  (90% confidence, per diode).



**APPLICATION DATA**

The 1200V TURBOSWITCH series has been designed to provide the lowest overall power losses in all high frequency or high pulsed current operations. In such applications (Fig A to D), the way of calculating the power losses is given below :



**Fig. A :** "FREEWHEEL" MODE.

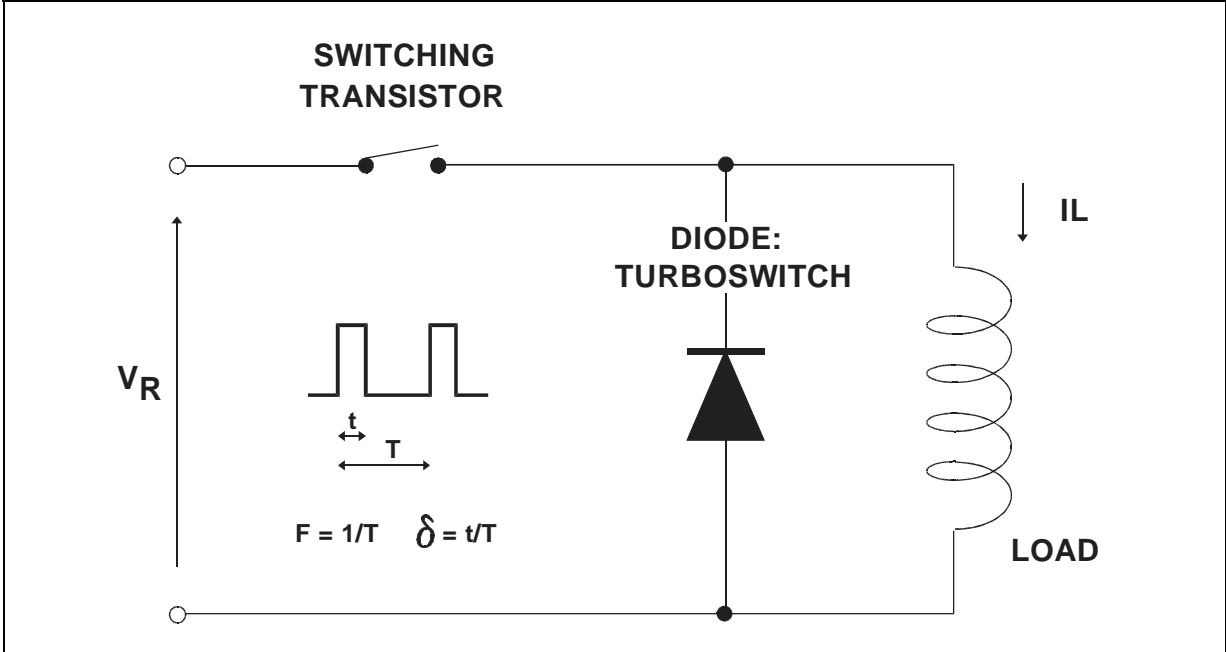


Fig. B : SNUBBER DIODE.

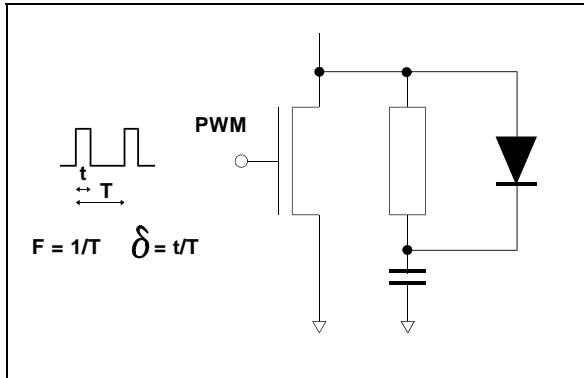


Fig. C : DEMAGNETIZING DIODE.

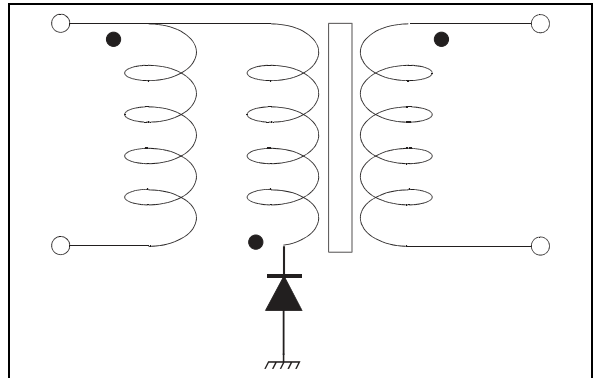
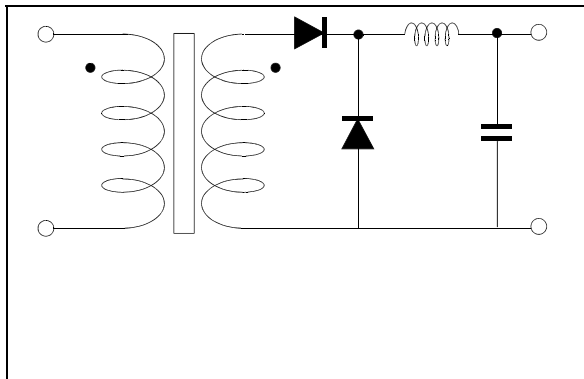
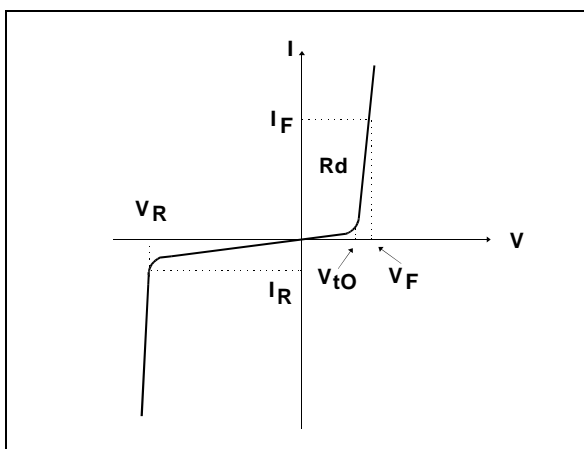


Fig. D : RECTIFIER DIODE.



**STATIC & DYNAMIC CHARACTERISTICS . POWER LOSSES .**

Fig. E: STATIC CHARACTERISTICS



**Conduction losses :**

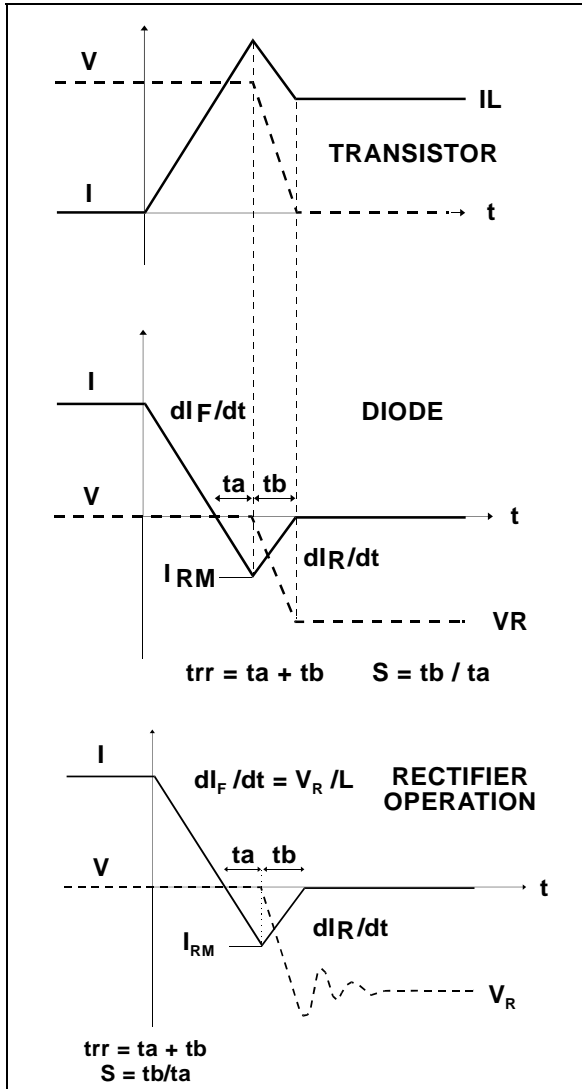
$$P1 = V_{t0} \cdot I_F(AV) + R_d \cdot I_F^2(RMS)$$

**Reverse losses :**

$$P2 = V_R \cdot I_R \cdot (1 - \delta)$$

APPLICATION DATA (Cont'd)

Fig. F: TURN-OFF CHARACTERISTICS



**Turn-on losses :**  
(in the transistor, due to the diode)

$$P5 = \frac{V_R \times I_{RM}^2 \times (3 + 2 \times S) \times F}{6 \times dI/dt} + \frac{V_R \times I_{RM} \times I_L \times (S + 2) \times F}{2 \times dI/dt}$$

**Turn-off losses (in the diode) :**

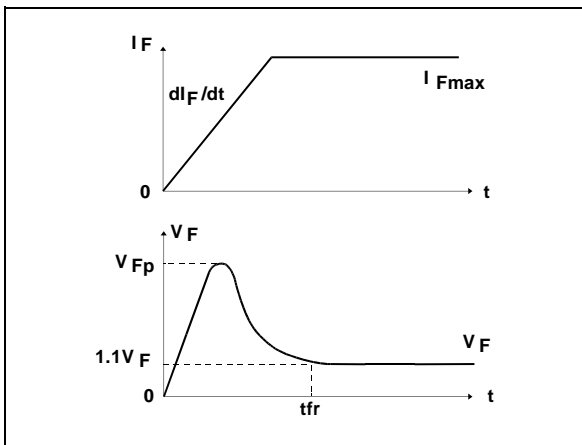
$$P3 = \frac{V_R \times I_{RM}^2 \times S \times F}{6 \times dI/dt}$$

**Turn-off losses :**  
(with non negligible serial inductance)

$$P3' = \frac{V_R \times I_{RM}^2 \times S \times F}{6 \times dI/dt} + \frac{L \times I_{RM}^2 \times F}{2}$$

P3,P3' and P5 are suitable for power MOSFET and IGBT

Fig. G: TURN-ON CHARACTERISTICS

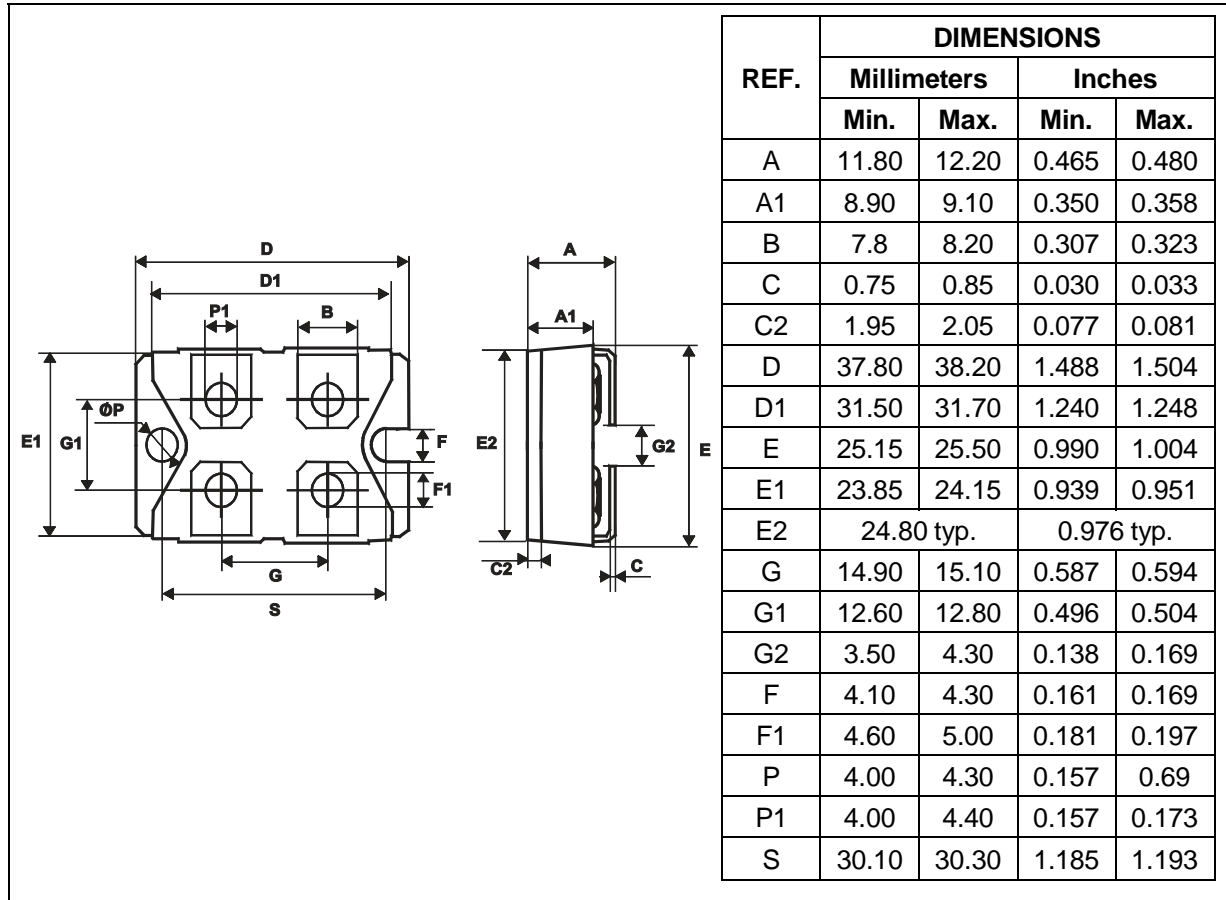


**Turn-on losses :**

$$P4 = 0.4 (V_{FP} - V_F) \cdot I_{Fmax} \cdot t_{tr} \cdot F$$

# STTA9012TV1/2

## PACKAGE MECHANICAL DATA ISOTOP



- Cooling method: by conduction (C)
- Recommended torque value: 1.3 N.m (MAX 1.5 N.m) for the 6 x M4 screws. (2 x M4 screws recommended for mounting the package on the heatsink and the 4 screws for terminals).
- The screws supplied with the package are suitable for mounting on a board (or other types of terminals) with a thickness of 0.6 mm min and 2.2 mm max.

Ordering type	Marking	Package	Weight	Base qty	Delivery mode
STTA9012TV1	STTA9012TV1	ISOTOP	27g.	10	Tube
STTA9012TV2	STTA9012TV2	ISOTOP	without screws	10	Tube

- Epoxy meets UL94,V0

Information furnished is believed to be accurate and reliable. However, STMicroelectronics assumes no responsibility for the consequences of use of such information nor for any infringement of patents or other rights of third parties which may result from its use. No license is granted by implication or otherwise under any patent or patent rights of STMicroelectronics. Specifications mentioned in this publication are subject to change without notice. This publication supersedes and replaces all information previously supplied. STMicroelectronics products are not authorized for use as critical components in life support devices or systems without express written approval of STMicroelectronics.

The ST logo is a registered trademark of STMicroelectronics

© 1999 STMicroelectronics - Printed in Italy - All rights reserved.

STMicroelectronics GROUP OF COMPANIES

Australia - Brazil - China - Finland - France - Germany - Hong Kong - India - Italy - Japan - Malaysia  
Malta - Morocco - Singapore - Spain - Sweden - Switzerland - United Kingdom - U.S.A.

<http://www.st.com>