

TABLE 1

番号 No.	部品 PART	材質 MATERIAL	
①	ハウジング HOUSING	ナイロン, UL94-V0, 色 : 自然色(ベージュ) / 黒 NYLON (PA), UL94-V0, COLOR : NATURAL(BEIGE) / BLACK	
②	ターミナル TERMINAL	材料 MATERIAL	黄銅 BRASS
		下地めっき UNDER PLATING	ニッケルめっき 1.27マイクロメートル以上 NICKEL PLATING 1.27micro-meter MIN
		接点部、テール CONTACT AND TAIL	無光沢錫めっき 2.54マイクロメートル以上 MATTE TIN PLATING 2.54 micro-meter MIN

注記
NOTE

- △. 材質および仕上げ(めっき仕様) : TABLE 1 参照
MATERIAL AND FINISH: SEE TABLE 1
- . 製品仕様書 : PS-87437-001
PRODUCT SPECIFICATION : PS-87437-001
- . 製品取扱説明書 : 874370000-AS
APPLICATION SPECIFICATION : 874370000-AS
- . テール平坦度 : 0.1以下
TAIL COPLANARITY TO BE 0.1 MAX.
- △. 嵌合相手 : 87439シリーズ (リセプタクルハウジング), 87421シリーズ (圧着端子)
MATE WITH 87439 SERIES (RECEPTACLE HOUSING) AND 87421 SERIES (CRIMP TERMINAL).
- . 本製品は錫めっき品である。金めっき品は202706シリーズを参照。
THIS PRODUCT IS TIN PLATING.
FOR GOLD PLATING, REFER TO 202706 SERIES.

21.2	22.8	21.0	23.8	87438-15*1	15
19.7	21.3	19.5	22.3	87438-14*1	14
18.2	19.8	18.0	20.8	87438-13*1	13
16.7	18.3	16.5	19.3	87438-12*1	12
15.2	16.8	15.0	17.8	87438-11*1	11
13.7	15.3	13.5	16.3	87438-10*1	10
12.2	13.8	12.0	14.8	87438-09*1	9
10.7	12.3	10.5	13.3	87438-08*1	8
9.2	10.8	9.0	11.8	87438-07*1	7
7.7	9.3	7.5	10.3	87438-06*1	6
6.2	7.8	6.0	8.8	87438-05*1	5
4.7	6.3	4.5	7.3	87438-04*1	4
3.2	4.8	3.0	5.8	87438-03*1	3
1.7	3.3	1.5	4.3	87438-02*1	2
D	C	B	A	ヘッダー番号 HEADER NO.	極数 CIRCUIT SIZE

THIS DRAWING CONTAINS INFORMATION THAT IS PROPRIETARY TO MOLEX ELECTRONIC TECHNOLOGIES, LLC AND SHOULD NOT BE USED WITHOUT WRITTEN PERMISSION

DIMENSION UNITS mm	SCALE 8:1	CURRENT REV DESC: REVISED		molex		
GENERAL TOLERANCES (UNLESS SPECIFIED)		EC NO: 605982				
ANGULAR TOL ± 3.0°	4 PLACES ± 0.2	DRWN: RTANAKA02	2018/12/06	PRODUCT CUSTOMER DRAWING		
3 PLACES ± 0.2	2 PLACES ± 0.2	CHK'D: AIDA	2019/04/26	DOCUMENT NUMBER		
1 PLACE ± 0.2	0 PLACES ± 0.2	APPR: SAKIYAMA	2019/04/26	SD-87438-001		
DRAFT WHERE APPLICABLE MUST REMAIN WITHIN DIMENSIONS		INITIAL REVISION:		DOC TYPE	DOC PART	REVISION
THIRD ANGLE PROJECTION		DRWN: RHORI	2013/10/21	PSD	001	F
DRAWING		APPR: NUKITA	2013/10/22	SHEET NUMBER		
A3-SIZE		SERIES	87438	1 OF 3		
MATERIAL NUMBER		CUSTOMER		GENERAL MARKET		
SEE SHEET 3						

推奨基板レイアウト
RECOMMENDED PCB LAYOUT

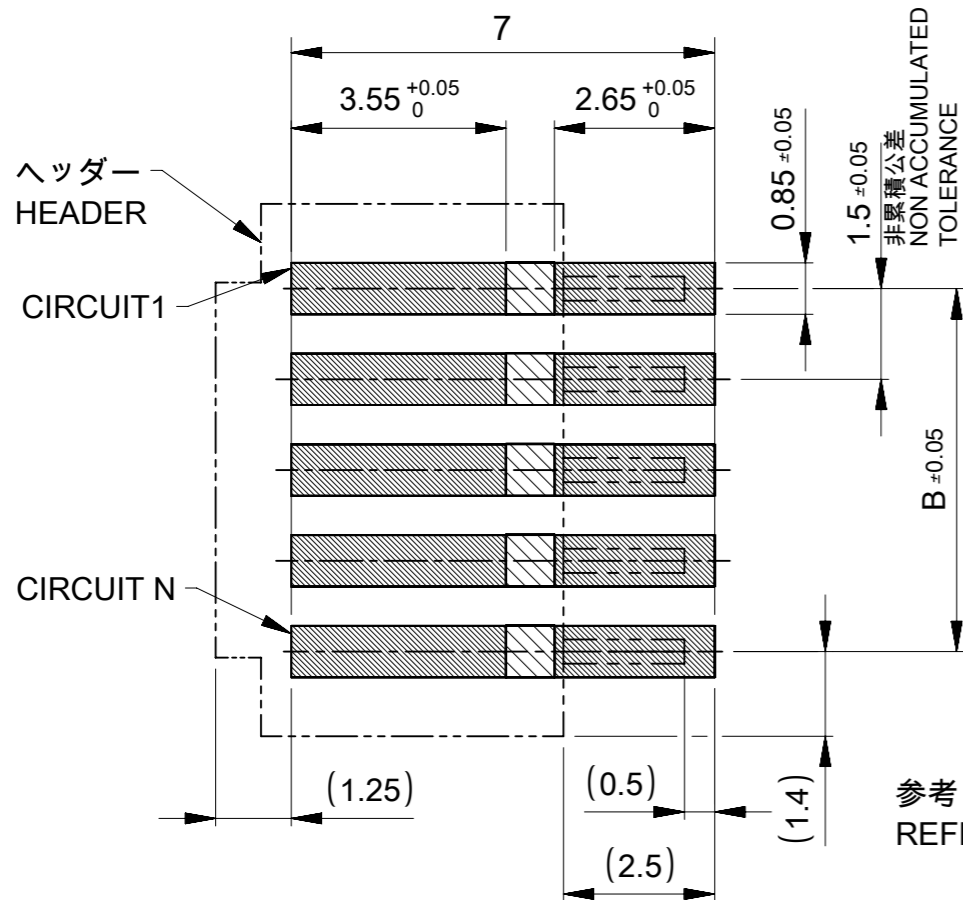

参考 : 基板厚 1.0mm
REFERENCE : PCB THICKNESS 1.0mm
メタルマスク厚 0.12mm
STENCIL THICKNESS 0.12mm
マスク開口率100%
APERTURE RATIO 100%.

 : 半田エリア (パターンエリア)
SOLDER AREA (COPPER ZONE)

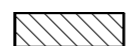
 : 半田禁止エリア (パターン禁止エリア)
SOLDER KEEP OUT AREA (NO-COPPER ZONE)
半田上がりを防ぐため。
TO PREVENT SOLDER LIFTING.
レジストによって分離する場合は、パターン面よりも盛り上がらないこと。
IF APPLY RESIST IN THIS AREA, LEVEL AS PATTERN AREA FACE.

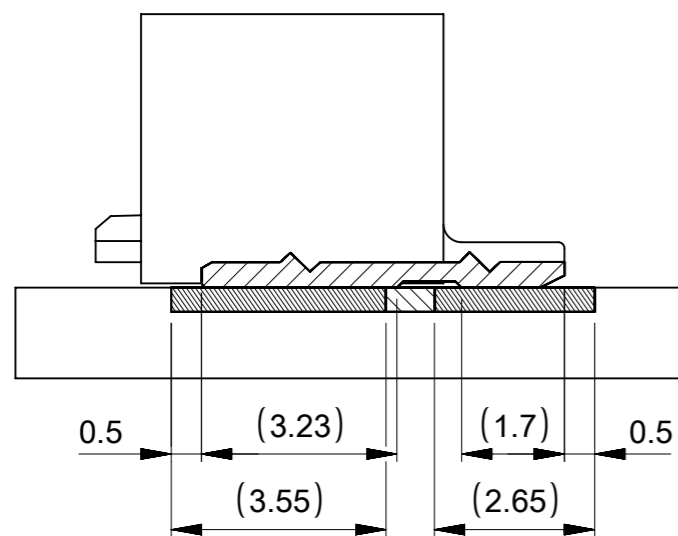

SECTION Z-Z

5 嵌合図
MATED CONNECTORS

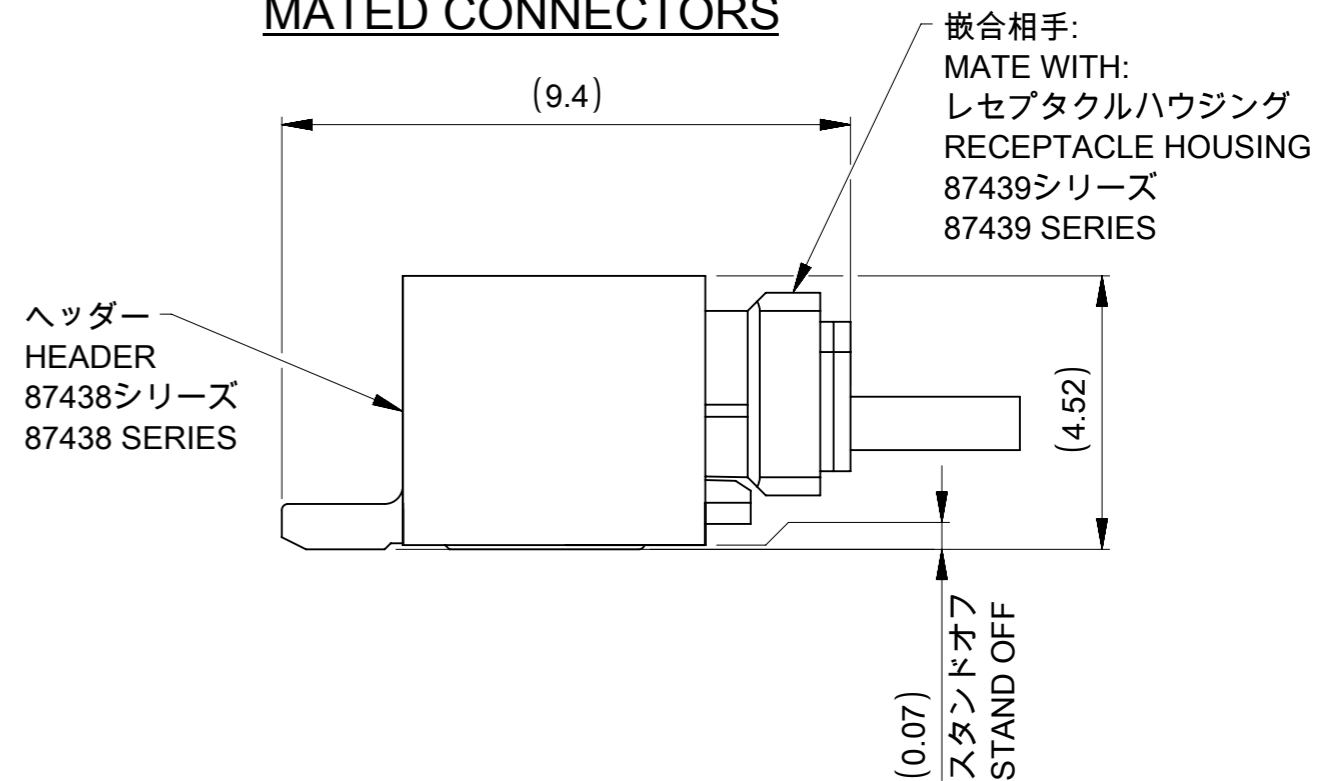

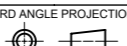
THIS DRAWING CONTAINS INFORMATION THAT IS PROPRIETARY TO MOLEX ELECTRONIC TECHNOLOGIES, LLC AND SHOULD NOT BE USED WITHOUT WRITTEN PERMISSION									
DIMENSION UNITS		SCALE		CURRENT REV DESC: REVISED				molex	
mm		8:1							
GENERAL TOLERANCES (UNLESS SPECIFIED)				EC NO: 605982				PICO-SPOX 1.5 WB CONN R/A HEADER ASSY (SMT TIN PLATING VERSION)	
ANGULAR TOL		± 3.0°		DRWN: RTANAKA02		2018/12/06			
4 PLACES		± 0.2		CHK'D: AIDA		2019/04/26			
3 PLACES		± 0.2		APPR: SAKIYAMA		2019/04/26			
2 PLACES		± 0.2		INITIAL REVISION:				PRODUCT CUSTOMER DRAWING	
1 PLACE		± 0.2		DRWN: RHORI		2013/10/21		DOCUMENT NUMBER	
0 PLACES		± 0.2		APPR: NUKITA		2013/10/22		SD-87438-001	
DRAFT WHERE APPLICABLE MUST REMAIN WITHIN DIMENSIONS				THIRD ANGLE PROJECTION		DRAWING		SHEET NUMBER	
						A3-SIZE		2 OF 3	
				SERIES		MATERIAL NUMBER		CUSTOMER	
				87438		SEE SHEET 3		GENERAL MARKET	
DOCUMENT STATUS				P1		RELEASE DATE		2019/04/26 09:56:08	

チューブ梱包 詳細
TUBE PACKING DETAIL

発注番号
ORDER NUMBER

87438- * * * 2

極数 CIRCUIT SIZE	ハウジングカラー HOUSING COLOR
02 から 15 02 TO 15	4: ベージュ BEIGE
	6: 黒 BLACK

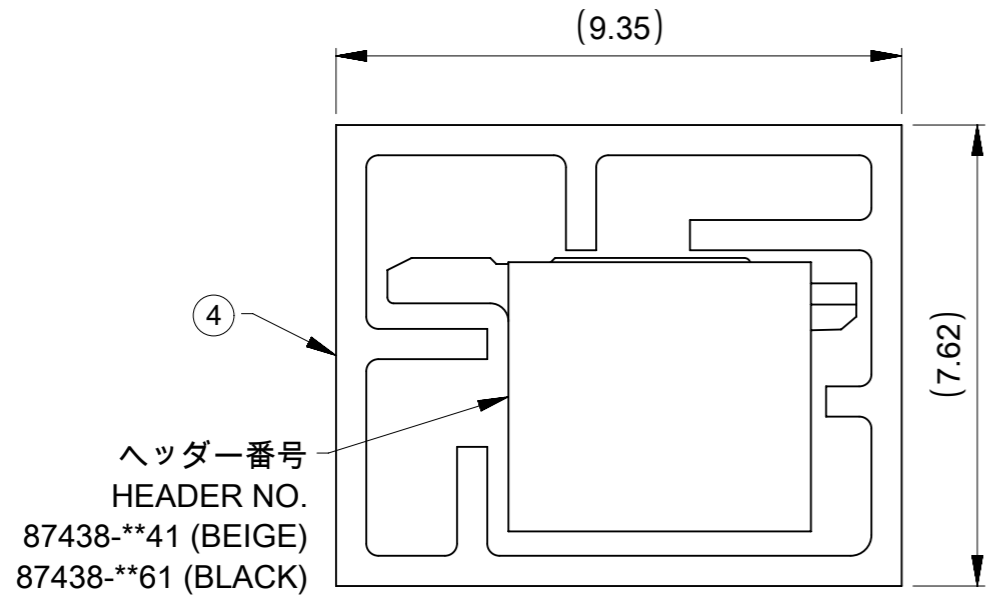

注記
NOTE

- 7. 本製品は乾燥剤入りハイバリア梱包での納品となる。
THIS PRODUCTS IS DELIVERED IN A HIGH BARRIER PACKAGE WITH DESICCANT.
- 8. 梱包仕様書 : SPK-87438-002
PACKING INFORMATION : SPK-87438-002

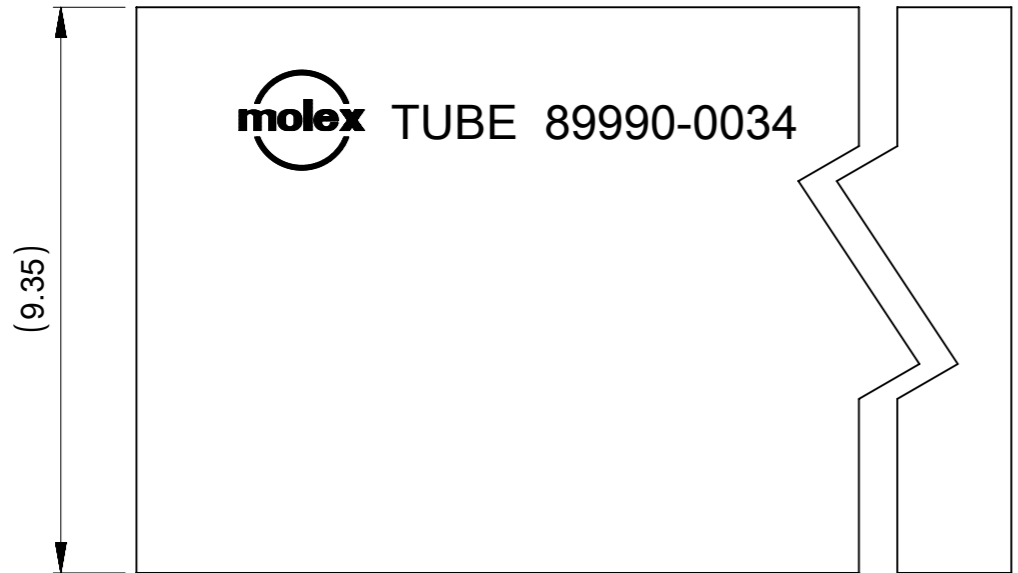

番号 NO.	部品 PART	材質 MATERIAL
④	チューブ TUBE	ポリ塩化ビニル POLYVINYL CHLORIDE (PVC)

DOCUMENT STATUS	P1	RELEASE DATE	2019/04/26	09:56:08
-----------------	----	--------------	------------	----------

THIS DRAWING CONTAINS INFORMATION THAT IS PROPRIETARY TO MOLEX ELECTRONIC TECHNOLOGIES, LLC AND SHOULD NOT BE USED WITHOUT WRITTEN PERMISSION		CURRENT REV DESC: REVISED		molex			
DIMENSION UNITS mm	SCALE 8:1						
GENERAL TOLERANCES (UNLESS SPECIFIED)		EC NO: 605982		PICO-SPOX 1.5 WB CONN R/A HEADER ASSY (SMT TIN PLATING VERSION)			
ANGULAR TOL	± 3.0 °	DRWN: RTANAKA02	2018/12/06	PRODUCT CUSTOMER DRAWING			
4 PLACES	± 0.2	CHK'D: AIDA	2019/04/26	DOCUMENT NUMBER			
3 PLACES	± 0.2	APPR: SAKIYAMA	2019/04/26	SD-87438-001	DOC TYPE		
2 PLACES	± 0.2	INITIAL REVISION:		001	DOC PART		
1 PLACE	± 0.2	DRWN: RHORI	2013/10/21	F	REVISION		
0 PLACES	± 0.2	APPR: NUKITA	2013/10/22	SHEET NUMBER			
DRAFT WHERE APPLICABLE MUST REMAIN WITHIN DIMENSIONS		THIRD ANGLE PROJECTION	DRAWING	SERIES	MATERIAL NUMBER	CUSTOMER	SHEET NUMBER
			A3-SIZE	87438	SEE SHEET 3	GENERAL MARKET	3 OF 3