

NOTES:

1. MATERIALS: HOUSING--LIQUID CRYSTAL POLYMER (LCP), GLASS FILLED, UL94V-0, COLOR: BLACK, TERMINAL: PHOSPHOR BRONZE.
2. FINISH: 0.75 MICROMETERS MINIMUM SELECTIVE GOLD (Au) IN MATING AREA; 2.50 MICROMETERS MINIMUM SELECTIVE TIN (Sn) IN TAIL AREA; NICKEL (Ni) UNDERPLATE OVERALL.
3. THIS PART CONFORMS TO MOLEX PRODUCT SPECIFICATION PS-73670-9999.
4. FOR MIXED CONTACT MATING LENGTHS, CONSULT FACTORY FOR AVAILABILITY.
5. PACKAGE PER PK-70873-0818.
6. PARTS MARKED WITH PART NUMBER AND DATE CODE, ON EITHER SIDE, APPROXIMATELY WHERE SHOWN.

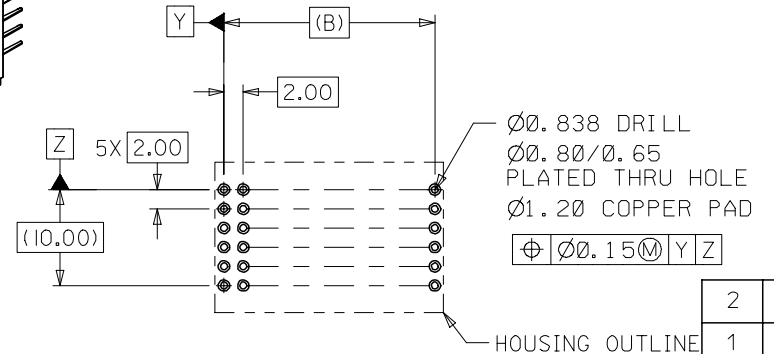
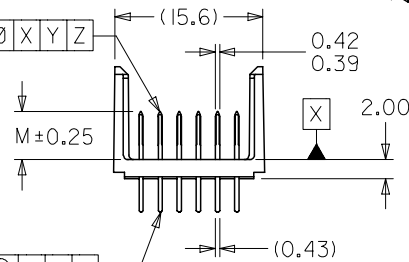
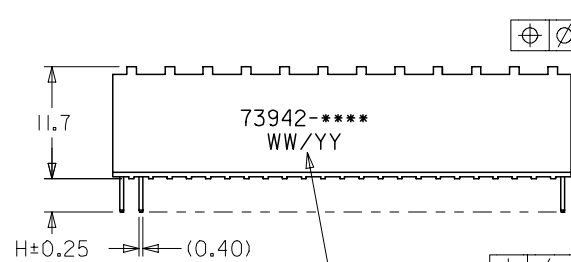
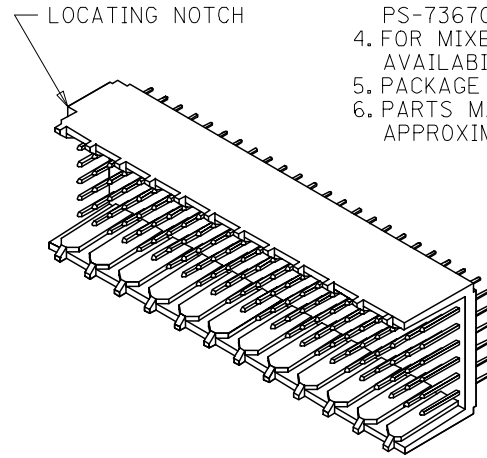
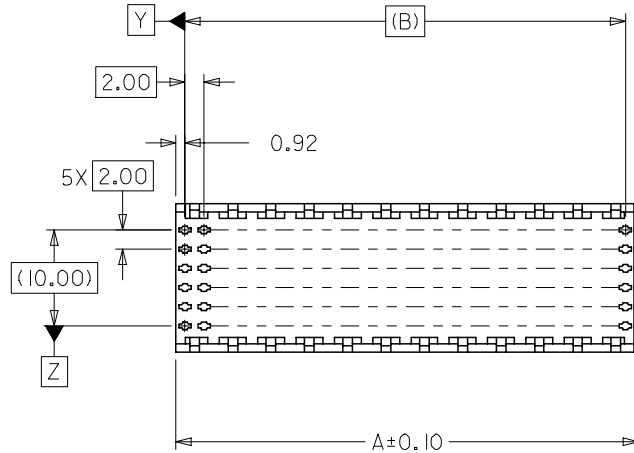

PCB LAYOUT: COMPONENT SIDE
RECOMMENDED PCB THICKNESS: 2.50 MIN.

| | |
|-----|-----|
| 2 | A |
| 1 | G |
| SHT | REV |

SEE NOTE 6

| | |
|-------------------------|-----------------|
| MODIFY FINISH NOTE | QUALITY SYMBOLS |
| EC NO: UCP2007-2259 | ▽=0 |
| IDRWMSIBARRA 2007/03/13 | ▽=0 |
| CHKD:BBARKER 2007/03/21 | |
| APPR:SMILLER 2007/03/22 | |
| DESCRIPTION | |
| REV | |

GENERAL TOLERANCES (UNLESS SPECIFIED)

| | mm | INCH |
|----------|--------|-------|
| 4 PLACES | ± --- | ± --- |
| 3 PLACES | ± --- | ± --- |
| 2 PLACES | ± 0.05 | ± --- |
| 1 PLACE | ± 0.10 | ± --- |
| ANGULAR | ±1/2° | |

DIMENSION STYLE
MM ONLY

| | |
|--------------|------------|
| DRAWN BY | DATE |
| JB INGHAM | 1998/01/13 |
| CHECKED BY | DATE |
| SREED | 1998/01/13 |
| APPROVED BY | DATE |
| CBIXLER | 1998/01/13 |
| MATERIAL NO. | |
| SEE CHART | |

SCALE
2:1

TITLE
SALES ASSY HDM BACKPLANE
OPEN END OPTION
SOLDER TAIL VERSION

DESIGN UNITS
METRIC

THIRD ANGLE PROJECTION

MOLEX INCORPORATED

DOCUMENT NO.
SD-73942-001

DRAFT WHERE APPLICABLE
MUST REMAIN
WITHIN DIMENSIONS

THIS DRAWING CONTAINS INFORMATION THAT IS PROPRIETARY TO MOLEX INCORPORATED AND SHOULD NOT BE USED WITHOUT WRITTEN PERMISSION



SHEET NO.
1 OF 2

MATERIAL NUMBER ASSIGNMENT

73942-* * 0 0

| NUMBER | CIRCUIT SIZE | DIM "A" | DIM "B" | DIM "H" |
|--------|--------------|---------|---------|---------|
| 0 | 72 | 23.84 | 22.00 | 2.0 |
| 1 | 144 | 47.84 | 46.00 | 2.0 |
| 2 | 72 | 23.84 | 22.00 | 2.5 |
| 3 | 144 | 47.84 | 46.00 | 2.5 |
| 4 | 72 | 23.84 | 22.00 | 3.0 |
| 5 | 144 | 47.84 | 46.00 | 3.0 |
| 6 | 72 | 23.84 | 22.00 | 3.5 |
| 7 | 144 | 47.84 | 46.00 | 3.5 |

| NUMBER | DIM "M" |
|--------|---------|
| 0 | 5.0 |
| 1 | 5.5 |
| 2 | 6.0 |

| | | | | | | | | | |
|--|---|---|---|-----------------|--|--|--|-----------|--|
| SEE SHEET 1 EC No. U8 1577 DRWN:JBINGHAM 98/0203 CHK: SREED 98/0203 APPR:CBIXLER 98/0203 | MAJOR  CRITICAL  | QUALITY SYMBOLS | GENERAL TOLERANCES: (UNLESS SPECIFIED) | SCALE ---:-- | DESIGN UNITS <input checked="" type="checkbox"/> mm <input type="checkbox"/> INCH | DIMENSIONS: <input type="checkbox"/> mm <input type="checkbox"/> INCH <input checked="" type="checkbox"/> mm ONLY | SHT REV | | |
| | | DRAWN BY & DATE JBINGHAM 98/01/13 | THIRD ANGLE PROJECTION  | | CHECKED BY & DATE SREED 98/01/13 | | TITLE: SALES ASSY, HDM BACKPLANE OPEN END OPTION SOLDER TAIL VERSION | | |
| | | APPROVED BY & DATE CBIXLER 98/01/13 | ANGLAR: ± ° | | CAD FILENAME S73942X2.DGN | | MOLEX INCORPORATED | | |
| | | DRAFT WHERE APPLICABLE MUST REMAIN WITHIN DIMENSIONS | THIS DRAWING CONTAINS INFORMATION THAT IS PROPRIETARY TO MOLEX INCORPORATED AND SHOULD NOT BE USED WITHOUT WRITTEN PERMISSION. | | MATERIAL NO. SEE CHART | DRAWING NO. SD-73942-001 | SHEET NO. 2 | SIZE B | |