

# HR3P-N4xC-00000

## 3-mm Round Infrared LED Lamp

### Description

The Broadcom® HR3P-N4xC-00000 is a 3-mm round infrared LED lamp. This product is available in a industrial-standard 3-mm radial through-hole lamp package which makes this product versatile and easy to use. It comes with a 950-nm peak wavelength and two types of viewing angles, 30 degrees and 45 degrees.

This product is suitable for a wide variety of applications in consumer and industrial segments, such as smart meters, machine controls, and light curtains. This product is a cost-effective solution which offers superior performance and a uniform illumination pattern.

### Features

- Untinted, non-diffused
- Low power consumption
- Industrial-standard 2.54-mm lead pitch

### Applications

- Home appliances
- Office automation
- Light curtains

**Figure 1: Package Drawing**

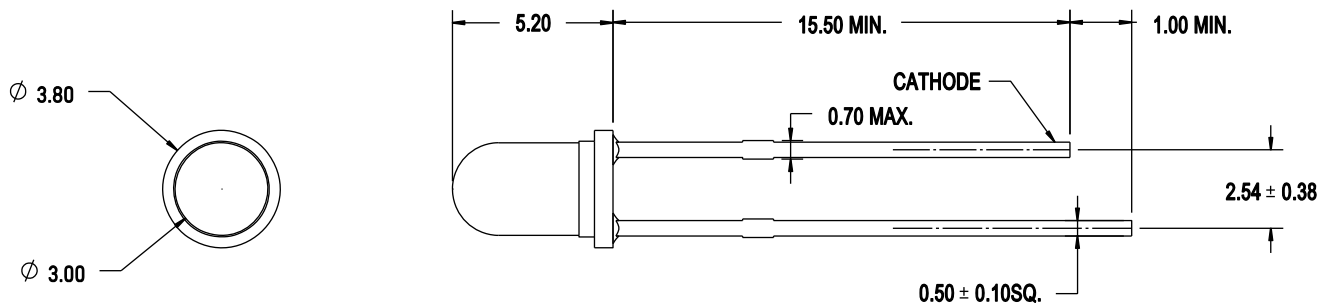

### NOTE:

1. All dimensions are in millimeters (mm).
2. Tolerance is  $\pm 0.25$  mm unless otherwise specified.
3. Lead spacing is measured at the location where the leads emerge from the body.
4. Epoxy meniscus may extend up to maximum of 1.00 mm down the leads.

## Device Selection Guide ( $T_J = 25^\circ\text{C}$ , $I_F = 50\text{ mA}$ )

Part Number	Die Type	Radiant Intensity, $I_e$ (mW/sr) <sup>a, b, c</sup>			Viewing Angle $2\theta_{1/2}$ (Degrees) <sup>d</sup>
		Min.	Typ.	Max.	Typ.
HR3P-N4CC-00000	AlGaAs	28.5	40.0	71.5	30
HR3P-N4EC-00000	AlGaAs	18.0	30.0	45.0	45

- The radiant intensity is measured at the mechanical axis of the package with a single-current pulse condition ( $t_p = 20\text{ ms}$ ).
- The optical axis is closely aligned with the mechanical axis of the package.
- Tolerance is  $\pm 15\%$ .
- $\theta_{1/2}$  is the off axis angle where the radiant intensity is half of the peak intensity.

## Absolute Maximum Ratings

Parameter	Rating	Unit
DC Forward Current <sup>a, b, c</sup>	70	mA
Peak Forward Current <sup>d, e</sup>	500	mA
Power Dissipation	126	mW
LED Junction Temperature	100	$^\circ\text{C}$
Operating Temperature Range	-40 to +85	$^\circ\text{C}$
Storage Temperature Range	-40 to +100	$^\circ\text{C}$

- Derate linearly as shown in [Figure 4](#).
- DC forward current is 30mA at  $T_A = -40^\circ\text{C}$ .
- DC forward current is 50mA at  $T_A = -25^\circ\text{C}$ .
- Duty factor = 1%,  $t_p = 100\ \mu\text{s}$ .
- Pin temperature,  $T_p = 25^\circ\text{C}$ .

## Optical and Electrical Characteristics ( $T_J = 25^\circ\text{C}$ , $I_F = 50\text{ mA}$ )

Parameter	Symbol	Min.	Typ.	Max.	Units	Test Conditions
Radiant Flux <sup>a</sup>	$\phi_e$	—	28	—	mW	$I_F = 50\text{ mA}$ , $t_p = 20\text{ ms}$
Peak Wavelength	$\lambda_{\text{PEAK}}$	—	950	—	nm	$I_F = 50\text{ mA}$ , $t_p = 20\text{ ms}$
Temperature Coefficient of Brightness	$\text{TC}_{I_e}$	—	-0.31	—	%/ $^\circ\text{C}$	$I_F = 50\text{ mA}$
Spectral Line Half-Width	$\Delta\lambda_{1/2}$	—	40	—	nm	$I_F = 50\text{ mA}$ , $t_p = 20\text{ ms}$
Forward Voltage <sup>b</sup>	$V_F$	1.20	1.40	1.80	V	$I_F = 50\text{ mA}$
Temperature Coefficient of $V_F$	$\text{TC}_{V_F}$	—	-1.0	—	mV/ $^\circ\text{C}$	$I_F = 50\text{ mA}$
Reverse Voltage <sup>c</sup>	$V_R$	5	—	—	V	$I_R = 10\ \mu\text{A}$
Rise Time	$t_r$	—	15	—	ns	$I_F = 50\text{ mA}$
Fall Time	$t_f$	—	30	—	ns	$I_F = 50\text{ mA}$
Thermal Resistance	$R\theta_{J-S}$	—	200	—	$^\circ\text{C}/\text{W}$	LED junction to pin

- The radiant flux,  $\phi_e$ , is the total flux output as measured with an integrating sphere at a single current pulse condition ( $t_p = 20\text{ ms}$ ).
- Forward voltage tolerance is  $\pm 0.1\text{V}$ .
- Indicates product final test condition. Long term reverse bias is not recommended.

Figure 2: Relative Radiant Intensity vs. Mono Pulse Current

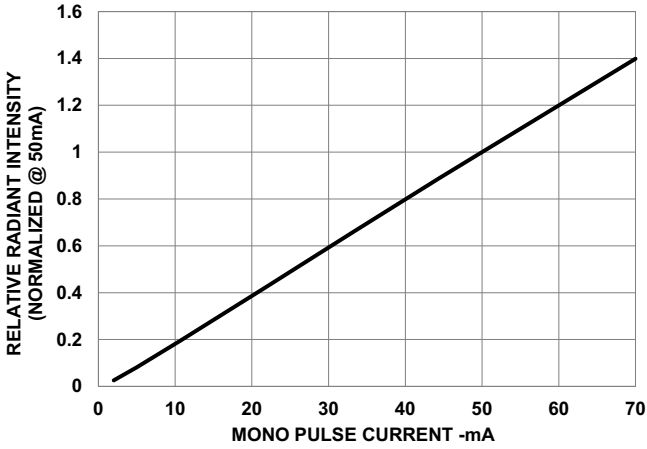

Figure 3: Forward Current vs. Forward Voltage

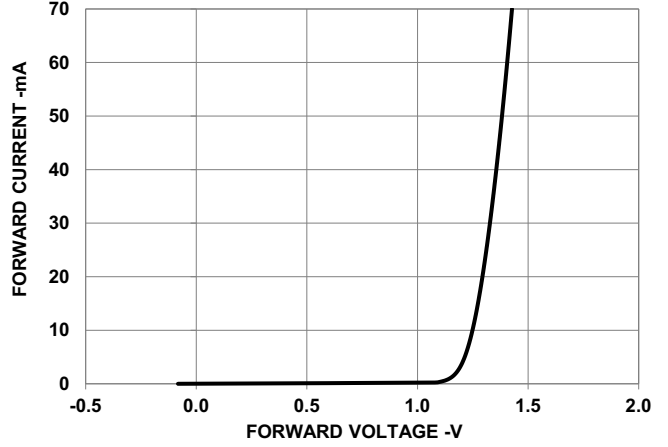

Figure 4: Maximum Forward Current vs. Ambient Temperature

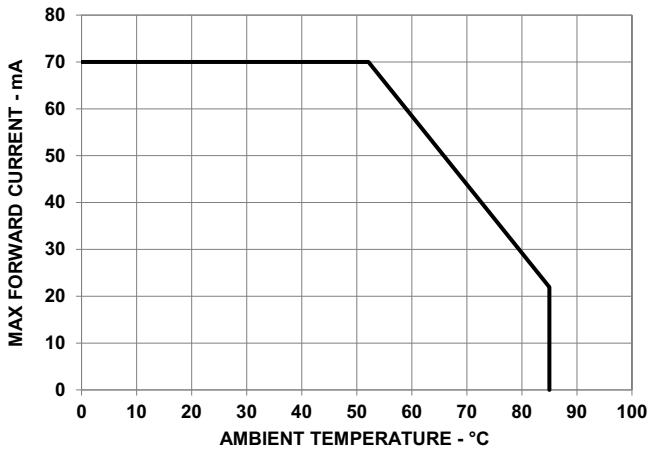

Figure 5: Radiation Pattern

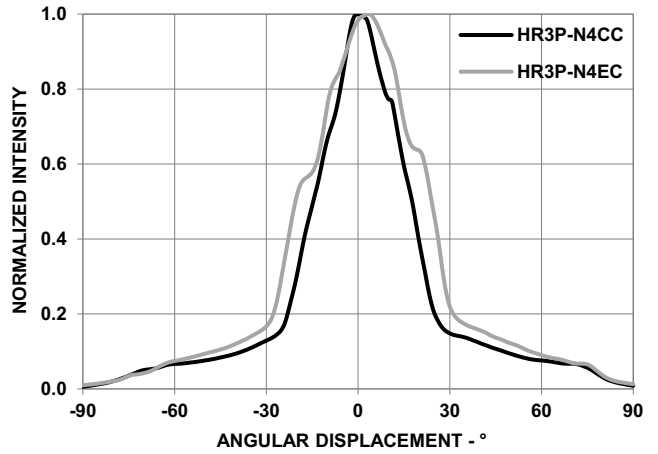

Figure 6: Spectral Distribution

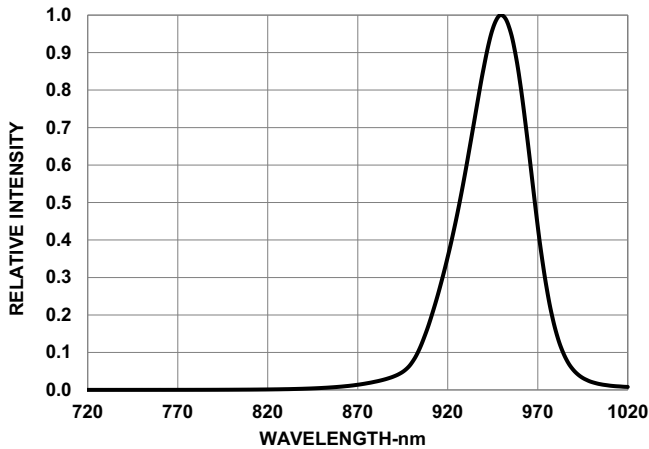
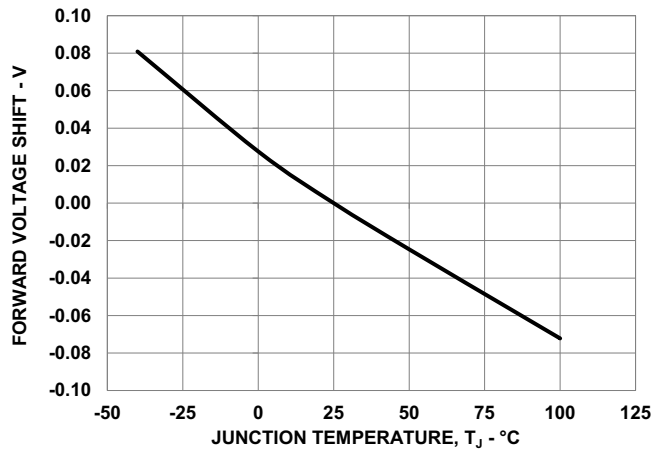

Figure 7: Forward Voltage Shift vs. Junction Temperature



## Precautionary Notes

### Soldering and Handling Precautions

- Set and maintain the wave soldering parameters according to the recommended temperature and dwell time. Perform a daily check on the profile to ensure that it is always conforming to the recommended conditions. Exceeding these conditions will over-stress the LEDs and cause premature failures.
- Use only bottom preheaters to reduce thermal stress experienced by the LEDs.
- Recalibrate the soldering profile before loading a new type of PCB. PCBs with different sizes and designs (component density) will have a different heat capacity and might cause a change in temperature experienced by the PCB if the same wave soldering setting is used.
- Do not perform wave soldering more than once.
- Any alignment fixture used during wave soldering must be loosely fitted and must not apply stress on the LEDs. Use non-metal material as it will absorb less heat during the wave soldering process.
- At elevated temperatures, the LEDs are more susceptible to mechanical stress. Allow the PCB to be sufficiently cooled to room temperature before handling. Do not apply stress to the LED when it is hot.
- Use wave soldering to solder the LED. Use hand soldering only for rework or touch up if unavoidable, but it must be strictly controlled to the following conditions:
  - Soldering iron tip temperature = 315°C maximum
  - Soldering duration = 2 seconds maximum
  - Number of cycles = 1 only
  - Power of soldering iron = 50W maximum
- For ESD-sensitive devices, apply proper ESD precautions at the soldering station. Use only ESD-safe soldering iron.
- Do not touch the LED package body with the soldering iron except for the soldering terminals as it may cause damage to the LED.
- Confirm beforehand whether the functionality and performance of the LED is affected by soldering with hand soldering.
- Keep the heat source at least 1.6 mm away from the LED body during soldering.
- Design the appropriate hole size to avoid problems during insertion or clinching (for auto-insertable devices).

Figure 8: Recommended PCB Through Hole Size

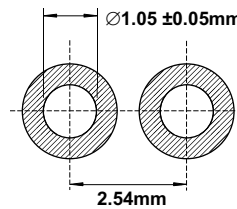
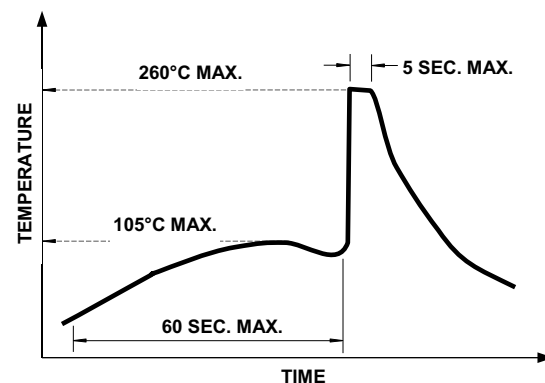

Figure 9: Recommended Wave Soldering Profile



**NOTE:** Refers to measurements with thermocouple mounted at the bottom of the PCB.

Refer to Application Note AN 5334 for more information on the soldering and handling of TH LED lamp.

### Lead Forming

- To pre-form or cut the leads prior to insertion and soldering onto the PCB, use the proper tool instead of doing it manually.
- Do not bend the leads at the location less than 3 mm from the LED body.
- Do not use the base of the LED body as a fulcrum for lead bending. Secure the leads properly before bending.
- If manual lead cutting is unavoidable, cut the leads after soldering to reduce stress to the LED body.

## Application Precautions

- The drive current of the LED must not exceed the maximum allowable limit across temperature as stated in the data sheet. Constant current driving is recommended to ensure consistent performance.
- Circuit design must cater to the whole range of forward voltage ( $V_F$ ) of the LEDs to ensure the intended drive current can always be achieved.
- The LED exhibits slightly different characteristics at different drive currents, which may result in a larger variation of performance (meaning: intensity, wavelength, and forward voltage). Set the application current as close as possible to the test current to minimize these variations.
- The LED is not intended for reverse bias. Use other appropriate components for such purposes. When driving the LED in matrix form, ensure that the reverse bias voltage does not exceed the allowable limit of the LED.
- Avoid rapid change in ambient temperature, especially in high-humidity environments, because they cause condensation on the LED.
- If the LED is intended to be used in a harsh or an outdoor environment, protect the LED against damages caused by rain water, water, dust, oil, corrosive gases, external mechanical stresses, and so on.

## Eye Safety Precautions

LEDs may pose optical hazards when in operation. Do not look directly at operating LEDs because it might be harmful to the eyes. For safety reasons, use appropriate shielding or personal protective equipment.

## Disclaimer

Broadcom's products and software are not specifically designed, manufactured, or authorized for sale as parts, components, or assemblies for the planning, construction, maintenance, or direct operation of a nuclear facility or for use in medical devices or applications. The customer is solely responsible, and waives all rights to make claims against Broadcom or its suppliers, for all loss, damage, expense, or liability in connection with such use.

Copyright © 2022-2023 Broadcom. All Rights Reserved. The term "Broadcom" refers to Broadcom Inc. and/or its subsidiaries. For more information, go to [www.broadcom.com](http://www.broadcom.com). All trademarks, trade names, service marks, and logos referenced herein belong to their respective companies.

Broadcom reserves the right to make changes without further notice to any products or data herein to improve reliability, function, or design. Information furnished by Broadcom is believed to be accurate and reliable. However, Broadcom does not assume any liability arising out of the application or use of this information, nor the application or use of any product or circuit described herein, neither does it convey any license under its patent rights nor the rights of others.



Lead (Pb) Free  
RoHS Compliant