

FEATURES

- Enables Vibration Energy Harvesting
- Robust Piezo Packaging
- Pre-Attached Electrical Lead Wires and Connector
- Hermetically Sealed for Use in Harsh Environments
- Low Profile
- Available in Different Sizes to Match to Application
- Directly Integrate with COTS Products Such As The Linear LTC3588 and Thin Film Batteries

APPLICATIONS

- Industrial Health Monitoring Network Sensors
- Condition Based Maintenance Sensors
- Wireless HVAC Sensors
- Mobile Asset Tracking
- Tire Pressure Sensors
- Oil and Gas Sensors
- All Air, Land and Sea Vehicle Sensors
- Battery and Hard Wired Power Replacement

DESCRIPTION

Vulture™ vibration energy harvesters convert otherwise wasted energy from mechanical vibrations into useable electrical energy. The Vulture™ accomplishes this by utilizing normally brittle piezoelectric materials. The Midé Vulture™ energy harvester is unique amongst other piezo based energy harvesters because it incorporates Midé's patented piezoelectric transducer packaging technology.

Through a proprietary manufacturing process, the Vulture™ packages piezoelectric materials in a protective skin with pre-attached electrical leads, producing a robust component with no soldered wires. The Vulture's™ protective skin also provides electrical insulation and defense against humidity and harsh contaminants.

The Vulture™ is available in six standard sizes. Custom sizes are available and a cost effective alternative.

If a custom size is required please contact Midé Technology Corporation by emailing: vulture@mide.com.

TYPICAL APPLICATION

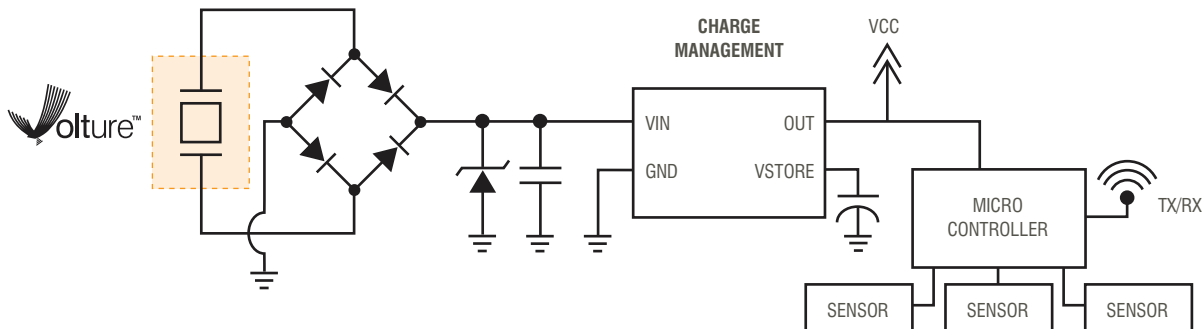

PRODUCT DIMENSIONS

NOTE:

1. All dimensions are in inches
2. Connector thickness = 0.100"

Product	Typical Thickness (in)
V20W	0.034
V25W	0.024
V21B	0.031
V21BL	0.031
V22B	0.031
V22BL	0.031

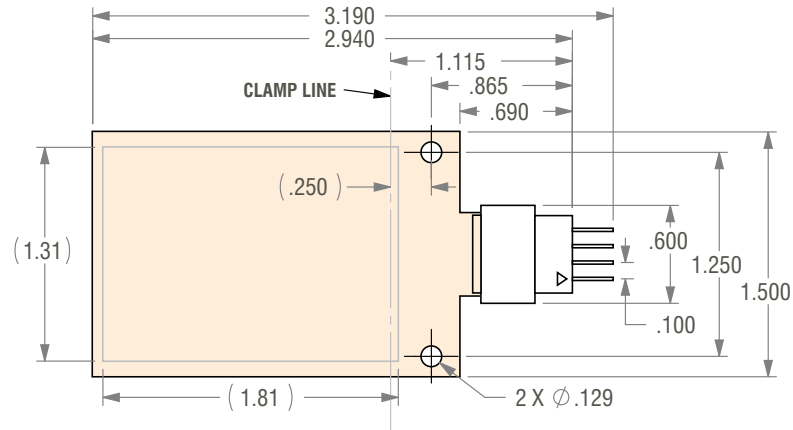

**V20W
V25W**

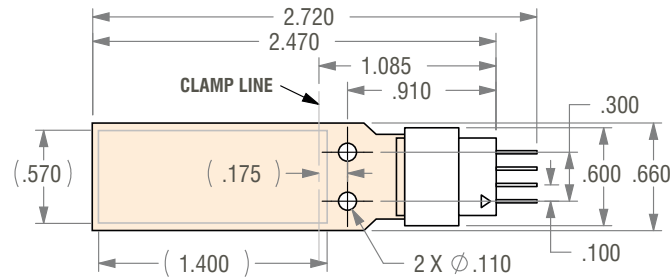

V21B

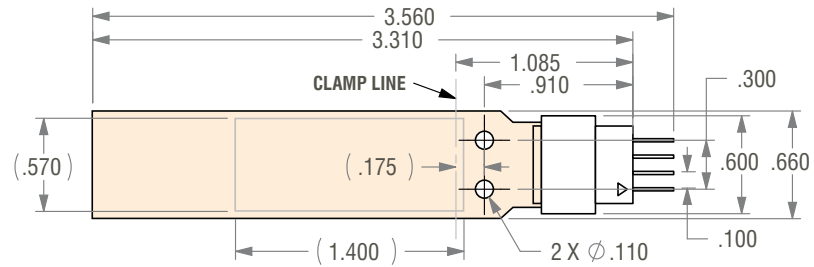

V21BL

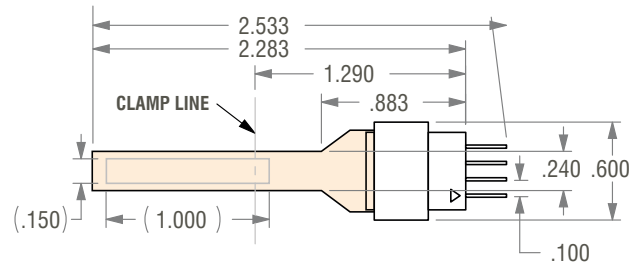

V22B

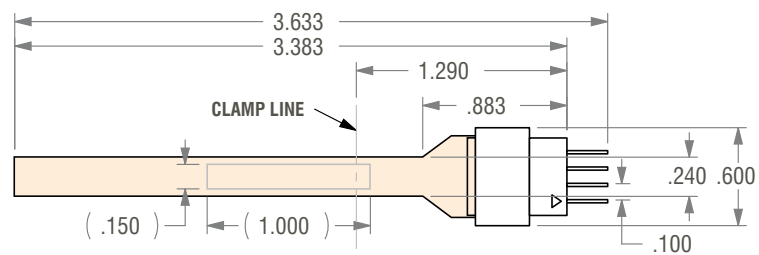

V22BL

ABSOLUTE MAXIMUM RATINGS

Operating Temperature Range	-40 to 90 C
Operating Temperature Range (Without Connector)	-40 to 150 C
Storage Temperature Range	-60 to 90 C
Storage Temperature Range (Without Connector)	-60 to 150 C
Lead Temperatures (Soldering, 10 sec)	300 C
Piezo Strain, max	800 micro-strain*
Maximum Voltage Output	Product and Vibration Dependent**
Maximum Current Output	Product and Vibration Dependent**
**See Performance Curves For Typical Values	
*Related to max. tip deflection, see Deflection Limits	

DEFLECTION LIMITS

Energy Harvester Product Number	Max. Tip-to-Tip Displacement (in)
V20W	0.10
V25W	0.15
V21B	0.06
V21BL	0.18
V22B	0.03
V22BL	0.12

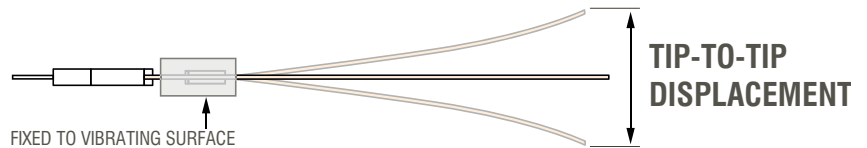

ELECTRICAL CHARACTERISTICS

Product	Single Wafer Series Capacitance (nF), measured at 100 Hz	Single Wafer Series Resistance (Ohm), measured at 100 Hz	Single Wafer Series Capacitance (nF), measured at 120 Hz	Single Wafer Series Resistance (Ohm), measured at 120 Hz
V20W	69	390	69	340
V25W	130	210	130	175
V21B	26	950	26	770
V21BL	26	950	26	770
V22B	9	2400	9	2000
V22BL	9	2400	9	2000

PIN FUNCTIONS

P1, P2: Piezo wafer 1 output

P3, P4: Piezo wafer 2 output

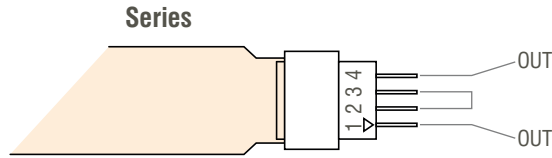

Series

Compared to Single Wafer Value
Double Voltage
Same Current
Capacitance: Half the Single-Wafer Value

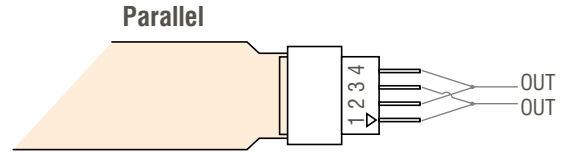

Parallel

Compared to Single Wafer Value
Same Voltage
Doubled Current
Capacitance: 2x the single-wafer value

Each Vulture contains two electrically isolated piezo wafers, which may be used independently or bridged for increased voltage (series configuration) or current output (parallel configuration). Series connection will double the open-circuit voltage compared to a single wafer, and the effective capacitance will be 1/2 the single-wafer capacitance listed in the “Electrical Characteristic Table (Pg. 3)”. Parallel connection will double the current compared to a single wafer, and the effective capacitance will be double the single-wafer value. For most applications, parallel connection is

recommended. Please refer to the connection diagram above. Regardless of series or parallel connection, the power generated by the Vulture™ Energy Harvester will be the same.

In typical energy harvesting usage, the raw output is an AC waveform as the Vulture deflects in both directions. For sensing or dual-use applications where it is desired to know the direction of deflection at any given time, please refer to the relationship between deflection and output polarity for each wafer diagram below.

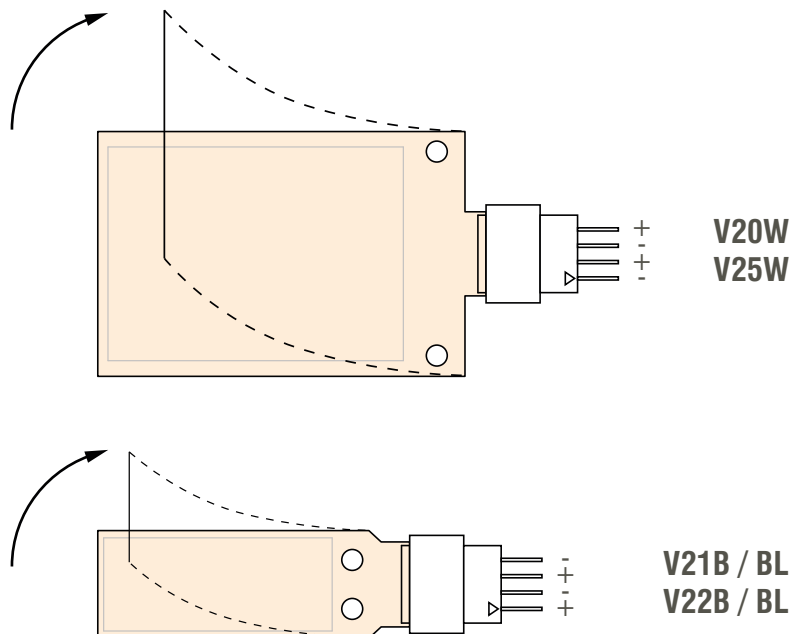

OPERATION

The Vulture™ vibration energy harvester is designed to extract useable electrical energy from waste mechanical vibrations. The best means to accomplish this is to mount the Vulture™ product in a cantilevered configuration on the vibration source and tune the natural frequency of the Vulture™ harvester to match that of the vibration source.

Vibration Source Characterization

The first step in successful energy harvesting is to fully understand the vibration environment in which the Vulture™ will be operating. The most effective means to accomplish this is to measure the vibration using an accelerometer, capture the data, and perform an FFT (Fast Fourier Transform) on the data to extract the relevant frequency information.

Some applications will not require this step since their dominant frequencies are inherently known. An example of this would be a 120 Hz AC motor or a 60 Hz appliance. However, most applications will require some form of vibration characterization to be successful.

Midé offers a vibration characterization product and service, the VR001. The VR001 is a small device that can be easily installed into many different vibration environments. The device is completely stand alone and can be applied to hard to reach areas. Built in timer delays allow for capture of many different types of vibration environments. A simple USB interface with

provided software allows the user to easily characterize any vibration.

Attaching And Clamping The Vulture™

For optimized energy harvesting from vibrations it is best to mount the Vulture™ products in a cantilevered configuration. This takes advantage of resonant beam harvesting. If the natural frequency of the Vulture™ is successfully tuned to that of the vibration source, the most energy will be harvested.

The first step in successful clamping is to ensure that both the base and clamp are constructed of rigid materials completely free of burrs and defects. Using a rigid material will minimize dissipation of energy through the clamp structure and avoiding burrs and defects will minimize the potential for stress concentrations on the Vulture™ which could lead to premature failure.

The clamp should completely extend beyond the piezo element within the Vulture product. The suggested clamp line shown in the product dimensions section of this document ensures that the clamp is clamping on the piezo element.

For long term installation, the fasteners used to secure the clamp should be properly torqued and should be reinforced either using lock washers or some kind of locking adhesive. This will ensure a proper long term clamp that will not loosen over time.

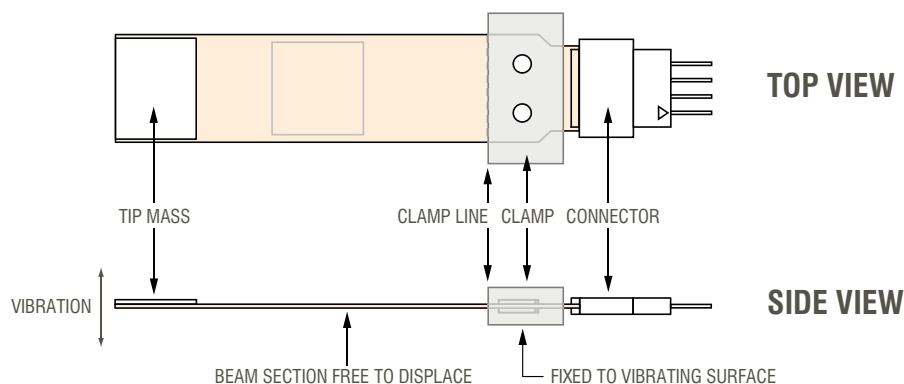

OPERATION

Straight clamps are the simplest and often most cost effective clamps. However, curved clamps, as shown in the diagram below, have shown the capability to slightly increase performance of the Vulture. Straight clamps are sufficient for the majority of applications.

Tuning The Vulture™

To ensure the most efficient harvesting, it is essential to tune the Vulture's™ natural frequency to match that of the vibrating source. Tuning is performed by adding a tuning mass to the end of the cantilevered Vulture™

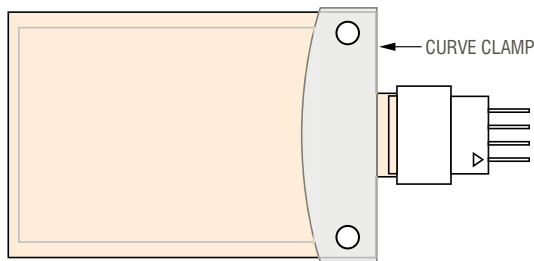

until the natural frequency of the piezo beam is the same as the vibration source. The larger the tuning mass the lower the natural frequency of the Vulture™.

For non permanent installations or for active tuning it is best to use bee's wax or some other form of non-permanent attachment for the tuning mass to the Vulture. Bee's wax allows the mass to be moved along the beam, toward and away from the clamp, for tuning.

There are multiple means of tuning the Vulture™ depending on the equipment available to the user. If only the vibration source that will ultimately be harvested from is available to the user, it is recommended that the Vulture™ be properly mounted and clamped to the vibration source. The output of the Vulture should then be attached to an oscilloscope for monitoring. The output can be either the raw output of the Vulture™ (directly on two of the output pins) or through whatever electronics the user is using so long as the electronics allow for some measure of optimal

power output. The tuning mass can then be adjusted until the maximum power is achieved.

If the user has a shaker available, the tuning can be performed by driving the Vulture™ at the desired natural frequency and adjusting the mass until optimal power output is achieved. If connecting directly to the Vulture™ pins, optimal power output will be where the voltage output is maximized.

Another simple way to tune your Vulture™ product is to measure the frequency at which the device "rings out" when excited by an impulse mechanical load. The easiest way to perform this type of tuning is to properly mount and clamp the Vulture to a rigid structure. Next, attach at least one of the piezo's within the Vulture directly to an oscilloscope for monitoring (ex: connect to pins P1 and P2). Add the appropriate tip mass (See RELATION BETWEEN TIP MASS & NATURAL FREQUENCY section) to the end of the cantilevered Vulture, do not permanently adhere the tip mass yet. Bee's wax or tape is often the best material to use for non permanent tip mass installations. Apply an impulse mechanical load by very lightly "flicking" the end of the Vulture. This will cause the beam to "ring out". The frequency of the the decaying wave is the natural frequency that the Vulture is currently tuned to. To decrease this frequency move the mass farther away from the clamp point, to increase the frequency move the mass closer to the clamp point. If the natural frequency is not close to the desired frequency either a different tip mass or a different product may be required.

Once the tip mass is in the proper location for optimal energy harvesting it should be permanently adhered to the Vulture™. This ensures that the tip mass remains in place for the life of the Vulture™. It is recommended that a robust adhesive such as Loctite™ 404 be used for this permanent installation. Keep in mind that any added mass will impact the tuning of the system.

POWER MEASUREMENTS

Piezoelectric material produces mechanical strain under the influence of an externally applied electrical field, and conversely produces electrical potential in response to applied mechanical strain. Products such as the Vulture™ piezo energy harvester are typically used in a cantilevered-beam configuration, in which the piezoelectric beam is clamped at one end and the other end allowed to oscillate freely in response to vibration normal to the flat surface of the beam, converting these vibrations to in-plane material strain. The beam dimensions and tip mass determine the resonant frequency of the beam, which is tuned to match the dominant vibrational frequency of its environment, mechanically amplifying this typically small vibration.

Power Measurements

The power output capability of the Vulture™ products was measured in the following manner. In the cantilevered beam configuration above, the Vulture was mounted to a shaker capable of generating vibrations of varying frequency and amplitude. Tip masses (four for each product) were added to alter the natural frequency of the Vulture™ products. The vibration frequency being generated by the shaker was then matched to the frequency of the Vulture™ product to provide resonant and therefore optimized energy harvesting. Four different amplitudes were tested (0.25, 0.375, 0.5, and 1.00g) at each of these frequencies. The piezo's output was rectified and then placed across a purely capacitive load. The capacitor value was chosen using the following equation for average power, where C is the

capacitance in Farads, V is the piezo's open circuit voltage, and Δt is a reasonable time interval (~ 10 seconds), and solving for C:

$$P_{AVG} = \frac{1}{2} C \cdot V^2 \cdot \Delta t$$

Yielding:

$$C = \frac{2 \cdot P_{AVG} \cdot \Delta t}{V^2}$$

The figure below shows the voltage (operating voltage) on the capacitor and instantaneous power into capacitor vs. time for a representative vibration level and frequency. The V25W product was used, demonstrating that the power increases until it peaks when the operating voltage is at about half its open circuit value. After that, it decreases.

See Application Note: Load Isolation Example.

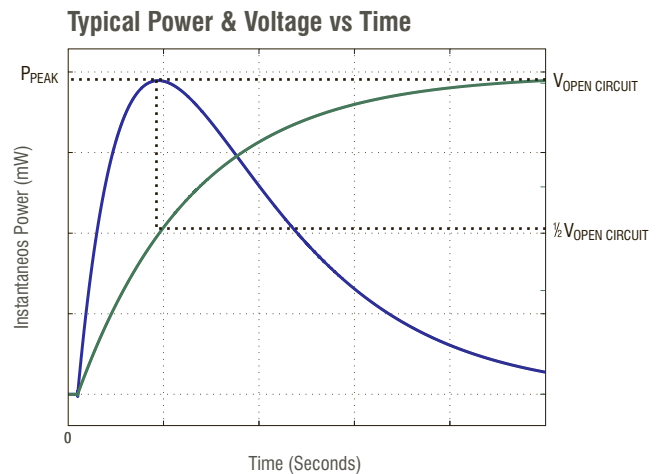



V2OW TYPICAL PERFORMANCE POWER CHARACTERISTICS

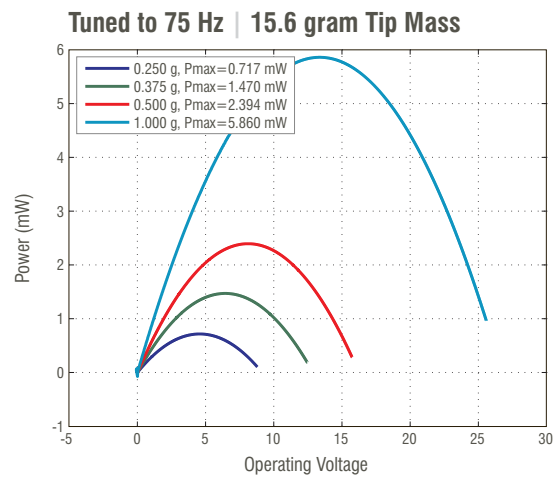
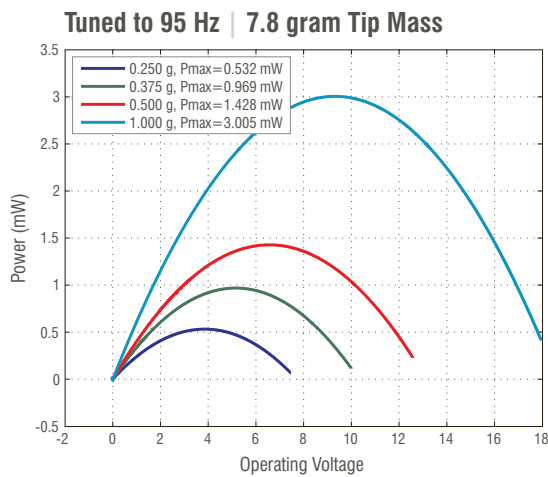
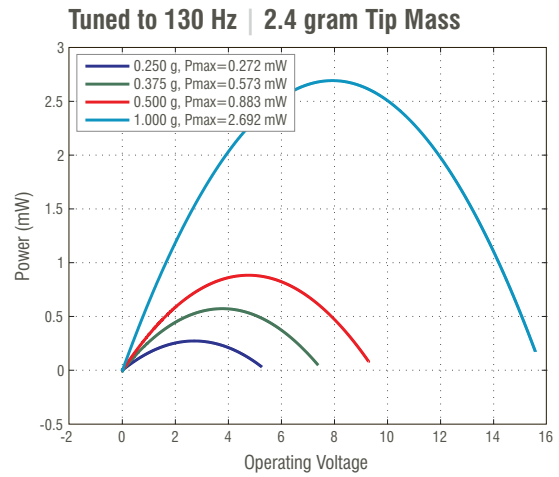
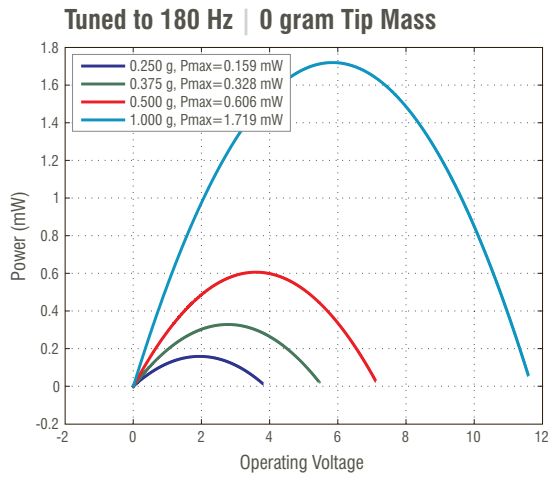

V2OW RELATION BETWEEN TIP MASS & NATURAL FREQUENCY

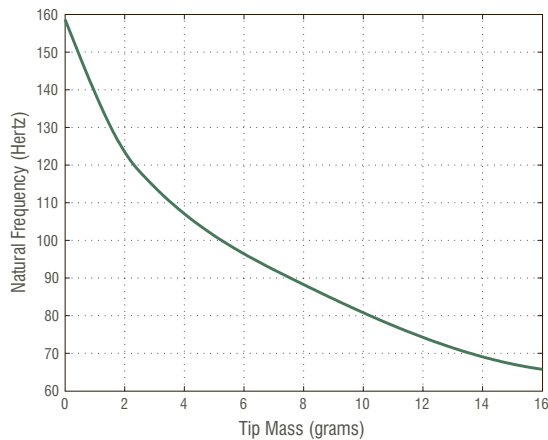

Tip Mass (gram)	F_n (Hz)	Amplitude (g)	Open Circuit Voltage*
0	180	0.25	4.7
0	180	0.375	6.5
0	180	0.5	7.7
0	180	1	12.8
2.4	130	0.25	6.7
2.4	130	0.375	9
2.4	130	0.5	11
2.4	130	1	18
7.8	95	0.25	8.3
7.8	95	0.375	11.8
7.8	95	0.5	16.4
7.8	95	1	23.1
15.6	75	0.25	13.3
15.6	75	0.375	19
15.6	75	0.5	22.6
15.6	75	1	34.7

* piezo wafers connected in series

V25W TYPICAL PERFORMANCE POWER CHARACTERISTICS

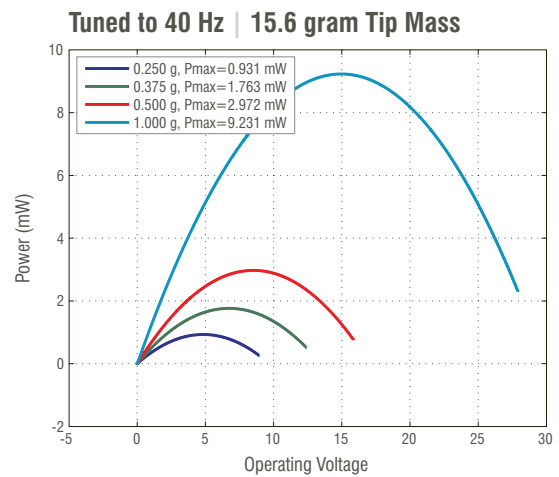
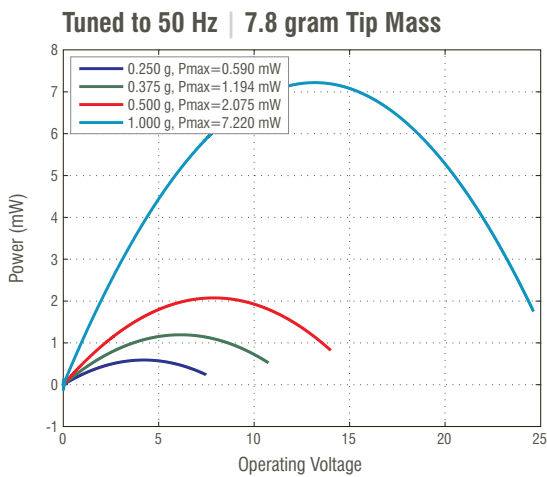
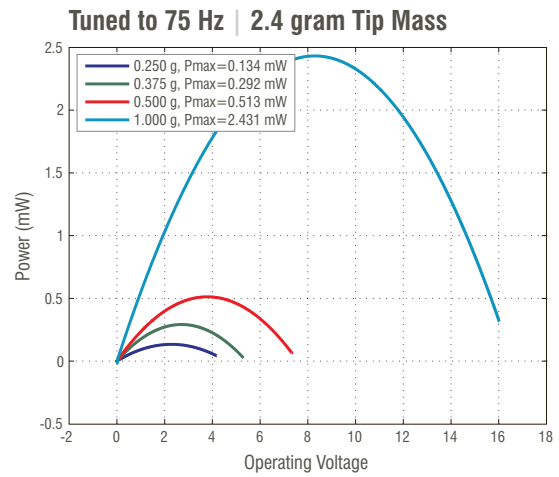
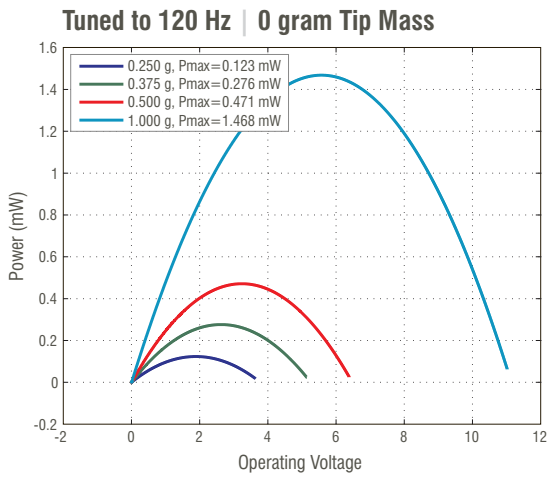

V25W RELATION BETWEEN TIP MASS & NATURAL FREQUENCY

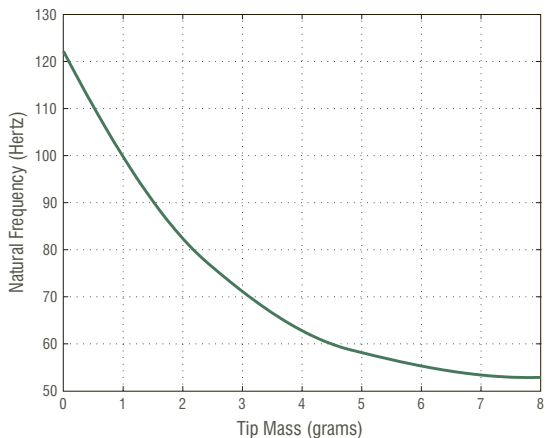

Tip Mass (gram)	F_n (Hz)	Amplitude (g)	Open Circuit Voltage*
0	120	0.25	3.2
0	120	0.375	4.4
0	120	0.5	5.5
0	120	1	10.1
2.4	75	0.25	4.7
2.4	75	0.375	6.5
2.4	75	0.5	7.5
2.4	75	1	11.5
7.8	50	0.25	10.3
7.8	50	0.375	15.4
7.8	50	0.5	18.6
7.8	50	1	29.5
15.6	40	0.25	14.5
15.6	40	0.375	21.2
15.6	40	0.5	27
15.6	40	1	36.6

* piezo wafers connected in series

V21B TYPICAL PERFORMANCE POWER CHARACTERISTICS

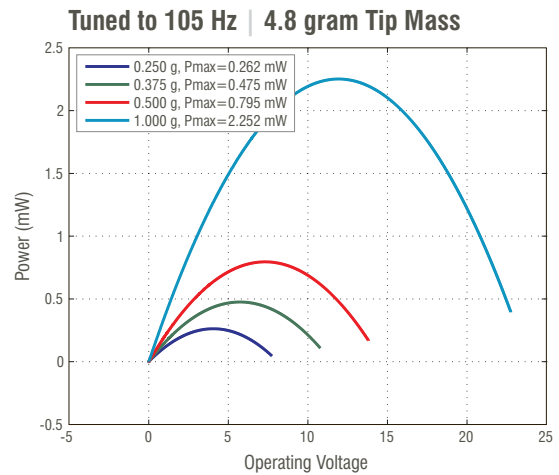
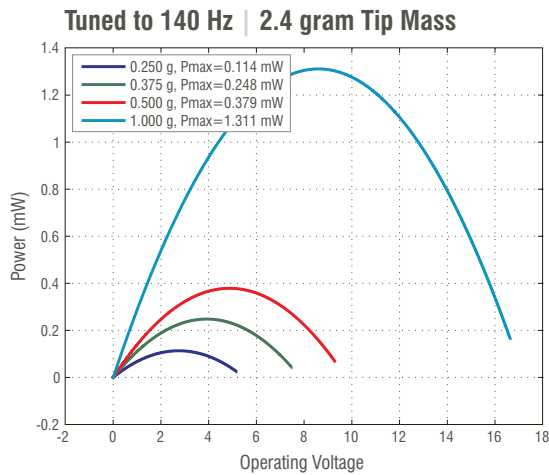
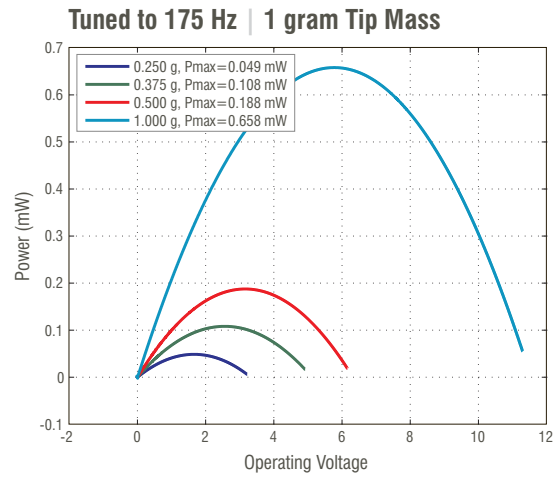
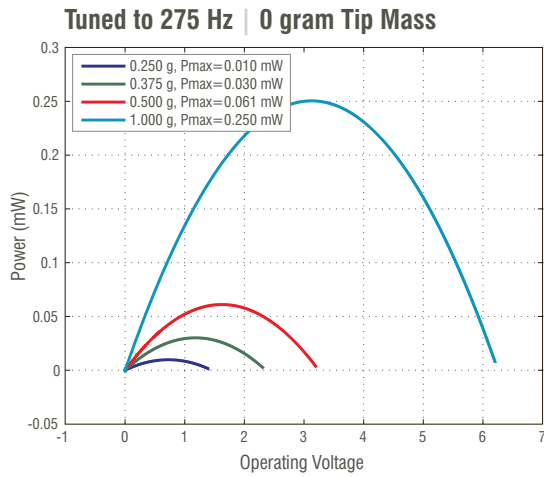

V21B RELATION BETWEEN TIP MASS & NATURAL FREQUENCY

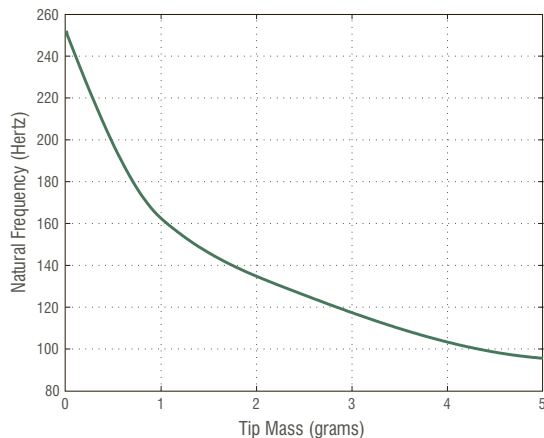

Tip Mass (gram)	F_n (Hz)	Amplitude (g)	Open Circuit Voltage*
0	275	0.25	4.1
0	275	0.375	5.9
0	275	0.5	7.6
0	275	1	12.3
1	175	0.25	7.6
1	175	0.375	10.9
1	175	0.5	13.6
1	175	1	23.5
2.4	140	0.25	10.9
2.4	140	0.375	15.2
2.4	140	0.5	18.8
2.4	140	1	32
4.8	105	0.25	15.9
4.8	105	0.375	21.6
4.8	105	0.5	28.1
4.8	105	1	46.5

* piezo wafers connected in series

V21BL TYPICAL PERFORMANCE POWER CHARACTERISTICS

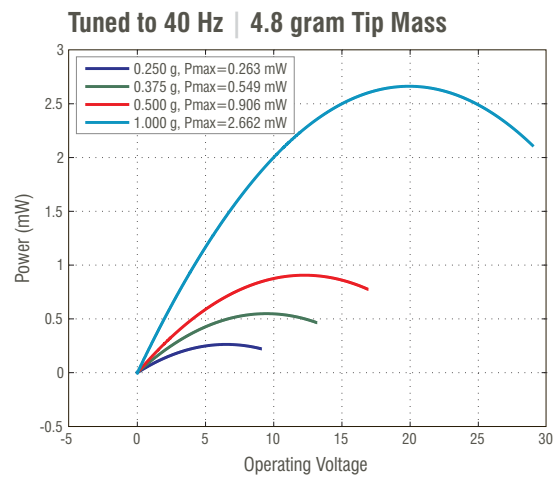
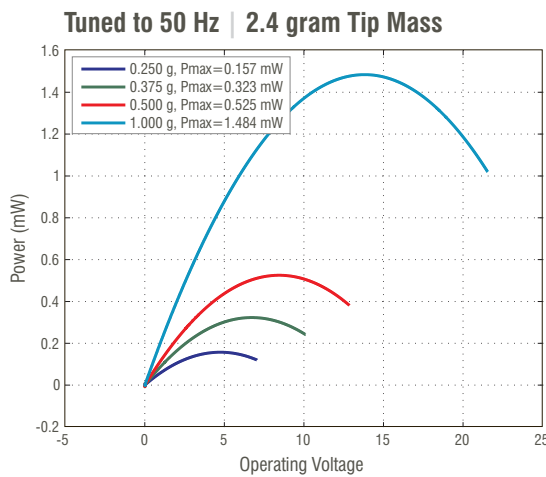
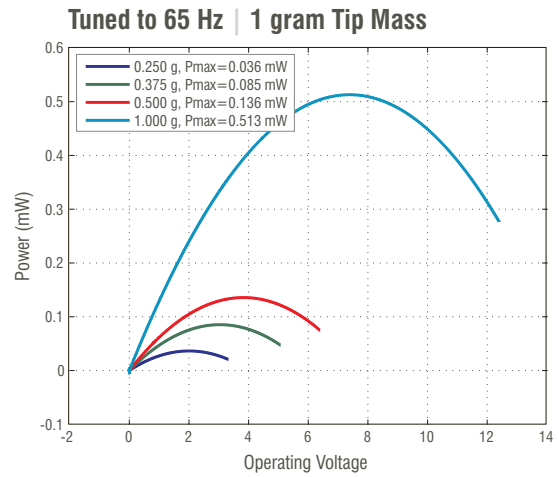
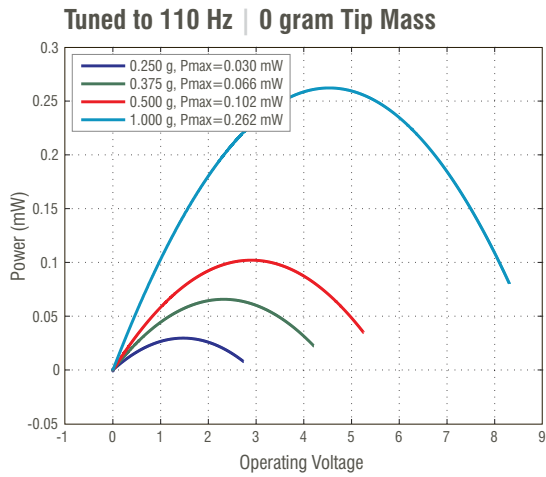

V21BL RELATION BETWEEN TIP MASS & NATURAL FREQUENCY

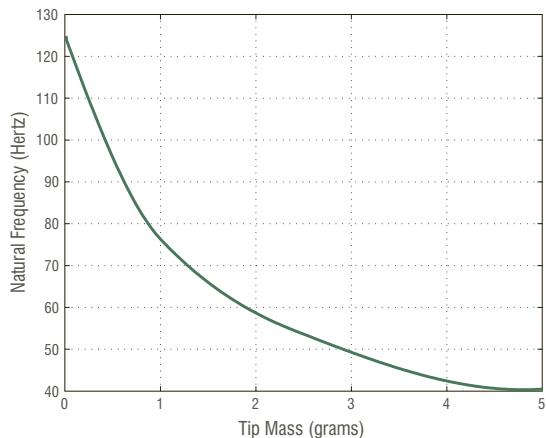

Tip Mass (gram)	F_n (Hz)	Amplitude (g)	Open Circuit Voltage*
0	110	0.25	3.95
0	110	0.375	5.35
0	110	0.5	6.6
0	110	1	12.1
1	65	0.25	8
1	65	0.375	9.9
1	65	0.5	12.4
1	65	1	22.1
2.4	50	0.25	9.8
2.4	50	0.375	13.7
2.4	50	0.5	19.1
2.4	50	1	27.5
4.8	40	0.25	13.2
4.8	40	0.375	19.2
4.8	40	0.5	25.9
4.8	40	1	44.4

* piezo wafers connected in series

V22B TYPICAL PERFORMANCE POWER CHARACTERISTICS

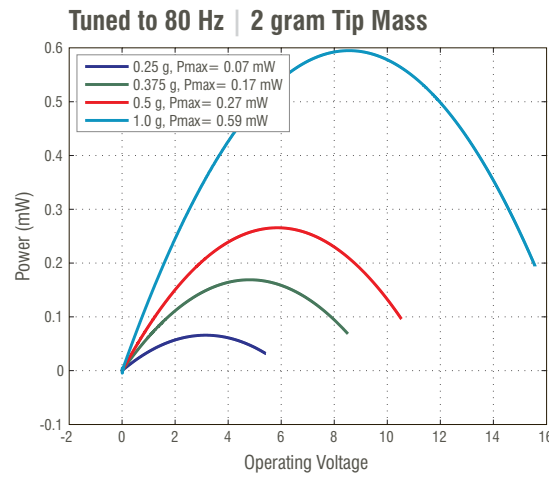
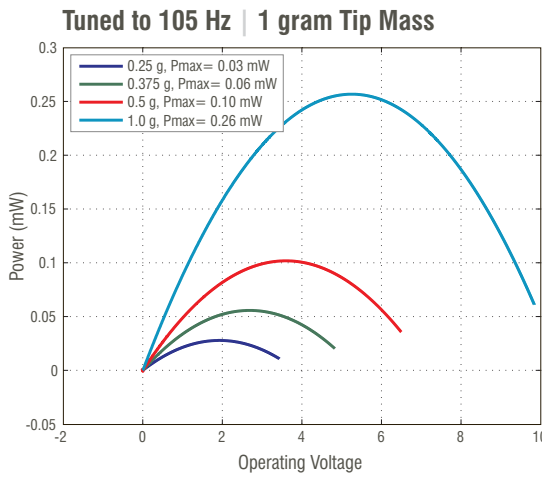
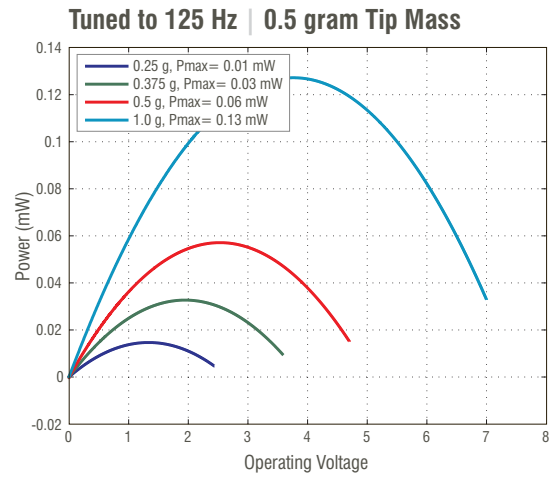
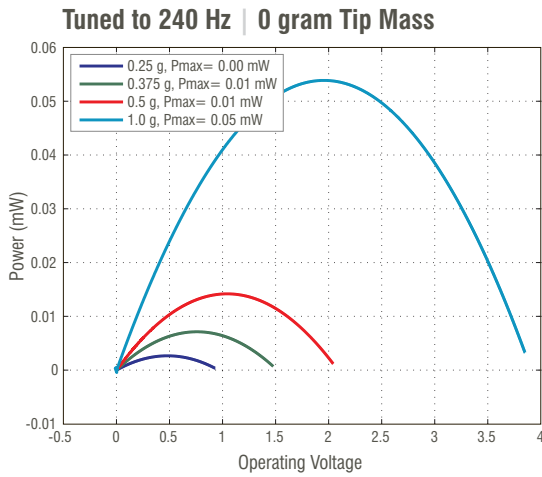

V22B RELATION BETWEEN TIP MASS & NATURAL FREQUENCY

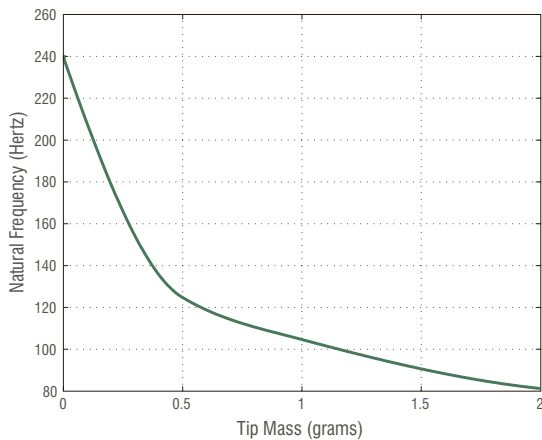

Tip Mass (gram)	F_n (Hz)	Amplitude (g)	Open Circuit Voltage*
0	240	0.25	2.2
0	240	0.375	3.4
0	240	0.5	4.6
0	240	1	7.2
0.5	125	0.25	6.7
0.5	125	0.375	9.3
0.5	125	0.5	11.6
0.5	125	1	18.5
1	105	0.25	9
1	105	0.375	12.1
1	105	0.5	14.7
1	105	1	25.1
2	80	0.25	13
2	80	0.375	17.4
2	80	0.5	22.3
2	80	1	33.4

* piezo wafers connected in series

V22BL TYPICAL PERFORMANCE POWER CHARACTERISTICS

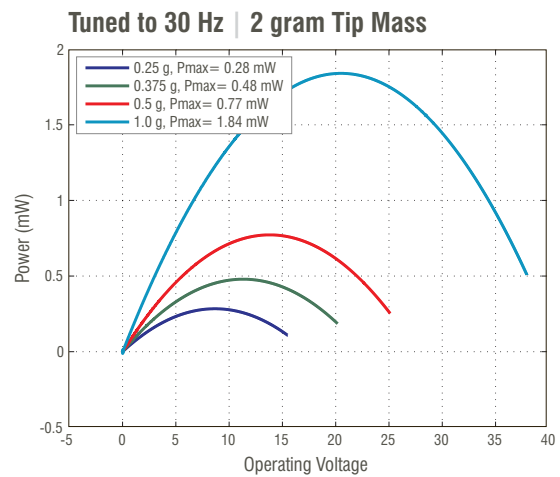
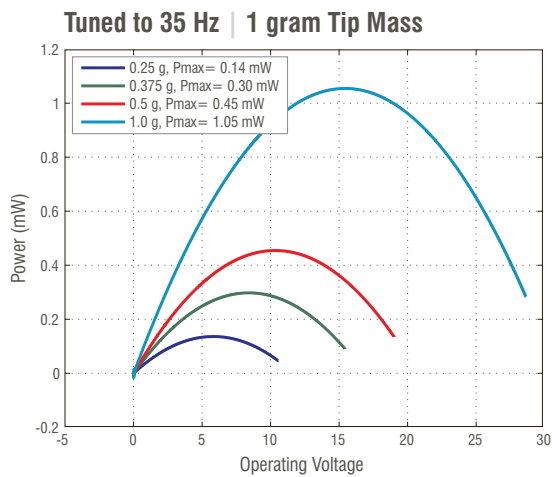
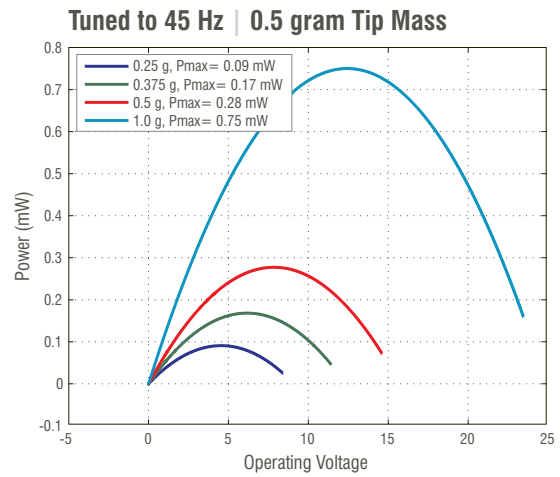
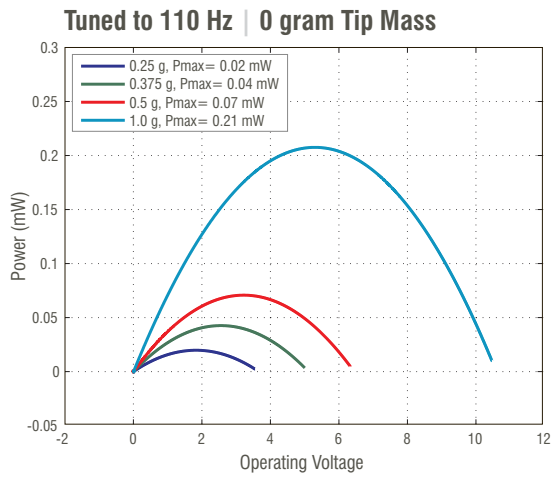

V22BL RELATION BETWEEN TIP MASS & NATURAL FREQUENCY

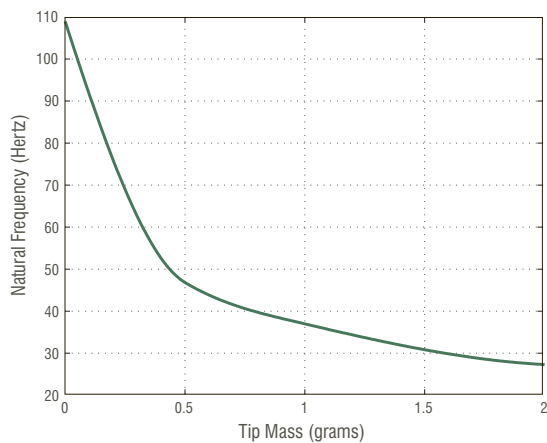

Tip Mass (gram)	F_n (Hz)	Amplitude (g)	Open Circuit Voltage*
0	110	0.25	2
0	110	0.375	3.1
0	110	0.5	4.2
0	110	1	6.9
0.5	45	0.25	6
0.5	45	0.375	8.5
0.5	45	0.5	11
0.5	45	1	17.5
1	35	0.25	8
1	35	0.375	11.5
1	35	0.5	14
1	35	1	23.4
2	30	0.25	12
2	30	0.375	16.1
2	30	0.5	20.8
2	30	1	31.8

* piezo wafers connected in series

APPLICATIONS INFORMATION - SWITCHED CAPACITOR BOOST CIRCUIT

Switched Capacitor Boost Circuit for One-Shot Sensors and Low Vibration Levels

It is often difficult to make use of low-voltage energy scavenging sources, such as piezo energy harvesters at low vibration amplitudes, solar cells in overcast or indoor environments, or Seebeck devices, etc., as most microcontrollers and sensors require minimum voltages of 1.8V or greater to operate. Using these sources requires a voltage boost converter with a minimum start-up voltage, low start-up current requirement, and graceful handling of undervoltage and slow input voltage rise times.

The circuit shown, based on the Seiko Epson S-882Z series charge pump IC, provides bursts of power starting at approximately 2.4VDC (ending at 1.6-2 VDC) from input voltages as low as approximately 380mV. This IC provides boosting using small on-chip switched (“flying”) capacitors, rather than inductive boost conversion. Thus the initial input current requirements are reduced compared to a typical boost converter, requiring only a small power-supply

bypass capacitance to reliably start up. The circuit can begin operating almost immediately when power becomes available. This circuit is ideal for directly powering small sensors that can perform their function (e.g. record or transmit a measurement) in a known amount of time and power. It could also be used to extend battery life, or as a trigger source for devices with their own battery/supercap power source.

When the voltage at VIN exceeds the minimum start-up voltage, the IC begins pumping charge to a storage capacitor connected across the CPOUT pin. When the capacitor voltage reaches 2.4V, the output is enabled and this voltage is applied to the load. The load is automatically disconnected when the storage capacitor voltage drops below approx. 1.8V (see Figure 6). This behavior allows the circuit to directly power most 3.3V microcontroller circuits, with a typical operating voltage range of 1.8V ~ 3.6V, without exposing the circuit to significant undervoltage or unfavorable voltage rise-time conditions.

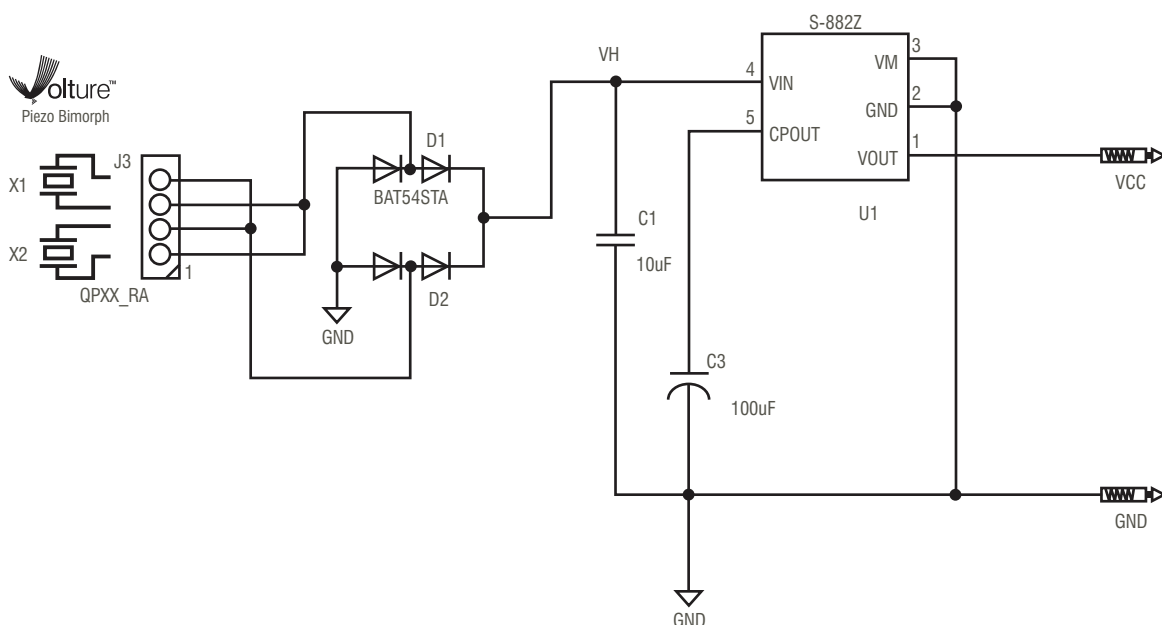

APPLICATIONS INFORMATION - SWITCHED CAPACITOR BOOST CIRCUIT

Goals

- Allow intermittently operating circuits to be powered from extremely weak vibration sources, or moderate vibration sources at frequencies significantly different from the energy harvester's resonant frequency (Figure 3)
- Physically disconnect the load during periods of insufficient voltage to avoid "over-the-hump" problems of cold circuit start-up from harvested power
- Maximize chances of success where vibration source's characteristics (amplitude and frequency content) cannot be known in advance.

Simple "One-Shot" Application

A simple usage scenario is an embedded sensor with data storage/transmission capability, which takes one set of measurements each time it is powered up (relying on the loss and subsequent re-application of power to start the next measurement). In this case, the measurement frequency is variable and depends on the vibration amplitude. To operate the sensor directly from the boost circuit requires:

- Estimation (or measurement of) the run-time and power consumption of your application within its voltage limits
- Sizing the CP_{out} according to worst-case usage, allowing some headroom

For such one-shot sensors, it is recommended to create a large load (e.g. drive an LED or GPIO pin tied to ground) after completing the task in order to ensure the power output cycles in high-vibration conditions.

A typical microcontroller sensor application's load profile will be "bursty", complicating the task of estimating the required value of CP_{out} . However, if the load can be approximated in terms of a resistive load, the following equations can be used to estimate the required capacitance, available runtime, energy per discharge or power stored.

$$C = \frac{1}{\frac{1}{T_d} R \cdot \ln \frac{V_0}{V}}$$

Equation 1: Capacitance needed for a given runtime (F)

$$T_d = R \cdot C \cdot \ln \frac{V_0}{V}$$

Equation 2: Runtime for a given capacitance (sec.)

$$W = \frac{1}{2} C (V_0^2 - V^2)$$

Equation 3: Energy per discharge (Joules or watt-seconds)

$$P = \frac{W}{T_c + T_d}$$

Equation 4: Average Power (Watts)

In the equations above, T_d is the runtime or discharge time in seconds, T_c is the charge time in seconds, R is the equivalent load resistance in ohms, V_0 is the starting output voltage (2.4), V is the final output voltage (1.8V or the minimum operating voltage of the sensor, whichever is greater), and C is the capacitance in Farads. Likewise, the output voltage can be modeled as a simple RC time constant, $V = V_0 e^{-T/RC}$.

Continuously-Powered Application with Input-Dependent Triggering

Sometimes it may be advantageous to incorporate vibration-powered battery maintenance and/or triggering into a continuously-running circuit. For example, a sensor may require low-level continuous power to maintain a realtime clock, but measurement tasks are only needed when a piece of machinery is known to be operating. Alternately, it may be desired to dynamically adjust the measurement rate based on the incoming power to maintain a given power budget. In

APPLICATIONS INFORMATION - SWITCHED CAPACITOR BOOST CIRCUIT

these cases, the application can use V_{out} as an interrupt source in addition to power source, with a rising or falling edge triggering the desired action.

Typical Results

The following are measured results using the circuit shown in a typical configuration.

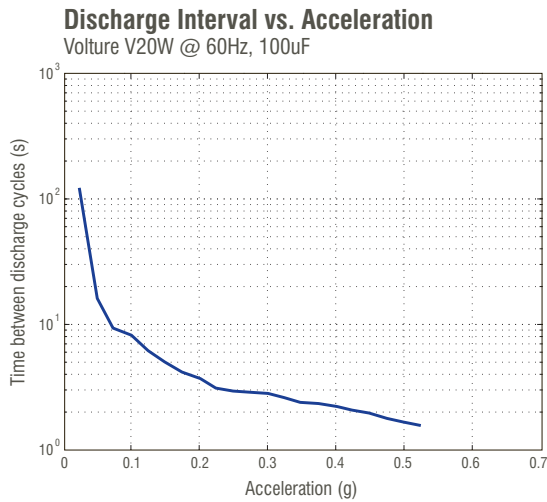

Figure 2: Discharge Interval vs. Acceleration, measured results using configuration shown

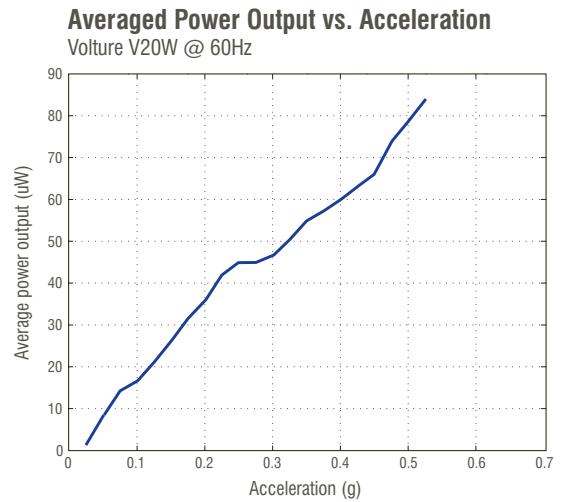

Figure 4: Averaged Power Output vs. Acceleration

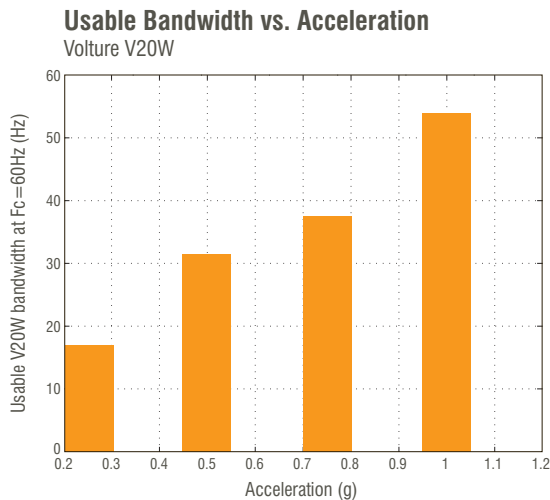

Figure 3: Usable Bandwidth vs. Acceleration at 60Hz center frequency. Usable bandwidth refers to the frequency range over which the setup produced voltages exceeding the circuit's turn-on threshold (2.4V), producing output pulses.

APPLICATIONS INFORMATION - SWITCHED CAPACITOR BOOST CIRCUIT

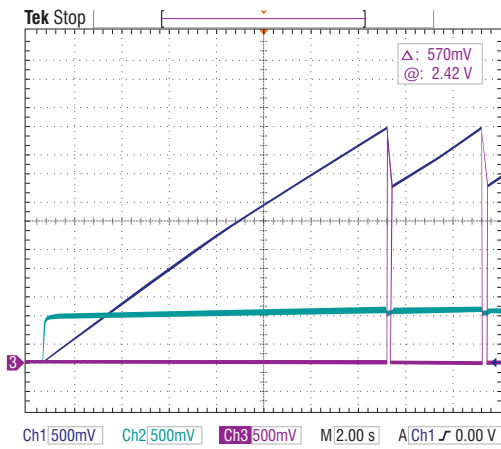

Figure 5: Rectified input (aqua), V_{CAP} (navy) and switched output (violet) from initial start-up to stable output, 10K resistive load.

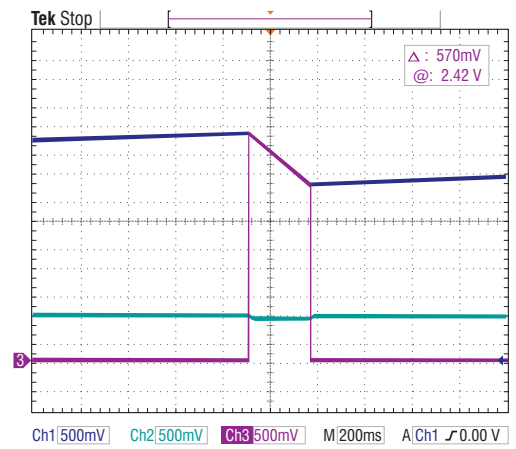

Figure 6: Rectified input (aqua), V_{CAP} (navy) and switched output (violet) output pulse detail, 10K resistive load.

APPLICATIONS INFORMATION - LOAD ISOLATION EXAMPLE

Load Isolation Example for Maximum Efficiency with Low-Impedance Loads

A cantilevered-beam piezoelectric energy harvester is a complex electromechanical system in which the electrical and mechanical loading of the beam are inter-related. Understanding of this relationship is critical to getting the most out of the system.

A properly tuned switched boost-buck circuit will always outperform any circuit in which you do not tune to the characteristics of its application. This application note demonstrates a high-efficiency switched step-down (buck) converter and optimizations for maximum performance in a real-world application. This circuit isolates the end-application's electrical load from the piezo beam, providing proper impedance-matching of the circuit's "virtual load" to the beam, as well as minimizing mechanical loading effects. Such a circuit is ideal for low-impedance loads such as rechargeable batteries, "bursty" loads such as intermittently-operating sensors/transmitters, and applications where the electrical load cannot be known in advance.

Basic Piezoelectric Beam Model

Before mechanical loading effects are taken into account, each piezo beam can be thought of as a small current source in parallel with a capacitor and parasitic resistance, as shown in Figure 1. Typical values for this parallel capacitance and resistance are on the order of 10nF and >40M, respectively. This parallel resistance is insignificant for our purposes and may be ignored. The current flow is equal to the derivative of the strain-induced charge, or dQ/dt . The voltage transfer function of each beam therefore is $V(s)/q(s) = sR/(1+sRC)$, where R is the parallel resistance and C is the parallel capacitance of the beam.

In its simplest form, power is drawn from a small capacitor which is constantly recharged by its

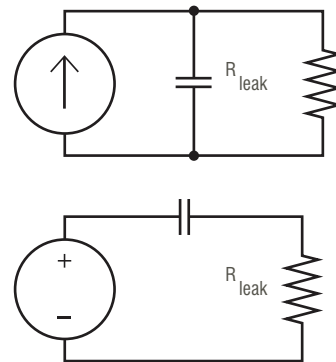

Figure 1: Piezo parallel and series equivalent circuits

environment. Care must be taken to choose when this power is drawn. To maximize transfer efficiency, the load must be matched to the piezo's equivalent impedance. In practice, the piezo impedance at a given amplitude and frequency, as well as the load impedance, can be thought of as a pair of simple (but unknown) resistances which make up a resistor divider. The power transfer between the two is optimized when their values match. This corresponds to the point at which the piezo's loaded voltage is equal to half its open-circuit voltage. Thus the impedance match can be optimized without formally measuring or knowing the impedance of the piezo source or load in-situ.

Implementation

The circuit of Figure 2 provides a simple but effective approach to meeting these goals.

The main components are a bridge rectifier formed by D1-D4, low-power comparator (U1) and buck converter (U2). During vibration, main storage capacitor C1 slowly charges until its voltage reaches the operating point ($V_{OC}/2$) set by R1 and R2. Buck converter U2 is enabled once the stored voltage exceeds this value plus a small hysteresis. At typical loads, the buck converter operation into the load will

APPLICATIONS INFORMATION - LOAD ISOLATION EXAMPLE

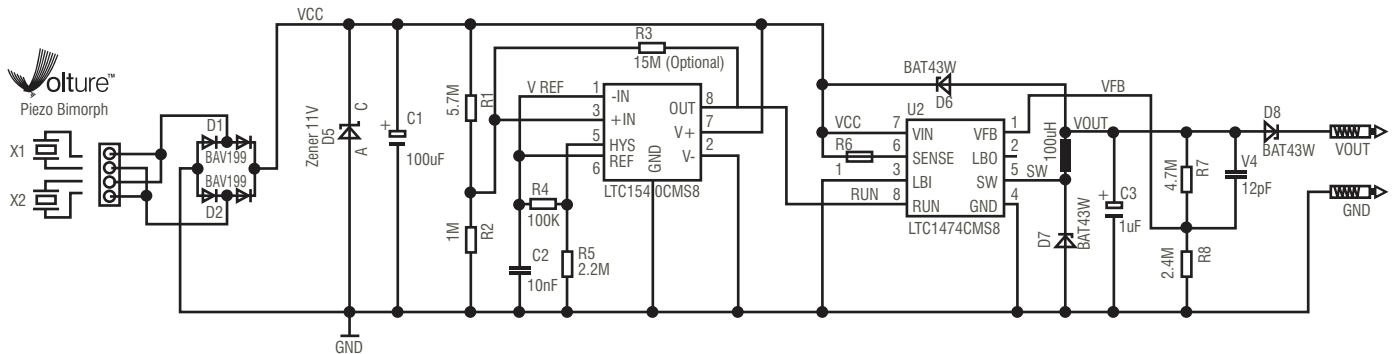

Figure 2: Simple high-efficiency voltage conversion and load-isolation circuit for piezo energy harvesting applications. The C1 voltage setpoint in this example is fixed, but could be made adaptive using additional circuitry.

deplete C1 until its voltage drops below the hysteresis band, at which point the converter is disabled and the cycle repeats. Thus C1 is maintained at approximately $V_{OC}/2$. The typical output is a train of voltage-regulated pulses ideally suited to charging a battery or capacitor, or directly powering an intermittently-operating sensor.

Since the voltage at C1 is held approximately constant, the effective load seen by the piezo is not significantly affected by activation of U2 or changes to the actual load. Additionally, the voltage maintained on C1 ensures charge is drawn from the piezo beam only when its voltage exceeds C1's voltage by one diode drop, which occurs only when the beam approaches its maximum deflection. Thus a limited amount of charge is drawn on each cycle of the piezo beam, timed to coincide with the maximum deflection of the beam. This combination of factors helps prevent excessive mechanical damping of the beam, allowing usable output voltages to be output at lower vibration amplitudes while the piezo beam is driven near its mechanical resonance.

U2 provides a regulated output voltage determined by the ratio of R7 and R8. The power output per G of vibration will remain relatively constant across G-levels and loads, provided the load is capable of drawing at

least as much power as is being supplied (Figure 5). The converter duty cycle is approximated by the ratio of input power (G-level) vs. output power (voltage * current * time), less any small conversion losses and leakage. When the input power exceeds the output and losses, duty cycle will be 100%, and excess voltage at C1 is safely disposed of through D5.

R6 sets the peak current through inductor L1, and can be specified according to the equation:

$$R_{SENSE} = \left(\frac{0.067}{I_{MAX}} \right) - 0.25$$

where I_{MAX} is the maximum desired output current to the load. Generally, the peak inductor current should be set to maximum to improve efficiency with smaller (<300uH) inductors in space-limited applications; refer to the LT1474 datasheet for more thoughtful trade-offs between peak current and inductor size. Battery-charging applications requiring a (pulsed) constant-current charge phase, or where both the charge circuit and the load are directly connected across the battery pack, may require a lower I_{PEAK} setting to reduce voltage ripple caused by the charge pulses.

APPLICATIONS INFORMATION - LOAD ISOLATION EXAMPLE

Considerations for Conversion Efficiency

Converter efficiency is defined as the output power divided by the input power times 100%.

The losses from the circuit's front-end components (leakage across the storage capacitor, comparator, and R1-R3) will be small (μA) and largely proportional to the C1 voltage setpoint. Minimizing losses here is straightforward by appropriate component selection of C1 and suitably large values of R1 – R3. These small losses will occur for the entire time that voltage is present on C1.

The remaining controllable losses will occur in the step-down converter section and, apart from the LT1474's shutdown current, occur only during the ON-time of the output. The main losses will come from three sources: V_{IN} current, I^2R losses, and catch diode losses.

V_{IN}

The V_{IN} current of the LT1474 is due to two components: the DC bias current and the gate charge current of its internal P-channel switch. Both are proportional to V_{IN} ; however, at load currents $> 1\text{mA}$, the DC bias current (from $9\mu\text{A}$ at no load to $100\mu\text{A}$ in continuous mode) is negligible compared to the gate charge losses. Each time the gate is switched on and off, a packet of charge dQ moves from V_{IN} to ground. In continuous mode, $I_{GATE} = fQ_p$ where Q_p is the gate charge of the internal switch and f is the switching frequency. Since V_{IN} is pre-set according to piezo efficiency considerations, the best way to minimize this loss is to keep the output duty cycle low.

Resistive (I^2R) Losses

The resistances in the current path (The ON-resistance

of the internal switch, current sense resistor, and inductor) contribute resistive losses. At low values of V_{IN} , switch losses will dominate, and can be minimized by using a suitably large inductor and low I_{PEAK} . At higher supply voltages, these losses are proportional to load.

Catch Diode Losses

The catch diode, D7, introduces a loss ($V \cdot I$) as it conducts during the switch off-time, proportional to its forward voltage, and more pronounced at high supply voltage where the switch on-time is shorter. Again, V_{IN} is fixed for piezo efficiency reasons, so this loss is best minimized by minimizing the diode V_f and converter duty cycle. By lowering the duty cycle, a reduction in V_f of the catch diode will improve efficiency even though low- V_f diodes tend to have much higher reverse leakage currents, which will produce loss during the switch ON-time. In any event, the catch diode must be sized to safely handle I_{PEAK} at nearly 100% duty cycle (worst-case condition; output shorted).

The selection of $100\mu\text{H}$ inductor should be considered a minimum, for use in conjunction with high I_{PEAK} values. Particularly in applications where space is not constrained or I_{PEAK} must be reduced, inductors as large as $1000\mu\text{H}$ may be required for maximum efficiency. The ideal range of inductor size at a given I_{MAX} is a trade-off between the increased resistance of higher-value inductors and the increased switching rates required for lower-value inductors.

At light loads, the output duty cycle will rise and losses in the conversion stage (leakage, switching and catch diode losses) will accrue. This may or may not be a problem; it could simply mean that more power is available than the load can use.

APPLICATIONS INFORMATION - LOAD ISOLATION EXAMPLE

Application Example

The steps to configure this circuit optimally for a given load are presented below. This example assumes the following are known:

- Required output voltage
- Required output current
- Nominal piezo open-circuit voltage

1) Set output voltage

The output voltage is determined by

$$V_{out} = 1.23 \left(1 + \frac{R7}{R8} \right) - V_f$$

Where V_f is the forward voltage drop of D8 under load. In direct sensor-power applications where reverse leakage into the circuit during its off-time is not a concern, D8 may be omitted (but see important warnings below). To minimize no-load supply current, resistor values in the megaohm range should be used.

2) Choose inductor size and maximum inductor current, following the guidelines of the LT1474 datasheet. For greatest efficiency where space is not a concern, first choose the inductor current sense resistor R6 according to desired output current (R_{SENSE} Equation above), then size the inductor accordingly. For space-limited applications, size L1 as dictated by the available space and set I_{PEAK} as high as the inductor will tolerate without saturating.

3) Choose C1 bias voltage to be approximately $\frac{1}{2}$ the open-circuit piezo voltage in its natural vibration environment. In applications with highly variable amplitudes, a trade-off must be made between efficiency at higher amplitudes and the ability to harvest power from lower amplitudes: no charge will be drawn by this circuit if the piezo open-circuit voltage after rectification never reaches the set turn-on voltage.

(Circuit adaptations for self-adjusting bias voltage may be explored if the power gains exceed the consumption of the added circuitry.)

The LTC1540 features a programmable hysteresis band of up to 100mV. However, a larger hysteresis is generally preferable to allow for smaller values of C1 and/or longer output ON-times, particularly for directly-powered sensors. This can be accomplished by bypassing the onboard hysteresis adjustment ($R4=0$ ohms; $R5=open$) and adding a small amount of positive feedback via R3.

First select the desired center voltage (V_c) for C1 and the desired hysteresis band (V_{hb}). Choose a value for R1 such that the current across it at the trip point is substantially greater than the comparator's input leakage (1nA typ.), for example 100nA. The 5.7M value shown is perfectly reasonable, but the following will more formally dictate its upper limit. The LTC1540's internal reference (V_{ref}) is 1.182V. The current through R1 at the lower trip point is $(V_c - (V_{hb}/2) - V_{ref}) / R1$. Thus the upper limit for R1 is

$$R1 = \frac{V_c - \left(\frac{V_{hb}}{2} \right) - 1.182}{I_{R1}}$$

Choose R2 to set the center voltage, V_c . Neglecting the small influence of R3,

$$R2 = \frac{1.182 \cdot R1}{V_c - 1.182}$$

Choose R3 to set the hysteresis. At the lower comparator trip point, the threshold voltage will be equal to

$$V_L \cdot \frac{R2}{R2 + (R1 \parallel R3)}$$

APPLICATIONS INFORMATION - LOAD ISOLATION EXAMPLE

as the comparator will be ON when approaching this point. Solving for R3,

$$R3 = \frac{R1 \cdot R2 \cdot (VL - V_{th})}{R1 \cdot V_{th} + R2 \cdot V_{th} - R2 \cdot VL}$$

The addition of R3 will slightly affect the actual center voltage; however, this change will typically not be significant in comparison with the size of the hysteresis band. For a typical $V_C (> 3.3V)$, the final value of V_C will be lowered. As indicated by Figure 5, however, driving the piezo to moderately higher open-circuit voltages than optimal does not have an excessive impact on efficiency.

Check: Actual V_h and V_l

Once all resistor values are chosen, the actual upper and lower trip points will be defined by:

$$V_h = 1.182 \frac{(R2 \parallel R3) + R1}{(R2 \parallel R3)}$$

$$V_l = 1.182 \frac{(R1 \parallel R3) + R2}{R2}$$

Latch-Up Consideration

If diode D8 is removed, the designer must pay attention to D6, which is necessary to prevent latch-up of the LT1474's output switch if the voltage at its SW pin is held up while V_{IN} drops. This situation may easily occur in an application where the load is powered by multiple sources or includes a storage element, such as supercapacitor or battery, whose voltage drops more slowly than that of C1 when no harvested power is available. The user must then choose D6 so that the voltage at SW cannot exceed the voltage at V_{IN} by the 0.6V required for latch-up. Particularly at high C1 voltages, the designer must also take steps to ensure that reverse leakage over D6 will not allow the voltages at the V_{FB} and SW pins to float above their maximum ratings at no load.

APPLICATIONS INFORMATION - POWER MANAGEMENT IC INTEGRATION

Integration with LTC3588 Charge Management IC

The LTC3588-1 is an ultra low quiescent current power supply designed specifically for energy harvesting applications. The part is designed to interface directly to a piezoelectric or alternative A/C power source such as the Vulture™. The part rectifies a voltage waveform and stores harvested energy on an external capacitor, bleeds off any excess power via an internal shunt regulator, and maintains a regulated output voltage by means of a nanopower high efficiency synchronous buck regulator. When combined with a Vulture™ energy harvester the LTC3588-1 forms the base of a full energy harvesting solution.

The LTC3588-1 will gather energy and convert it to a useable output voltage to power any type of electronic system. Some applications may require much more peak power than a typical piezo can produce. The LTC3588-1 accumulates energy over a long period of time to enable efficient use for short power bursts. The frequency of bursts allowed is directly proportional to the power coming in from the piezo, and the total energy per burst. The LTC3588-1 allows for four different pin selectable output voltages (1.8, 2.5, 3.3 and 3.6).

PGOOD Signal

The PGOOD Signal is a logical high when V_{OUT} reaches 92% of the target value. This behavior is ideal for an enable or interrupt pin on a microprocessor. That way, the microprocessor can be idle until there is enough energy to supply the burst.

Capacitor Selection

The input and output capacitors should be selected based on the energy needs and load requirements of the application. The V_{IN} capacitor is placed between V_{IN} and GND. It should be rated to withstand the highest voltage that the piezo can put out. For 100mA or smaller loads, storing energy at the input takes

advantage of the high voltage input since the buck converter on the chip can deliver 100mA average current efficiently to the load. The input capacitor should then be sized to store enough energy to provide output power for the length of time required, while also not dropping to the undervoltage lockout falling threshold (UVLO falling). This threshold is approximately 300mV above the selected regulated output. The following simple equation shows energy out on the left-hand side, and effective energy in on the right-hand side.

$$P_{LOAD} t_{LOAD} = \frac{1}{2} \eta C_{IN} \left(V_{IN}^2 - V_{UVLOFALLING}^2 \right)$$

and

$$V_{UVLOFALLING} \leq V_{IN} \leq V_{SHUNT}$$

Where η is the efficiency of the buck converter, and V_{SHUNT} is the voltage at which the input shunt regulator bleeds power from the input (typically 20V). See LTC3588 datasheet for more detail on η , as it depends on the selected regulated output, the value of the inductor, the load current, and temperature. Keeping C_{IN} at this value or greater ensures that there is enough power stored at the input to perform each burst.

To size the output capacitor, the following equation is used:

$$t_{SLEEP} = C_{OUT} \frac{24mV}{I_{LOAD}}$$

For capacitor values on the order of 10uF, some non-ideal delays are introduced, resulting in V_{OUT} ripple. For smoother operation, it is recommended that C_{OUT} be kept higher than 10uF.

APPLICATIONS INFORMATION - POWER MANAGEMENT IC INTEGRATION

Inductor

The buck converter is optimized to work with an inductor in the range of 10uH to 100uH. 10uH is adequate for space-limited applications, but 100uH may provide greater efficiency, particularly as the ratio between input and output voltage increases (see LTC3588 datasheet). Choose an inductor with a DC current rating greater than 350mA. Lower DCR inductors can impact the efficiency of the buck converter.

V_{IN2} and CAP Capacitors

A 1uF capacitor should be connected between V_{IN} and CAP and a 4.7uF capacitor should be connected between V_{IN2} and GND. These capacitors hold up the internal rails during buck switching and compensate the internal rail generation circuits. In applications where the input source is limited, to less than 6V, the CAP pin can be tied to GND and the V_{IN2} pin can be tied to V_{IN}. In this scenario, a 5.6V Zener diode can be used to clamp V_{IN}.

