

MIRELLA-50-W

~40° wide beam

SPECIFICATION:

Dimensions	Ø 49.9 mm
Height	23.9 mm
Fastening	glue
ROHS compliant	yes ⓘ

MATERIALS:

Component	Type	Material	Colour	Finish	Coating
MIRELLA-50-W	Reflector	PC	metal		lacquer







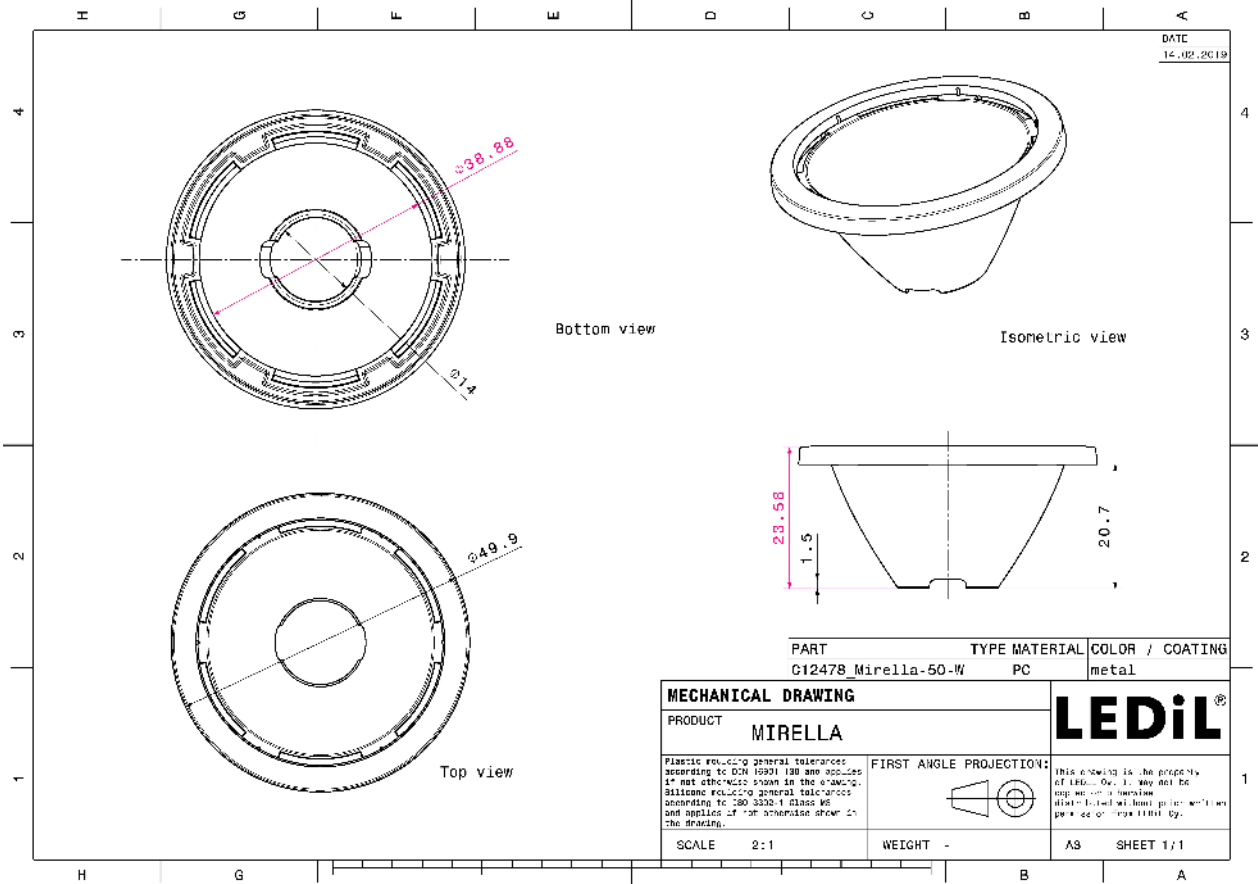

ORDERING INFORMATION:

Component	Qty in box	MOQ	MPQ	Box weight (kg)
C12478_MIRELLA-50-W » Box size: 480 x 280 x 300 mm	336	112	28	3.0

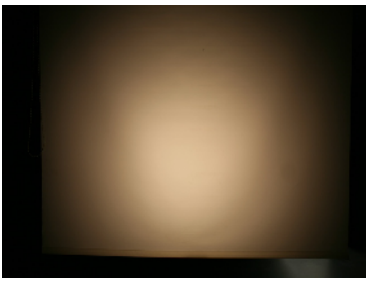
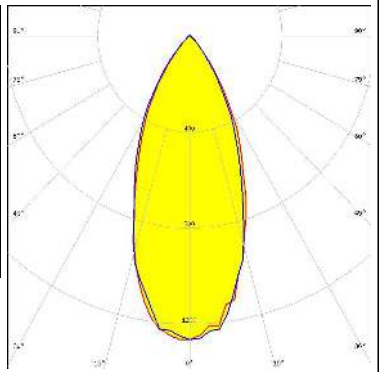

See also our general installation guide: www.ledil.com/installation_guide

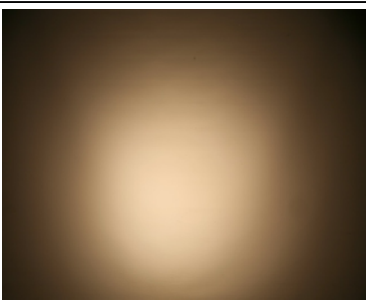
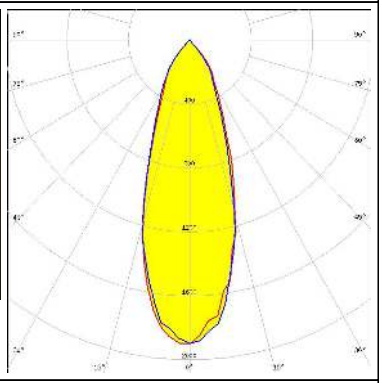
OPTICAL RESULTS (MEASURED):

<p></p> <p>LED BXRA LS FWHM / FWTM 43.0° / 78.0° Efficiency 82 % Peak intensity 1.3 cd/lm LEDs/each optic 1 Light colour White Required components: C12479_MIRELLA-DL</p>		
<p></p> <p>LED BXRA LS FWHM / FWTM 42.0° / 78.0° Efficiency 84 % Peak intensity 1.4 cd/lm LEDs/each optic 1 Light colour White Required components: C13333_MIRELLA-CL</p>		
<p></p> <p>LED BXRA LS FWHM / FWTM 35.0° / 78.0° Efficiency 88 % Peak intensity 1.9 cd/lm LEDs/each optic 1 Light colour White Required components:</p>		
<p>CITIZEN</p> <p>LED CLL01x FWHM / FWTM 48.0° / 80.0° Efficiency 84 % Peak intensity 1.2 cd/lm LEDs/each optic 1 Light colour White Required components: C13333_MIRELLA-CL</p>		

OPTICAL RESULTS (MEASURED):

CITIZEN

LED CLL01x
 FWHM / FWTM 44.0° / 85.0°
 Efficiency %
 LEDs/each optic 1
 Light colour White
 Required components:

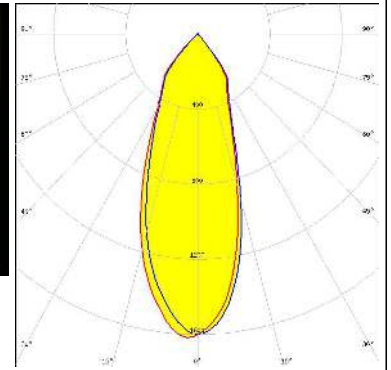

CITIZEN

LED CLL01x
 FWHM / FWTM 50.0° / 86.0°
 Efficiency %
 LEDs/each optic 1
 Light colour White
 Required components:
 C12479_MIRELLA-DL

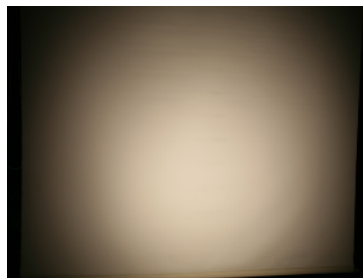

CITIZEN

LED CLL02x/CLU02x (LES10)
 FWHM / FWTM 48.0° / 82.0°
 Efficiency 82 %
 LEDs/each optic 1
 Light colour White
 Required components:
 C12479_MIRELLA-DL

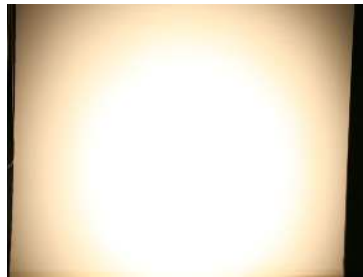

CITIZEN

LED CLL02x/CLU02x (LES10)
 FWHM / FWTM 50.0° / 84.0°
 Efficiency 83 %
 Peak intensity 1.1 cd/m
 LEDs/each optic 1
 Light colour White
 Required components:
 C12479_MIRELLA-DL

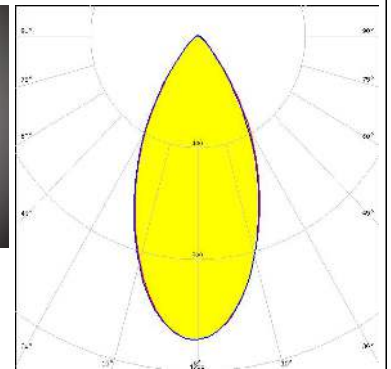
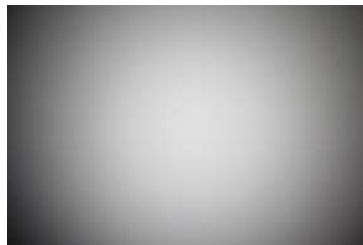

OPTICAL RESULTS (MEASURED):

CITIZEN

LED CLL02x/CLU02x (LES10)
FWHM / FWTM 50.0° / 87.0°
Efficiency 82 %
Peak intensity 1 cd/lm
LEDs/each optic 1
Light colour White
Required components:
C13723_MIRELLA-RZL

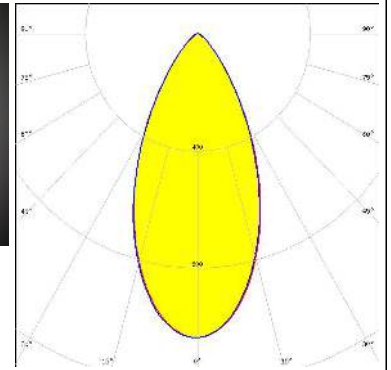
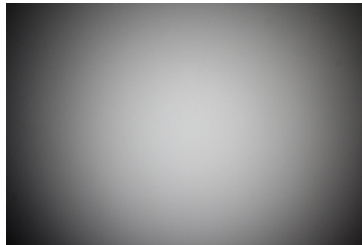

CITIZEN

LED CLL02x/CLU02x (LES10)
FWHM / FWTM 42.0° / 82.0°
Efficiency 90 %
LEDs/each optic 1
Light colour White
Required components:



CITIZEN

LED CLL02x/CLU02x (LES10)
FWHM / FWTM 46.0° / 78.0°
Efficiency 84 %
Peak intensity 1.2 cd/lm
LEDs/each optic 1
Light colour White
Required components:
C13333_MIRELLA-CL

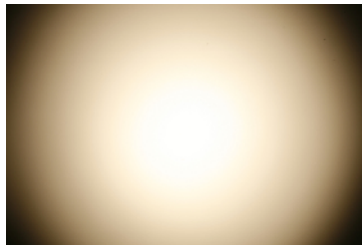

CITIZEN

LED CLU700/701/702/703
FWHM / FWTM 46.0° / 83.0°
Efficiency 80 %
Peak intensity 1.1 cd/lm
LEDs/each optic 1
Light colour White
Required components:
C13723_MIRELLA-RZL

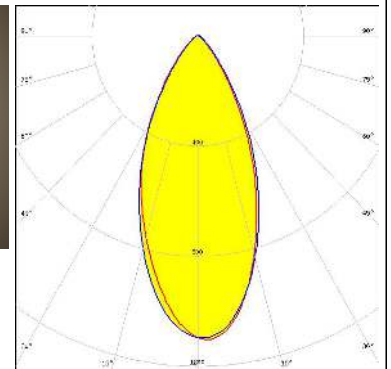

OPTICAL RESULTS (MEASURED):

CITIZEN

LED CLU700/701/702/703
 FWHM / FWTM 40.0° / 83.0°
 Efficiency 88 %
 Peak intensity 1.4 cd/lm
 LEDs/each optic 1
 Light colour White
 Required components:

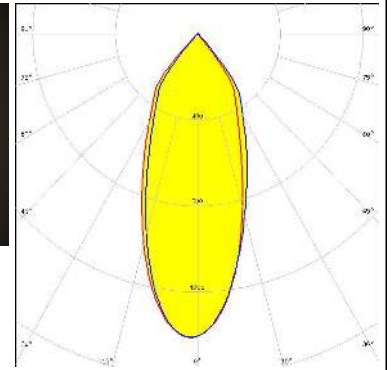
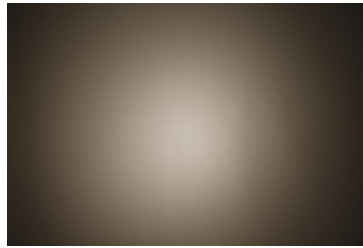

CITIZEN

LED CLU700/701/702/703
 FWHM / FWTM 47.0° / 81.0°
 Efficiency 82 %
 Peak intensity 1.1 cd/lm
 LEDs/each optic 1
 Light colour White
 Required components:
 C12479_MIRELLA-DL

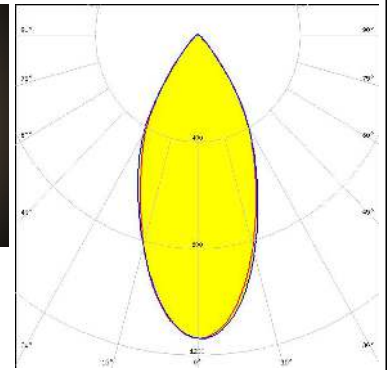
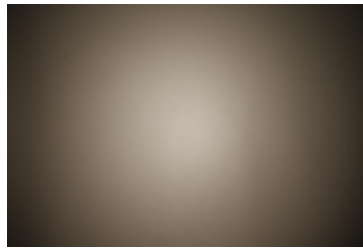

CITIZEN

LED CLU700/701/702/703
 FWHM / FWTM 44.0° / 77.0°
 Efficiency 82 %
 Peak intensity 1.3 cd/lm
 LEDs/each optic 1
 Light colour White
 Required components:
 C13333_MIRELLA-CL

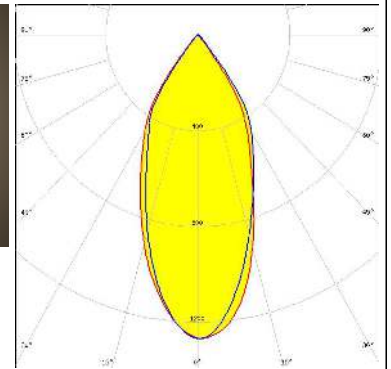
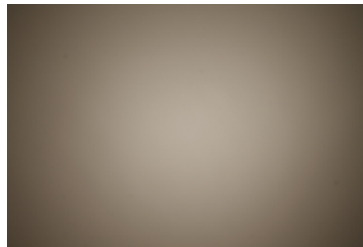

CITIZEN

LED CLU710/711
 FWHM / FWTM 50.0° / 85.0°
 Efficiency 79 %
 Peak intensity 1 cd/lm
 LEDs/each optic 1
 Light colour White
 Required components:
 C12479_MIRELLA-DL

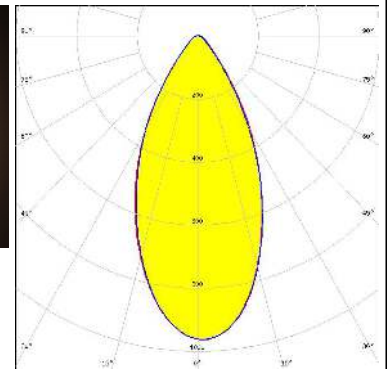
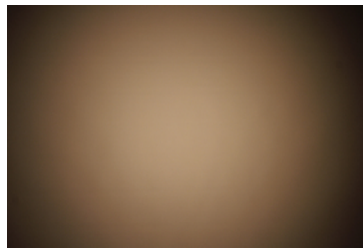

OPTICAL RESULTS (MEASURED):

CITIZEN

LED CLU710/711
 FWHM / FWTM 48.0° / 79.0°
 Efficiency 83 %
 Peak intensity 1.1 cd/lm
 LEDs/each optic 1
 Light colour White
 Required components:
 C13333_MIRELLA-CL

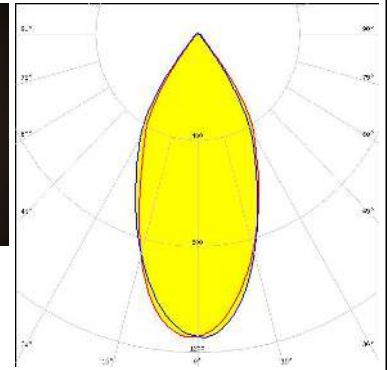
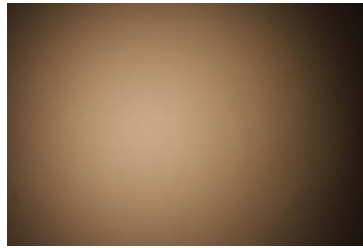

CITIZEN

LED CLU710/711
 FWHM / FWTM 46.0° / 84.0°
 Efficiency 88 %
 Peak intensity 1.2 cd/lm
 LEDs/each optic 1
 Light colour White
 Required components:

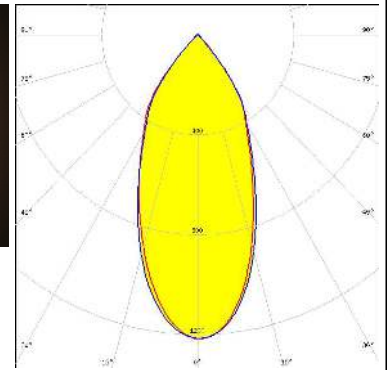
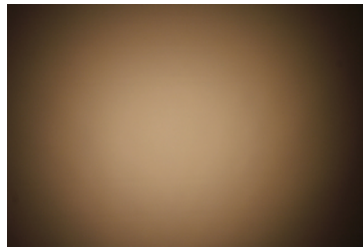

CITIZEN

LED CLU710/711
 FWHM / FWTM 49.0° / 87.0°
 Efficiency 80 %
 Peak intensity 1 cd/lm
 LEDs/each optic 1
 Light colour White
 Required components:
 C13723_MIRELLA-RZL

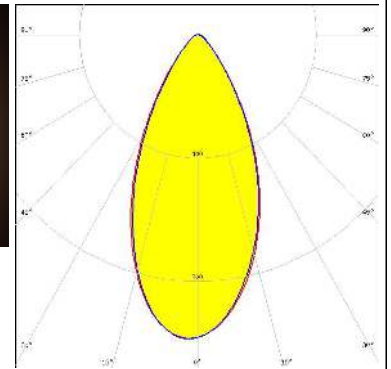
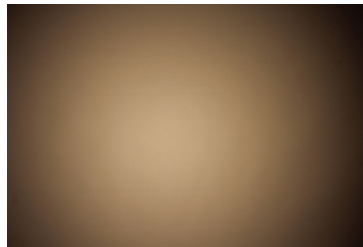

CITIZEN

LED CLU720/721/723
 FWHM / FWTM 53.0° / 88.0°
 Efficiency 79 %
 Peak intensity 0.9 cd/lm
 LEDs/each optic 1
 Light colour White
 Required components:
 C12479_MIRELLA-DL

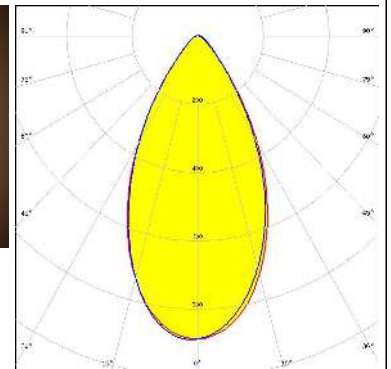
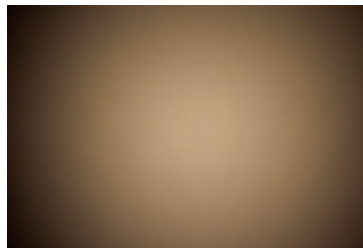

OPTICAL RESULTS (MEASURED):

CITIZEN

LED CLU720/721/723
 FWHM / FWTM 55.0° / 81.0°
 Efficiency 83 %
 Peak intensity 1 cd/lm
 LEDs/each optic 1
 Light colour White
 Required components:
 C13333_MIRELLA-CL

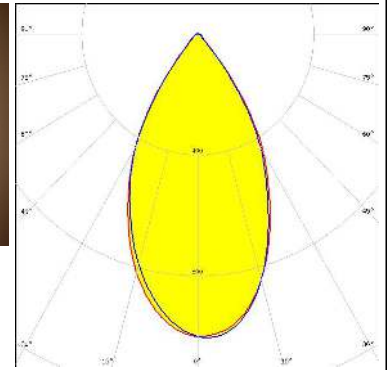
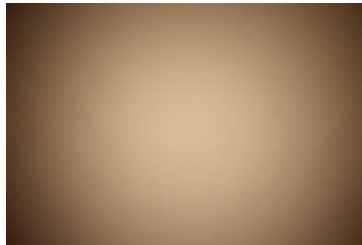

CITIZEN

LED CLU720/721/723
 FWHM / FWTM 53.0° / 90.0°
 Efficiency 80 %
 Peak intensity 0.9 cd/lm
 LEDs/each optic 1
 Light colour White
 Required components:
 C13723_MIRELLA-RZL

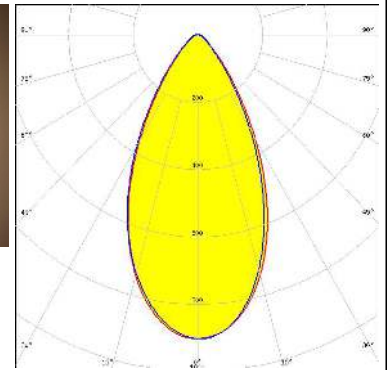
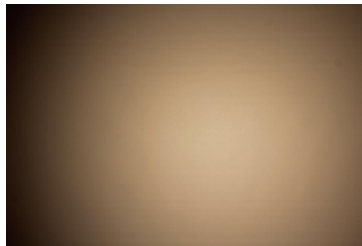

CITIZEN

LED CLU720/721/723
 FWHM / FWTM 51.0° / 85.0°
 Efficiency 88 %
 Peak intensity 1.1 cd/lm
 LEDs/each optic 1
 Light colour White
 Required components:

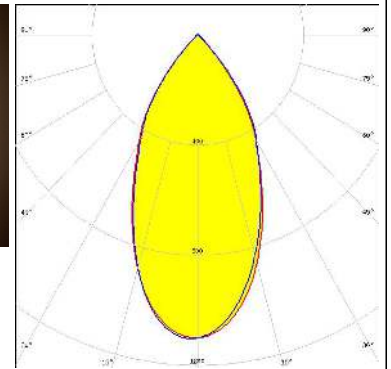
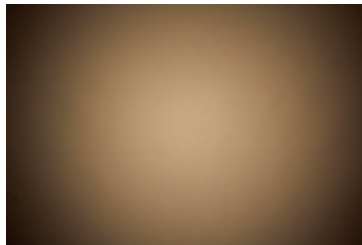

CREE LED

LED CXA/B 13xx
 FWHM / FWTM 37.0° / 80.0°
 Efficiency 86 %
 Peak intensity 1.8 cd/lm
 LEDs/each optic 1
 Light colour White
 Required components:

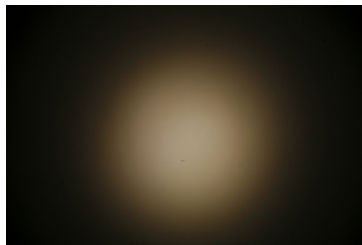

OPTICAL RESULTS (MEASURED):

CREE LED

LED CXA/B 13xx
 FWHM / FWTM 43.0° / 76.0°
 Efficiency 81 %
 Peak intensity 1.4 cd/lm
 LEDs/each optic 1
 Light colour White
 Required components:
 C12479_MIRELLA-DL



CREE LED

LED CXA/B 13xx
 FWHM / FWTM 42.0° / 76.0°
 Efficiency 81 %
 Peak intensity 1.5 cd/lm
 LEDs/each optic 1
 Light colour White
 Required components:
 C13333_MIRELLA-CL



CREE LED

LED CXA/B 15xx
 FWHM / FWTM 50.0° / 82.0°
 Efficiency 87 %
 Peak intensity 1.1 cd/lm
 LEDs/each optic 1
 Light colour White
 Required components:
 C12479_MIRELLA-DL

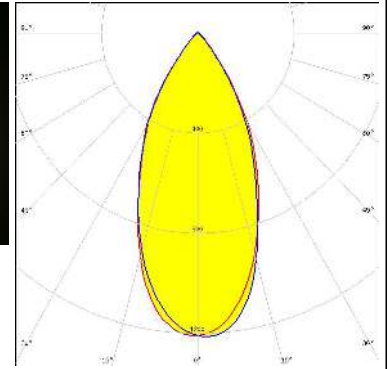
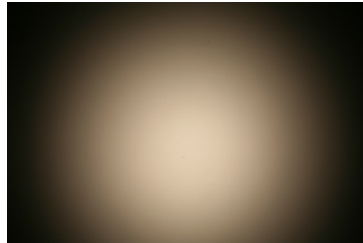

CREE LED



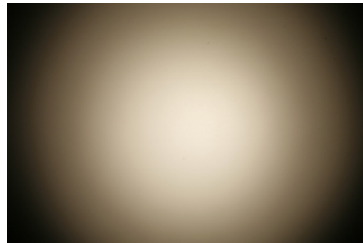

LED CXA/B 15xx
 FWHM / FWTM 46.0° / 79.0°
 Efficiency 85 %
 Peak intensity 1.4 cd/lm
 LEDs/each optic 1
 Light colour White
 Required components:
 C13333_MIRELLA-CL

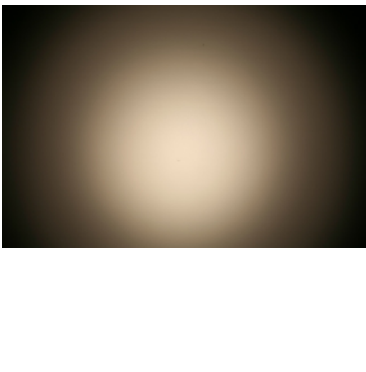
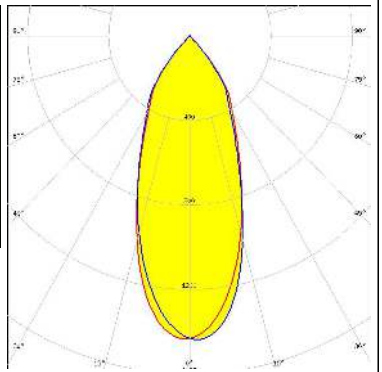
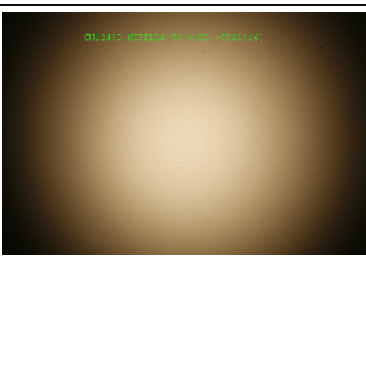
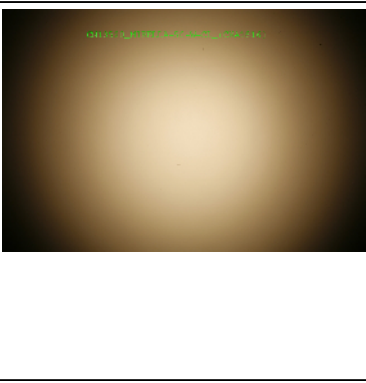
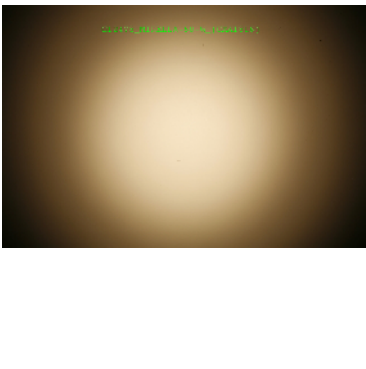



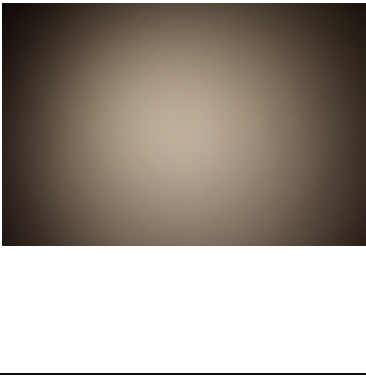
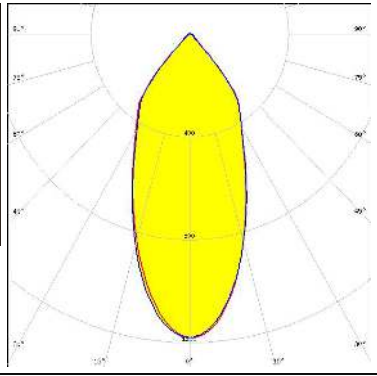
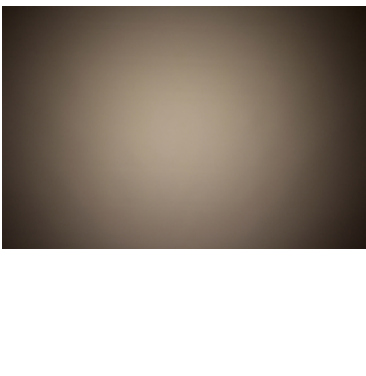
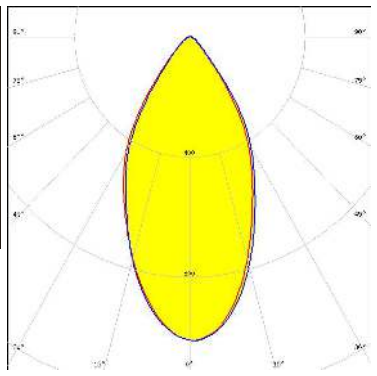

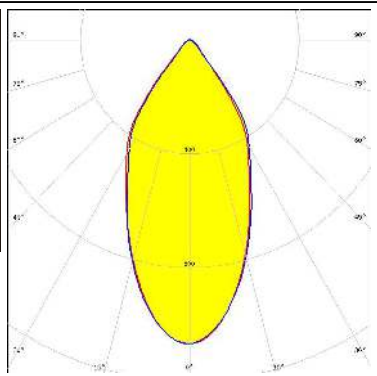

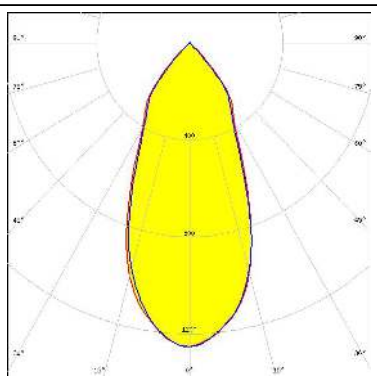
OPTICAL RESULTS (MEASURED):

<p>CREE ⇄ LED</p> <p>LED CXA/B 15xx FWHM / FWTM 42.0° / 84.0° Efficiency 91 % Peak intensity 1.4 cd/lm LEDs/each optic 1 Light colour White Required components:</p>		
<p>CREE ⇄ LED</p> <p>LED CXA/B 1816 & CXA/B 1820 & CXA 1850 FWHM / FWTM 52.0° / 84.0° Efficiency 82 % Peak intensity 1.2 cd/lm LEDs/each optic 1 Light colour White Required components: C12479_MIRELLA-DL</p>		
<p>CREE ⇄ LED</p> <p>LED CXA/B 1816 & CXA/B 1820 & CXA 1850 FWHM / FWTM 56.0° / 84.0° Efficiency 82 % Peak intensity 1.1 cd/lm LEDs/each optic 1 Light colour White Required components: C13333_MIRELLA-CL</p>		
<p>CREE ⇄ LED</p> <p>LED CXA/B 1816 & CXA/B 1820 & CXA 1850 FWHM / FWTM 52.0° / 88.0° Efficiency 87 % Peak intensity 1.2 cd/lm LEDs/each optic 1 Light colour White Required components:</p>		

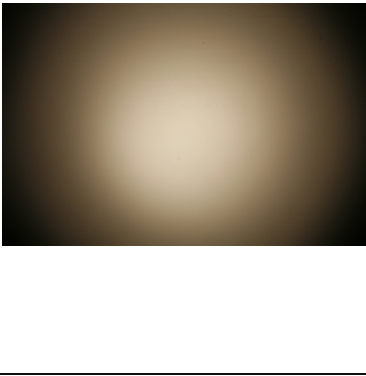
OPTICAL RESULTS (MEASURED):

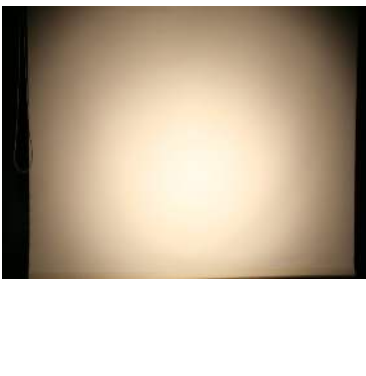
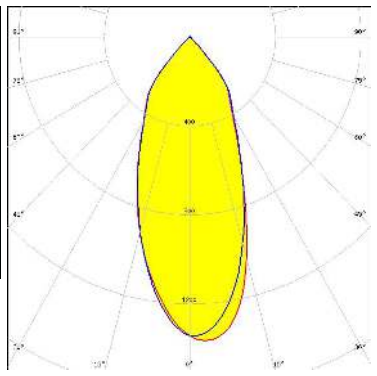
<p>CREE ⇄ LED</p> <p>LED MHD-E/G FWHM / FWTM 46.0° / 88.0° Efficiency 92 % Peak intensity 1.2 cd/lm LEDs/each optic 1 Light colour White Required components:</p>		
<p>CREE ⇄ LED</p> <p>LED MHD-E/G FWHM / FWTM 52.0° / 87.0° Efficiency 87 % Peak intensity 1 cd/lm LEDs/each optic 1 Light colour White Required components: C12479_MIRELLA-DL</p>		
<p>CREE ⇄ LED</p> <p>LED MHD-E/G FWHM / FWTM 50.0° / 83.0° Efficiency 87 % Peak intensity 1.1 cd/lm LEDs/each optic 1 Light colour White Required components: C13333_MIRELLA-CL</p>		
<p>CREE ⇄ LED</p> <p>LED MT-G FWHM / FWTM 46.0° / 86.0° Efficiency 90 % Peak intensity 1.3 cd/lm LEDs/each optic 1 Light colour White Required components:</p>		

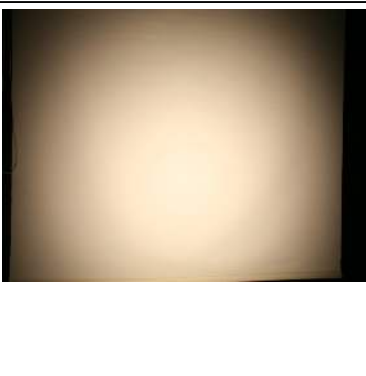
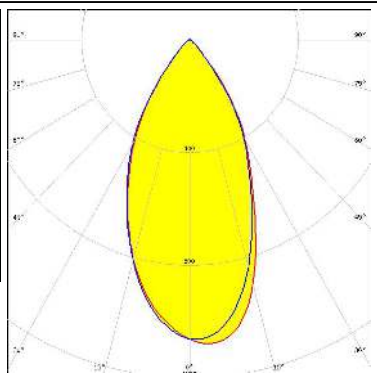

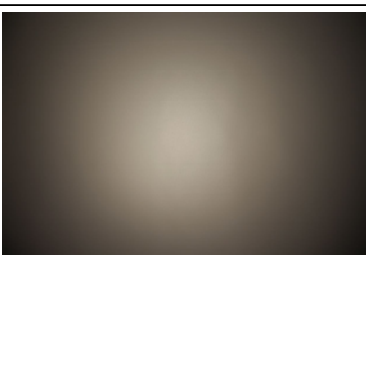
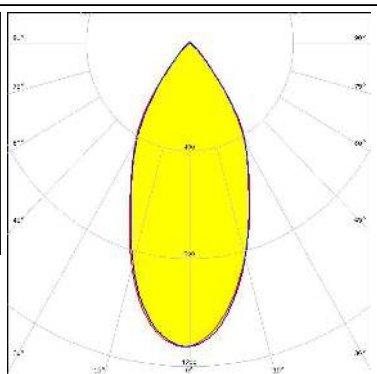
OPTICAL RESULTS (MEASURED):

<p>CREE  LED</p> <p>LED MT-G2 FWHM / FWTM 50.0° / 82.0° Efficiency 84 % Peak intensity 1.1 cd/m LEDs/each optic 1 Light colour White Required components: C13333_MIRELLA-CL</p>		
<p>CREE  LED</p> <p>LED MT-G2 FWHM / FWTM 46.0° / 86.0° Efficiency 91 % Peak intensity 1.4 cd/m LEDs/each optic 1 Light colour White Required components:</p>		
<p>CREE  LED</p> <p>LED MT-G2 FWHM / FWTM 52.0° / 87.0° Efficiency 83 % Peak intensity 1.1 cd/m LEDs/each optic 1 Light colour White Required components: C12479_MIRELLA-DL</p>		
<p>CREE  LED</p> <p>LED XHP50 FWHM / FWTM 48.0° / 82.0° Efficiency 85 % Peak intensity 1.1 cd/m LEDs/each optic 1 Light colour White Required components: C12479_MIRELLA-DL</p>		

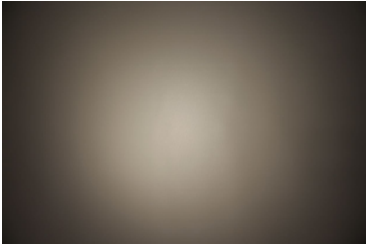
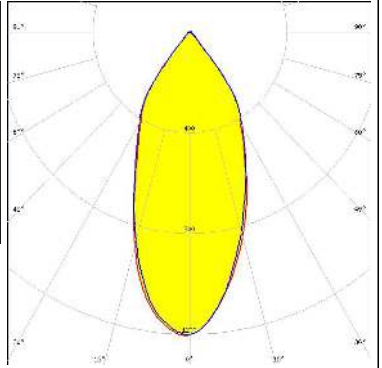
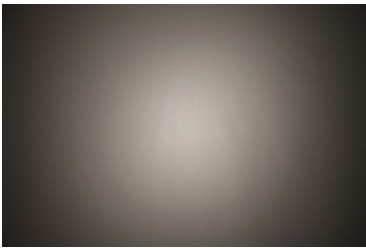
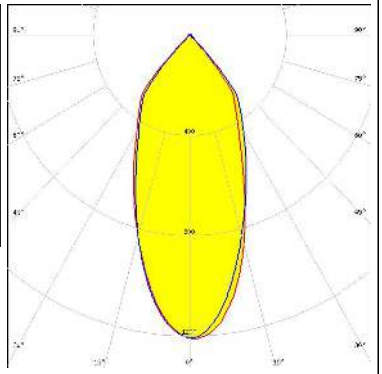
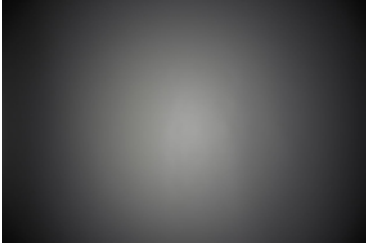
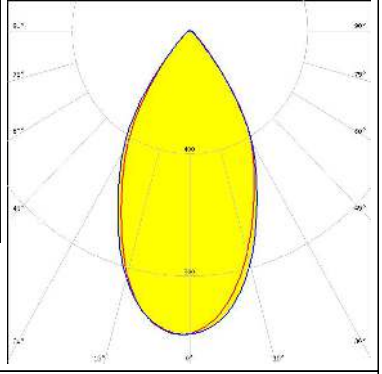
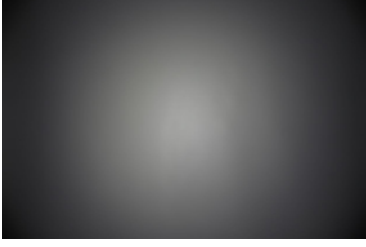
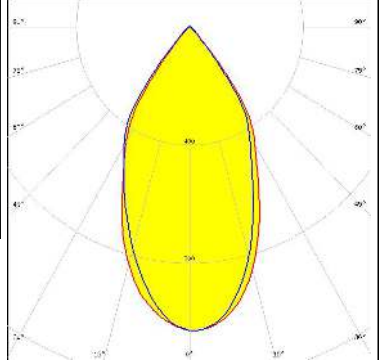

OPTICAL RESULTS (MEASURED):

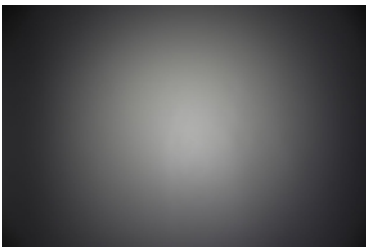
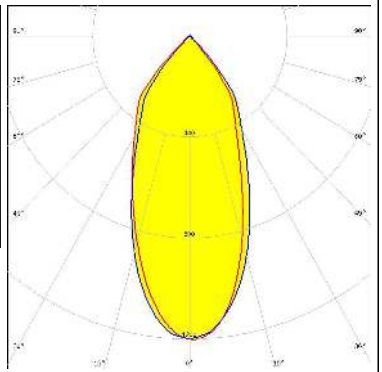
<p>CREE ⇄ LED</p> <p>LED XHP50 FWHM / FWTM 45.0° / 80.0° Efficiency 84 % Peak intensity 1.2 cd/lm LEDs/each optic 1 Light colour White Required components: C13333_MIRELLA-CL</p>		
<p>CREE ⇄ LED</p> <p>LED XHP50 FWHM / FWTM 45.0° / 87.0° Efficiency 89 % Peak intensity 1.2 cd/lm LEDs/each optic 1 Light colour White Required components:</p>		
<p>CREE ⇄ LED</p> <p>LED XHP70 FWHM / FWTM 54.0° / 85.0° Efficiency 84 % Peak intensity 1 cd/lm LEDs/each optic 1 Light colour White Required components: C12479_MIRELLA-DL</p>		
<p>CREE ⇄ LED</p> <p>LED XHP70 FWHM / FWTM 53.0° / 83.0° Efficiency 84 % Peak intensity 1 cd/lm LEDs/each optic 1 Light colour White Required components: C13333_MIRELLA-CL</p>		

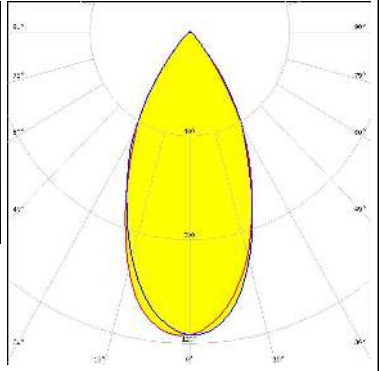
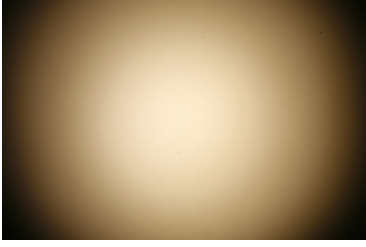
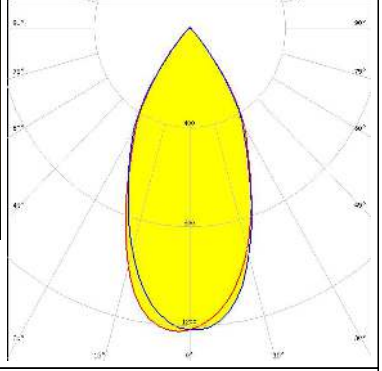
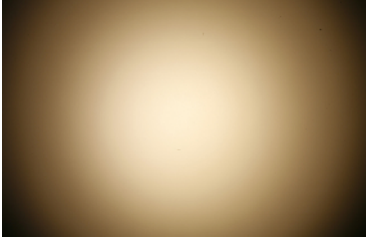
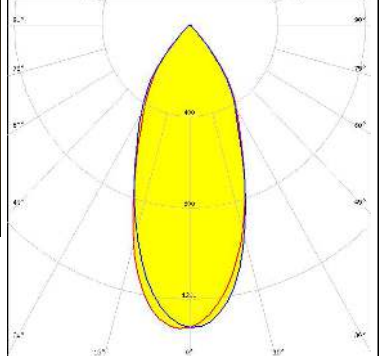



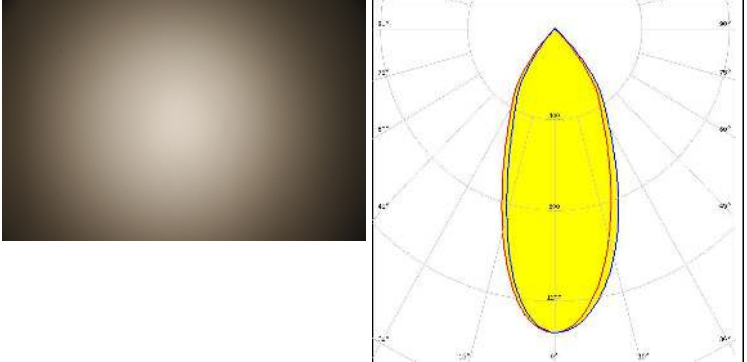

OPTICAL RESULTS (MEASURED):

<p>CREE LED</p> <p>LED XHP70 FWHM / FWTM 45.0° / 87.0° Efficiency 89 % Peak intensity 1.2 cd/lm LEDs/each optic 1 Light colour White Required components:</p>		
<p>LUMILEDS</p> <p>LED LUXEON CoB 1202/1203 FWHM / FWTM 50.0° / 81.0° Efficiency 84 % Peak intensity 1.2 cd/lm LEDs/each optic 1 Light colour White Required components: C12479_MIRELLA-DL</p>		
<p>LUMILEDS</p> <p>LED LUXEON CoB 1202/1203 FWHM / FWTM 49.0° / 80.0° Efficiency 84 % Peak intensity 1.2 cd/lm LEDs/each optic 1 Light colour White Required components: C13333_MIRELLA-CL</p>		
<p>LUMILEDS</p> <p>LED LUXEON CoB 1202/1203 FWHM / FWTM 44.0° / 84.0° Efficiency 87 % Peak intensity 1.3 cd/lm LEDs/each optic 1 Light colour White Required components:</p>		

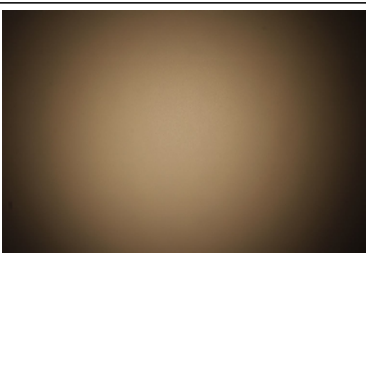
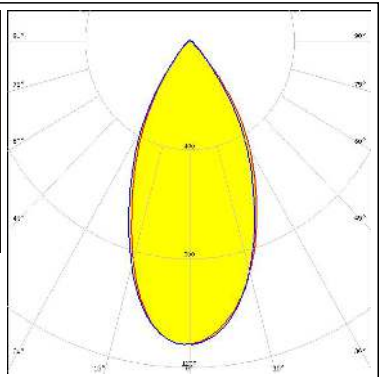

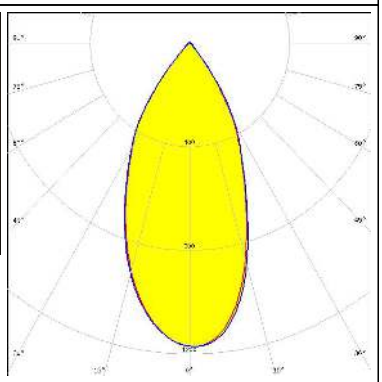

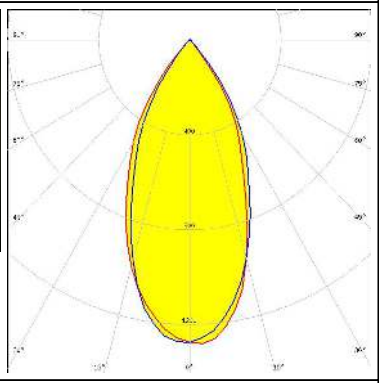

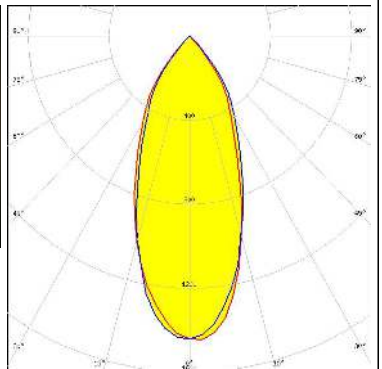
OPTICAL RESULTS (MEASURED):

<p>LUMILEDS</p> <p>LED LUXEON S1000 FWHM / FWTM 34.0° / 79.0° Efficiency % LEDs/each optic 1 Light colour White Required components:</p>	
<p>LUMILEDS</p> <p>LED LUXEON S1000 FWHM / FWTM 41.0° / 79.0° Efficiency % LEDs/each optic 1 Light colour White Required components: C12479_MIRELLA-DL</p>	
<p>LUMILEDS</p> <p>LED LUXEON S1000 FWHM / FWTM 34.0° / 75.0° Efficiency 84 % Peak intensity 1.7 cd/lm LEDs/each optic 1 Light colour White Required components: C13333_MIRELLA-CL</p>	
<p>LUMINUS</p> <p>LED CxM-9 (13.5x13.5) FWHM / FWTM 43.0° / 83.0° Efficiency 89 % Peak intensity 1.3 cd/lm LEDs/each optic 1 Light colour White Required components:</p>	

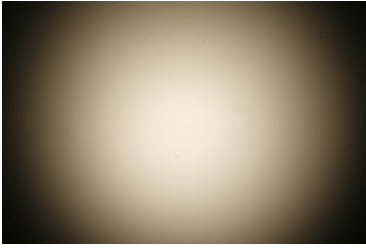
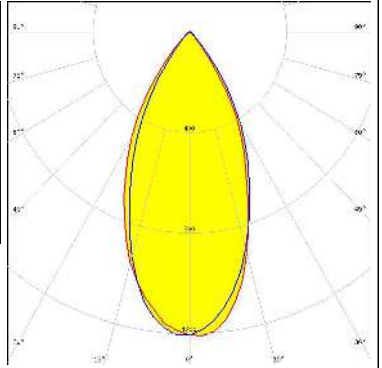

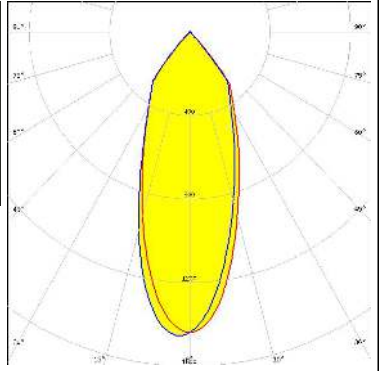
OPTICAL RESULTS (MEASURED):

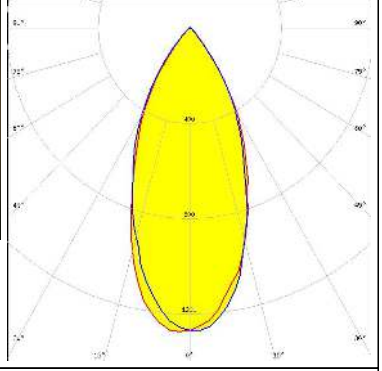
<p>LUMINUS</p> <p>LED CxM-9 (13.5x13.5)</p> <p>FWHM / FWTM 49.0° / 81.0°</p> <p>Efficiency 83 %</p> <p>Peak intensity 1.1 cd/lm</p> <p>LEDs/each optic 1</p> <p>Light colour White</p> <p>Required components: C12479_MIRELLA-DL</p>		
<p>LUMINUS</p> <p>LED CxM-9 (13.5x13.5)</p> <p>FWHM / FWTM 48.0° / 79.0°</p> <p>Efficiency 83 %</p> <p>Peak intensity 1.2 cd/lm</p> <p>LEDs/each optic 1</p> <p>Light colour White</p> <p>Required components: C13333_MIRELLA-CL</p>		
<p>NICHIA</p> <p>LED COB L-Type (LES 9)</p> <p>FWHM / FWTM 47.0° / 79.0°</p> <p>Efficiency 85 %</p> <p>Peak intensity 1.3 cd/lm</p> <p>LEDs/each optic 1</p> <p>Light colour White</p> <p>Required components: C13333_MIRELLA-CL</p>		
<p>NICHIA</p> <p>LED COB L-Type (LES 9)</p> <p>FWHM / FWTM 42.0° / 82.0°</p> <p>Efficiency 89 %</p> <p>Peak intensity 1.4 cd/lm</p> <p>LEDs/each optic 1</p> <p>Light colour White</p> <p>Required components:</p>		

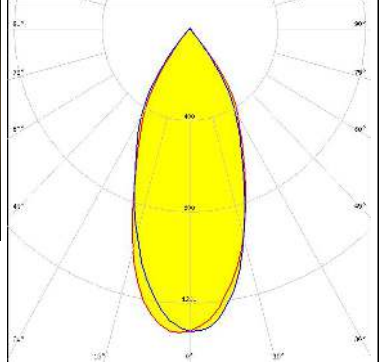
OPTICAL RESULTS (MEASURED):

<p>NICHIA</p> <p>LED COB L-Type (LES 9)</p> <p>FWHM / FWTM 48.0° / 80.0°</p> <p>Efficiency 83 %</p> <p>Peak intensity 1.2 cd/lm</p> <p>LEDs/each optic 1</p> <p>Light colour White</p> <p>Required components: C12479_MIRELLA-DL</p>		
<p>NICHIA</p> <p>LED NFMW48xA</p> <p>FWHM / FWTM 38.0° / 83.0°</p> <p>Efficiency 88 %</p> <p>Peak intensity 1.5 cd/lm</p> <p>LEDs/each optic 1</p> <p>Light colour White</p> <p>Required components:</p>		
<p>NICHIA</p> <p>LED NSCxL036A</p> <p>FWHM / FWTM 46.0° / 80.0°</p> <p>Efficiency 83 %</p> <p>Peak intensity 1.3 cd/lm</p> <p>LEDs/each optic 1</p> <p>Light colour White</p> <p>Required components: C12479_MIRELLA-DL</p>		
<p>NICHIA</p> <p>LED NSCxL036A</p> <p>FWHM / FWTM 44.0° / 78.0°</p> <p>Efficiency 83 %</p> <p>Peak intensity 1.3 cd/lm</p> <p>LEDs/each optic 1</p> <p>Light colour White</p> <p>Required components: C13333_MIRELLA-CL</p>		

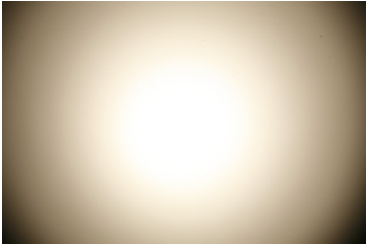
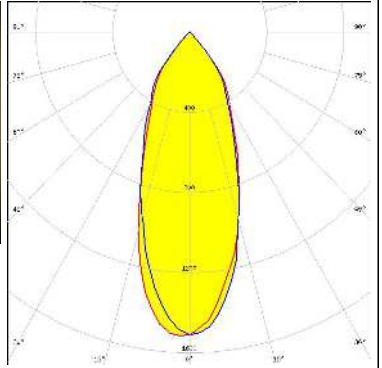

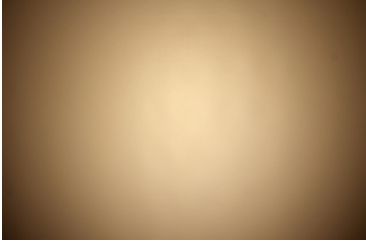
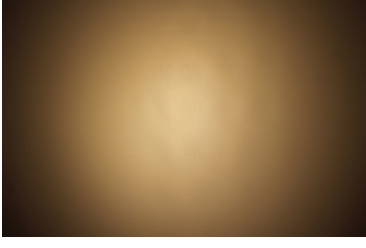

OPTICAL RESULTS (MEASURED):

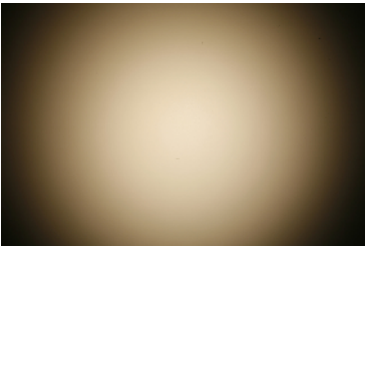
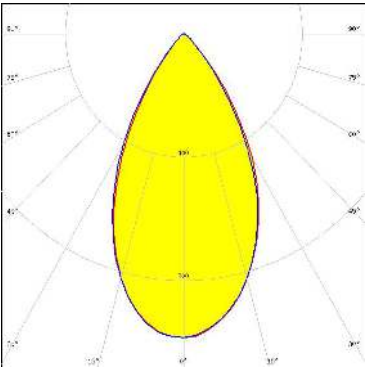
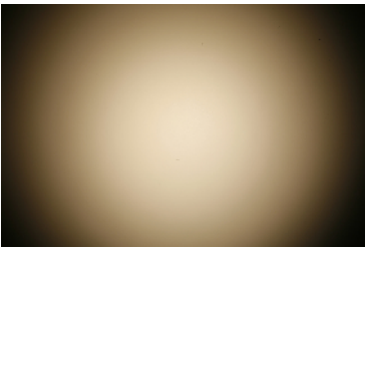
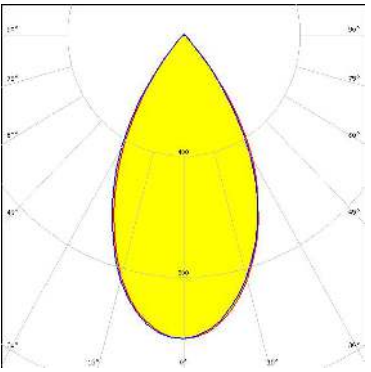
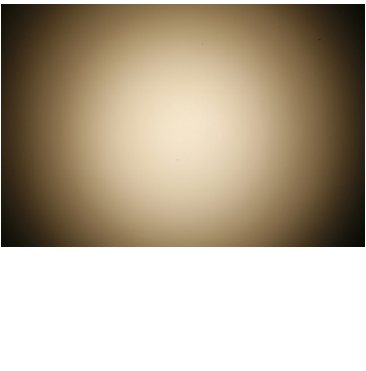
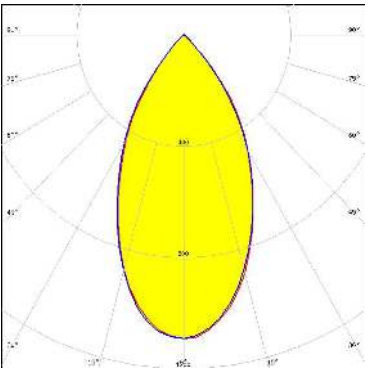
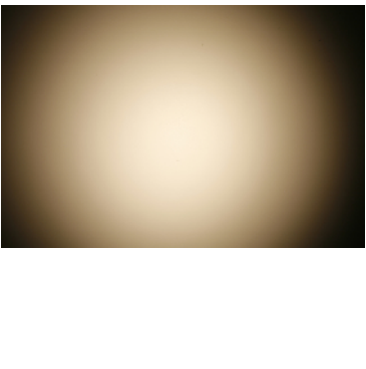
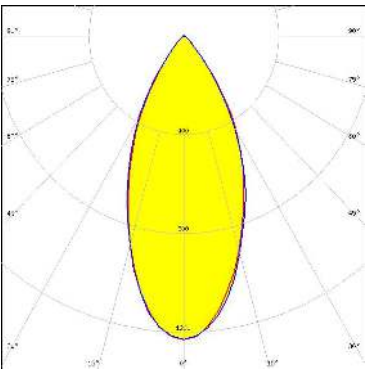
<p>NICHIA</p> <p>LED NSCxL036A FWHM / FWTM 40.0° / 82.0° Efficiency 87 % Peak intensity 1.5 cd/lm LEDs/each optic 1 Light colour White Required components:</p>		
<p>OSRAM Opto Semiconductors</p> <p>LED Duris S10 FWHM / FWTM 40.0° / 84.0° Efficiency 87 % Peak intensity 1.5 cd/lm LEDs/each optic 1 Light colour White Required components:</p>		
<p>OSRAM Opto Semiconductors</p> <p>LED Duris S10 FWHM / FWTM 49.0° / 86.0° Efficiency 79 % Peak intensity 1.1 cd/lm LEDs/each optic 1 Light colour White Required components: C12479_MIRELLA-DL</p>		
<p>OSRAM Opto Semiconductors</p> <p>LED Duris S10 FWHM / FWTM 45.0° / 79.0° Efficiency 82 % Peak intensity 1.3 cd/lm LEDs/each optic 1 Light colour White Required components: C13333_MIRELLA-CL</p>		

OPTICAL RESULTS (MEASURED):

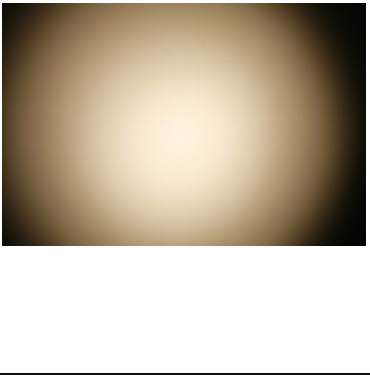
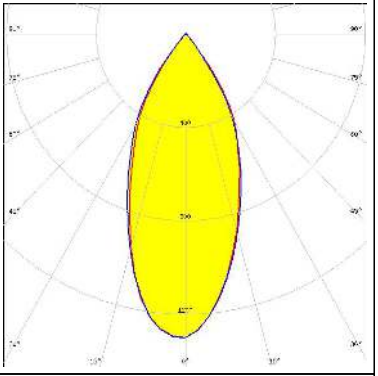
<p>OSRAM Opto Semiconductors</p> <p>LED Soleriq S13</p> <p>FWHM / FWTM 57.0° / 85.0°</p> <p>Efficiency 81 %</p> <p>Peak intensity 1 cd/lm</p> <p>LEDs/each optic 1</p> <p>Light colour White</p> <p>Required components: C12479_MIRELLA-DL</p>		
<p>OSRAM Opto Semiconductors</p> <p>LED Soleriq S13</p> <p>FWHM / FWTM 57.0° / 83.0°</p> <p>Efficiency 80 %</p> <p>Peak intensity 1 cd/lm</p> <p>LEDs/each optic 1</p> <p>Light colour White</p> <p>Required components: C13333_MIRELLA-CL</p>		
<p>OSRAM Opto Semiconductors</p> <p>LED Soleriq S13</p> <p>FWHM / FWTM 55.0° / 86.0°</p> <p>Efficiency 85 %</p> <p>LEDs/each optic 1</p> <p>Light colour White</p> <p>Required components:</p>		
<p>SECOIL SEMICONDUCTOR</p> <p>LED ZC4/6</p> <p>FWHM / FWTM 48.0° / 80.0°</p> <p>Efficiency 81 %</p> <p>Peak intensity 1.2 cd/lm</p> <p>LEDs/each optic 1</p> <p>Light colour White</p> <p>Required components: C12479_MIRELLA-DL</p>		

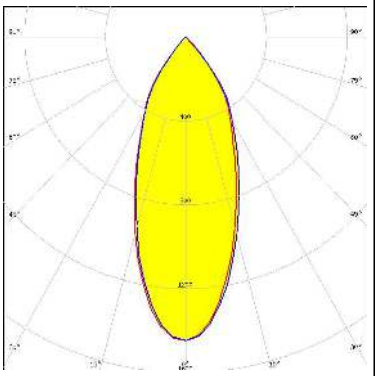
OPTICAL RESULTS (MEASURED):

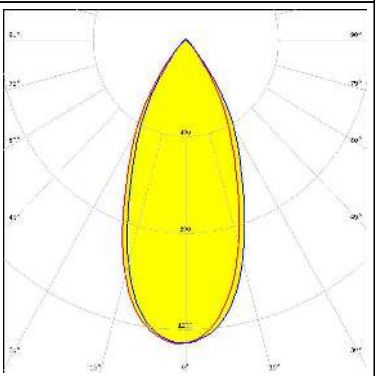
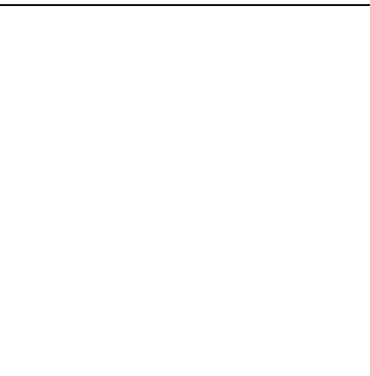
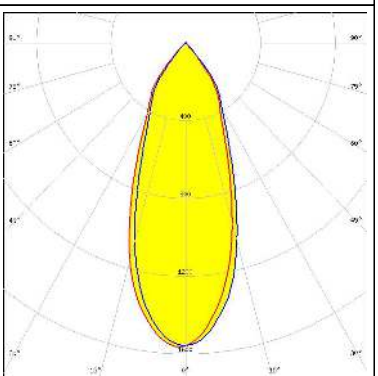
<p> SEOUL SEMICONDUCTOR</p> <p>LED ZC4/6</p> <p>FWHM / FWTM 46.0° / 78.0°</p> <p>Efficiency 80 %</p> <p>Peak intensity 1.3 cd/m</p> <p>LEDs/each optic 1</p> <p>Light colour White</p> <p>Required components: C13333_MIRELLA-CL</p>		
<p> SEOUL SEMICONDUCTOR</p> <p>LED ZC4/6</p> <p>FWHM / FWTM 42.0° / 82.0°</p> <p>Efficiency 86 %</p> <p>Peak intensity 1.4 cd/m</p> <p>LEDs/each optic 1</p> <p>Light colour White</p> <p>Required components:</p>		
<p>SHARP</p> <p>LED Mini Zenigata (GW5BM)</p> <p>FWHM / FWTM 45.0° / 78.0°</p> <p>Efficiency 84 %</p> <p>Peak intensity 1.3 cd/m</p> <p>LEDs/each optic 1</p> <p>Light colour White</p> <p>Required components: C12479_MIRELLA-DL</p>		
<p>SHARP</p> <p>LED Mini Zenigata (GW5BM)</p> <p>FWHM / FWTM 39.0° / 80.0°</p> <p>Efficiency 89 %</p> <p>Peak intensity 1.5 cd/m</p> <p>LEDs/each optic 1</p> <p>Light colour White</p> <p>Required components:</p>		

OPTICAL RESULTS (MEASURED):

SHARP

LED Mini Zenigata (GW6BM)
 FWHM / FWTM 45.0° / 80.0°
 Efficiency 81 %
 Peak intensity 1.1 cd/lm
 LEDs/each optic 1
 Light colour White
 Required components:
 C12479_MIRELLA-DL

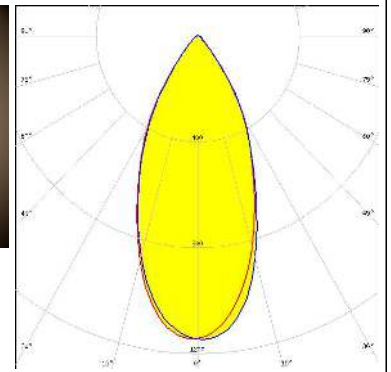
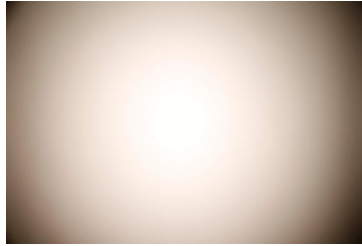

SHARP

LED Mini Zenigata (GW6BM)
 FWHM / FWTM 38.0° / 81.0°
 Efficiency 88 %
 Peak intensity 1.5 cd/lm
 LEDs/each optic 1
 Light colour White
 Required components:

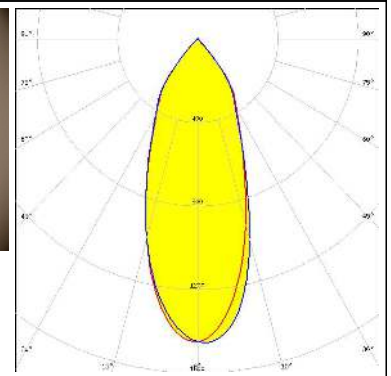
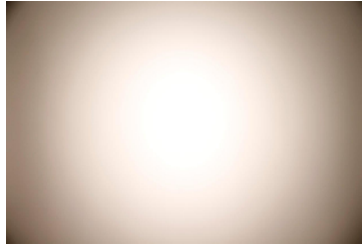

OPTICAL RESULTS (SIMULATED):

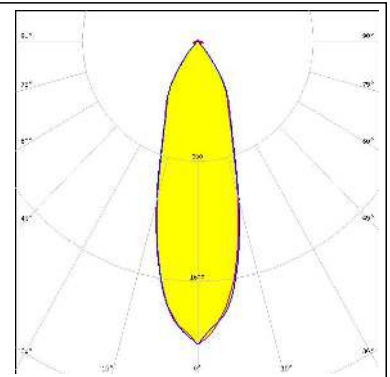
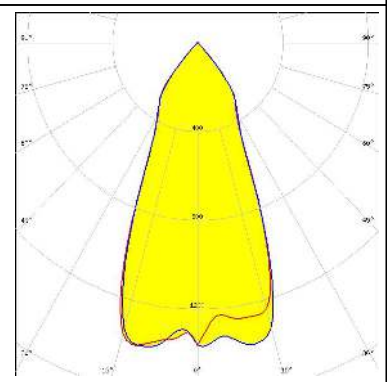
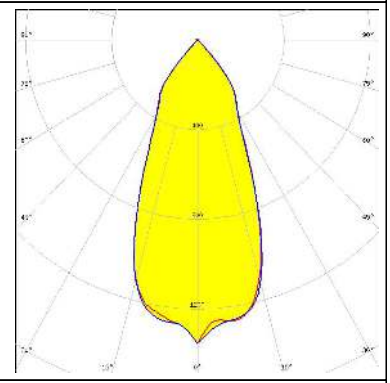
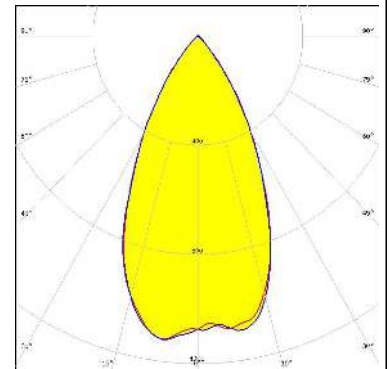
<p>bridgelux</p> <p>LED: Vero SE 10 FWHM / FWTM: 32.0° / 72.0° Efficiency: 91 % Peak intensity: 2 cd/lm LEDs/each optic: 1 Light colour: White Required components:</p>	
<p>LUMILEDS</p> <p>LED: LUXEON 7070 FWHM / FWTM: 46.0° / 83.0 + 82.0° Efficiency: 96 % Peak intensity: 1.4 cd/lm LEDs/each optic: 1 Light colour: White Required components:</p>	
<p>OSRAM <small>Opto Semiconductors</small></p> <p>LED: OSCONIQ P 7070 FWHM / FWTM: 45.0° / 84.0° Efficiency: 91 % Peak intensity: 1.4 cd/lm LEDs/each optic: 1 Light colour: White Required components:</p>	
<p>OSRAM <small>Opto Semiconductors</small></p> <p>LED: Soleriq S9 FWHM / FWTM: 51.0° / 80.0° Efficiency: 85 % Peak intensity: 1.1 cd/lm LEDs/each optic: 1 Light colour: White Required components: C12479_MIRELLA-DL</p>	

OPTICAL RESULTS (SIMULATED):

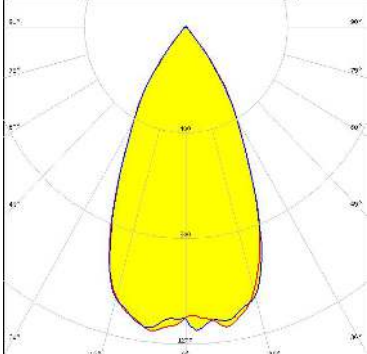
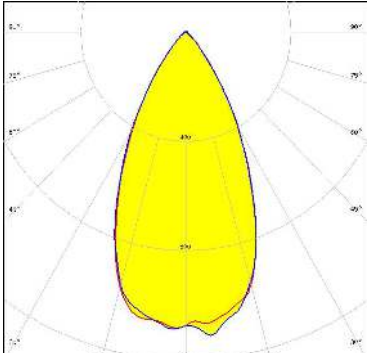
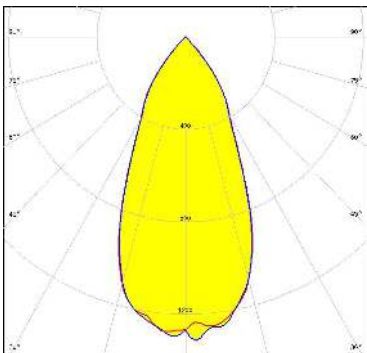
<p>OSRAM Opto Semiconductors</p> <p>LED Soleriq S9</p> <p>FWHM / FWTM 50.0° / 78.0°</p> <p>Efficiency 87 %</p> <p>Peak intensity 1.2 cd/lm</p> <p>LEDs/each optic 1</p> <p>Light colour White</p> <p>Required components: C13333_MIRELLA-CL</p>	
<p>OSRAM Opto Semiconductors</p> <p>LED Soleriq S9</p> <p>FWHM / FWTM 51.0° / 81.0°</p> <p>Efficiency 85 %</p> <p>Peak intensity 1.1 cd/lm</p> <p>LEDs/each optic 1</p> <p>Light colour White</p> <p>Required components: C13723_MIRELLA-RZL</p>	
<p>OSRAM Opto Semiconductors</p> <p>LED Soleriq S9</p> <p>FWHM / FWTM 47.0° / 83.0°</p> <p>Efficiency 91 %</p> <p>Peak intensity 1.3 cd/lm</p> <p>LEDs/each optic 1</p> <p>Light colour White</p> <p>Required components:</p>	

GENERAL INFORMATION:

NOTE: The typical beam angle will be changed by different color, chip size and chip position tolerance. The typical total beam angle is the full angle measured where the luminous intensity is half of the peak value.

Due to use of high power COB's with this product, special attention to proper thermal design is highly recommended. LEDiL has no liability for direct, indirect or consecutive damages arising from the LEDiL products being used outside of the recommended temperature range.

MATERIALS:

As part of our continuous research and improvement processes, and to ensure the best possible quality and availability of our products, LEDiL reserves the right to change material grades without notice.

PRODUCT DATA USER AGREEMENT AND DISCLAIMER:

The measured data in the provided downloadable LEDiL Product Datasheets and Mechanical 2D-Drawings is rounded and provided as reference for planning. LEDiL Oy's optical specifications have been verified by conducting performance testing of the products in accordance with the company's quality system. The reported data are averaged results of multiple measurements with typical variation. LEDiL Oy reserves the right to without prior notification make changes and improvements to its products.

LEDiL Oy assumes neither warranty, nor guarantee nor any other liability of any kind for the contents and correctness of the provided data. The provided data has been generated with highest diligence but the provided data may in reality not represent the complete possible variation range of all intrinsic parameters. Therefore, in certain cases a deviation from the provided data could occur.

LEDiL Oy reserves the right to undertake technical changes of its products without further notification which could lead to changes in the provided data. LEDiL Oy assumes no liability of any kind for the possible deviation from any provided data or any other damage resulting from the usage of the provided data.

The user agrees to this disclaimer and user agreement with the download or usage of the provided files.

LEDiL Oy

Joensuunkatu 13
FI-24240 SALO
Finland

LEDiL Inc.

228 West Page Street
Suite D
Sycamore IL 60178
USA

Ledil Optics Technology (Shenzhen) Co., Ltd.

405 , Block B
Casic Motor Building
Shenzhen 518057
P.R.CHINA

Local sales and technical support

[www.ledil.com/
where_to_buy](http://www.ledil.com/where_to_buy)

Shipping locations

Salo, Finland
Hong Kong, China

Distribution Partners

[www.ledil.com/
where_to_buy](http://www.ledil.com/where_to_buy)