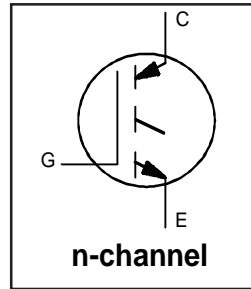


# IRGP4050PbF

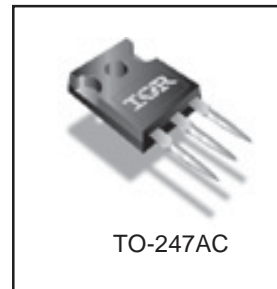
## PDP Switch

### Features

- Key parameters optimized for PDP sustain & Energy recovery applications
- 104A continuous collector current rating reduces component count
- High pulse current rating makes it ideal for capacitive load circuits
- Low temperature co-efficient of  $V_{CE(ON)}$  ensures reduced power dissipation at operating junction temperatures
- Reverse voltage avalanche rating improves the robustness in sustain driver application
- Short fall & rise times for fast switching
- Lead-Free



$V_{CES} = 250V$
$V_{CE(on) typ.} = 1.64V$
@ $V_{GE} = 15V, I_C = 30A$



### Description

This IGBT is specifically designed for sustain & energy recovery application in plasma display panels. This IGBT features low  $V_{CE(ON)}$  and fast switching times to improve circuit efficiency and reliability. Low temperature co-efficient of  $V_{CE(ON)}$  makes this IGBT an ideal device for PDP sustain driver application.

### Absolute Maximum Ratings

	Parameter	Max.	Units
$V_{CES}$	Collector-to-Emitter Voltage	250	V
$I_C @ T_C = 25^\circ C$	Continuous Collector Current	104*	A
$I_C @ T_C = 100^\circ C$	Continuous Collector Current	56	
$I_{CM}$	Pulse Collector Current ①	208	
$I_{LM}$	Clamped Inductive Load current ②	290	
$V_{GE}$	Gate-to-Emitter Voltage	$\pm 20$	
$E_{ARV}$	Reverse Voltage Avalanche Energy ③	1240	mJ
$P_D @ T_C = 25^\circ C$	Maximum Power Dissipation	330	W
$P_D @ T_C = 100^\circ C$	Maximum Power Dissipation	130	
$T_J$ $T_{STG}$	Operating Junction and Storage Temperature Range	-55 to +150	$^\circ C$
	Solder Temperature Range, for 10 sec.	300 (0.063 in. (1.6mm) from case)	

### Thermal / Mechanical Characteristics

	Parameter	Min.	Typ.	Max.	Units
$R_{\theta JC}$	Junction-to-Case- IGBT	—	—	0.38	$^\circ C/W$
$R_{\theta CS}$	Case-to-Sink, flat, greased surface	—	0.24	—	
$R_{\theta JA}$	Junction-to-Ambient, typical socket mount	—	—	40	
$Wt$	Weight	—	6 (0.21)	—	g (oz.)

\*Package limited to 60A.

# IRGP4050PbF

International  
IR Rectifier

## Electrical Characteristics @ $T_J = 25^\circ\text{C}$ (unless otherwise specified)

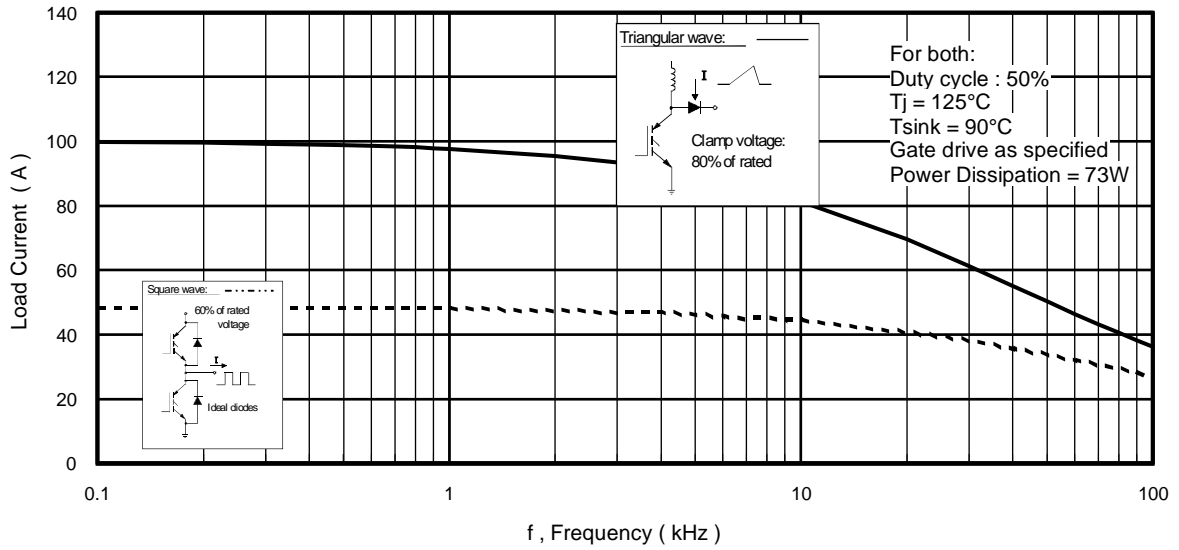
Parameter	Min.	Typ.	Max.	Units	Conditions	
$V_{(BR)CES}$	250	—	—	V	$V_{GE} = 0V, I_C = 250\mu A$	
$V_{(BR)ECS}$	18	—	—	V	$V_{GE} = 0V, I_C = 1.0A$	
$\Delta V_{(BR)CES}/\Delta T_J$	—	8.2	—	mV/ $^\circ\text{C}$	$V_{GE} = 0V, I_C = 1mA$	
$V_{CE(on)}$	Collector-to-Emitter Saturation Voltage	—	1.64	1.90	V	$I_C = 30A$ $I_C = 56A$ $I_C = 104A, T_J = 150^\circ\text{C}$ $V_{GE} = 15V$ See Fig. 2, 5
		—	2.04	—		
		—	2.60	—		
$V_{GE(th)}$	3.0	—	6.0		$V_{CE} = V_{GE}, I_C = 250\mu A$	
$\Delta V_{GE(th)}/\Delta T_J$	—	-11	—	mV/ $^\circ\text{C}$	$V_{CE} = V_{GE}, I_C = 0.25mA$	
$g_{fe}$	34	51	—	S	$V_{CE} = 100V, I_C = 56A$	
$I_{CES}$	Zero Gate Voltage Collector Current	—	—	250	$\mu A$	$V_{GE} = 0V, V_{CE} = 250V$
		—	—	2.0		$V_{GE} = 0V, V_{CE} = 10V$
		—	—	5000		$V_{GE} = 0V, V_{CE} = 250V, T_J = 150^\circ\text{C}$
$I_{GES}$	—	—	$\pm 100$	nA	$V_{GE} = \pm 20V$	

## Switching Characteristics @ $T_J = 25^\circ\text{C}$ (unless otherwise specified)

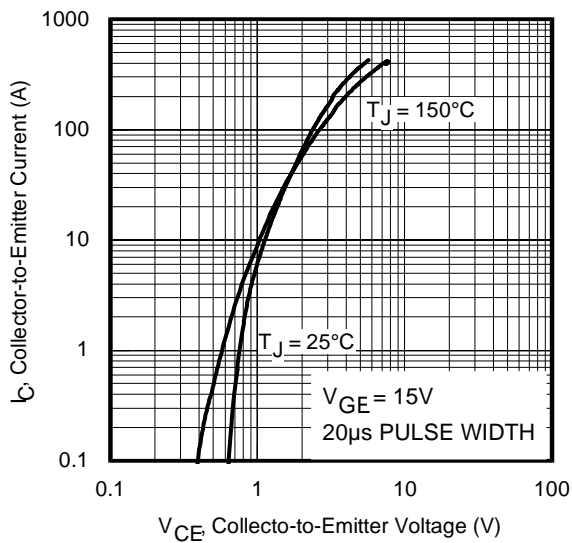
Parameter	Min.	Typ.	Max.	Units	Conditions
$Q_g$	—	230	350	nC	$I_C = 56A$ $V_{CC} = 200V$ $V_{GE} = 15V$ See Fig. 8
$Q_{ge}$	—	37	56		
$Q_{gc}$	—	78	120		
$t_{d(on)}$	—	37	—	ns	$T_J = 25^\circ\text{C}$ $I_C = 30A, V_{CC} = 180V$ $V_{GE} = 15V, R_G = 5.0\Omega$ Energy losses include "tail" See Fig. 9, 10, 14
$t_r$	—	35	—		
$t_{d(off)}$	—	120	180		
$t_f$	—	59	89		
$E_{on}$	—	45	—		
$E_{off}$	—	125	—	$\mu J$	
$E_{TS}$	—	170	—		
$t_{d(on)}$	—	35	—	ns	$T_J = 150^\circ\text{C}$ $I_C = 30A, V_{CC} = 180V$ $V_{GE} = 15V, R_G = 5.0\Omega$ Energy losses include "tail" See Fig. 11, 14
$t_r$	—	35	—		
$t_{d(off)}$	—	130	—		
$t_f$	—	120	—		
$E_{TS}$	—	280	—		
$L_E$	—	13	—	nH	Measured 5mm from package
$C_{ies}$	—	4650	—	pF	$V_{GE} = 0V$ $V_{CC} = 30V,$ $f = 1.0MHz$ See Fig. 7
$C_{oes}$	—	480	—		
$C_{res}$	—	92	—		

### Notes:

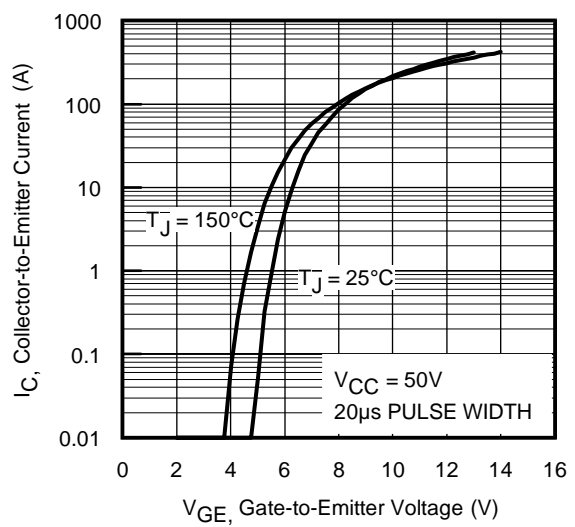
- ① Repetitive rating;  $V_{GE} = 20V$ , pulse width limited by max. junction temperature. ( See fig. 13b )
- ②  $V_{CC} = 80\%(V_{CES}), V_{GE} = 20V, L = 10\mu H, R_G = 5.0\Omega$ , (See fig. 13a).
- ③ Repetitive rating; pulse width limited by maximum junction temperature.
- ④ Pulse width  $\leq 2.5ms$ ; duty factor  $\leq 0.1\%$ .
- ⑤ Pulse width  $5.0\mu s$ , single shot.



**Fig. 1 - Typical Load Current vs. Frequency**  
(Load Current =  $I_{RMS}$  of fundamental)

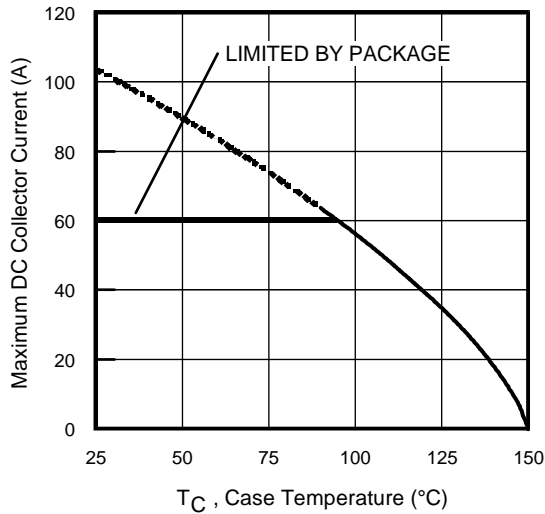


**Fig. 2 - Typical Output Characteristics**

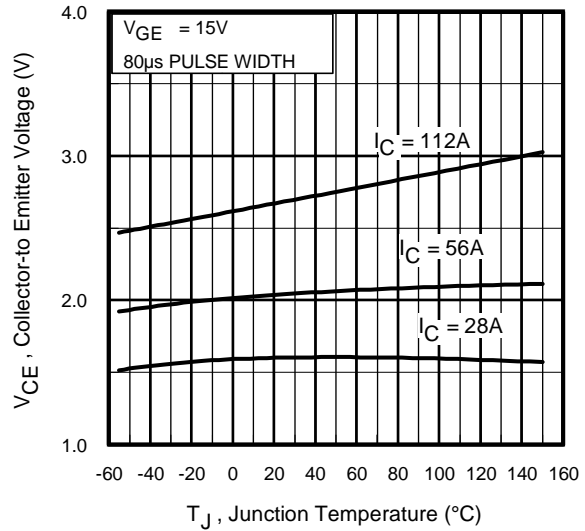


**Fig. 3 - Typical Transfer Characteristics**

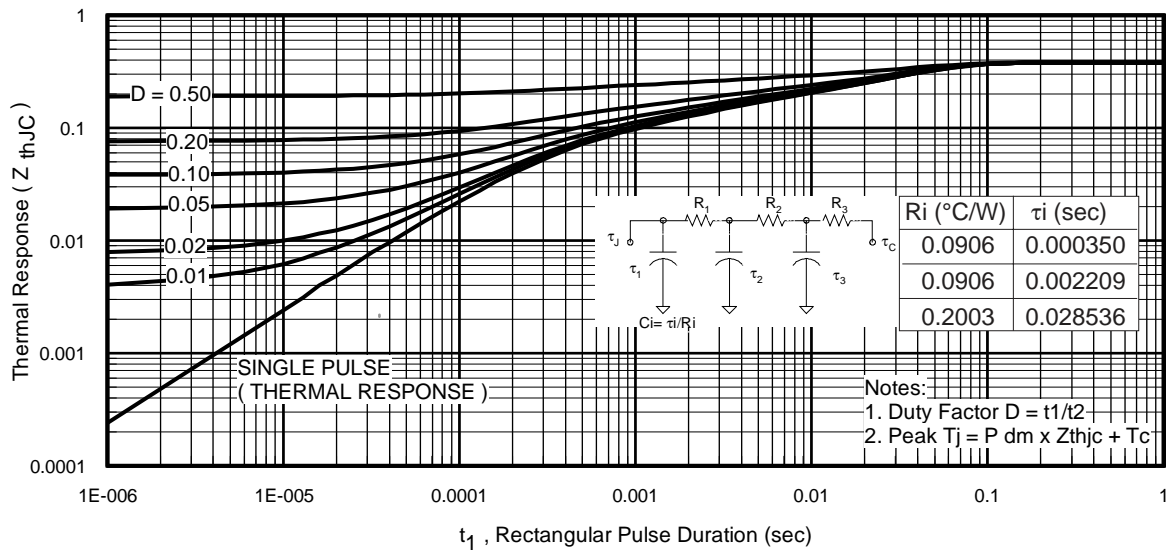
# IRGP4050PbF



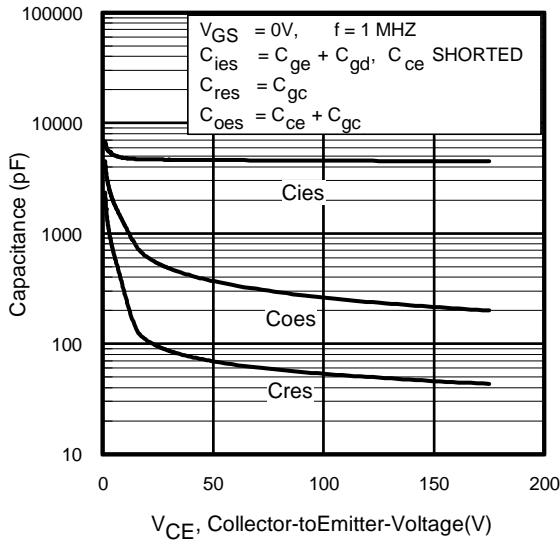
**Fig. 4 - Maximum Collector Current vs. Case Temperature**



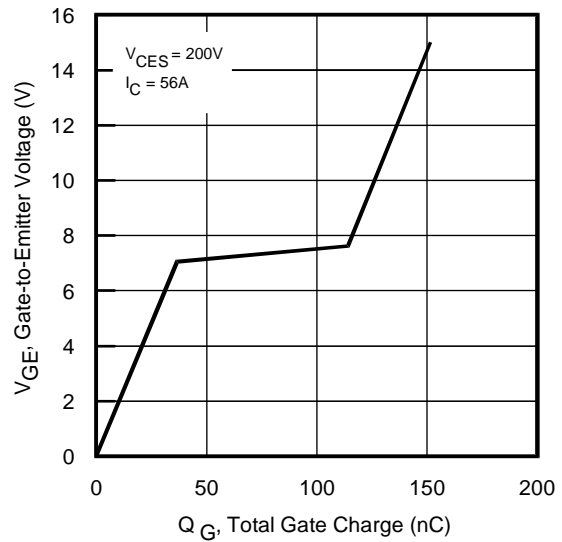
**Fig. 5 - Typical Collector-to-Emitter Voltage vs. Junction Temperature**



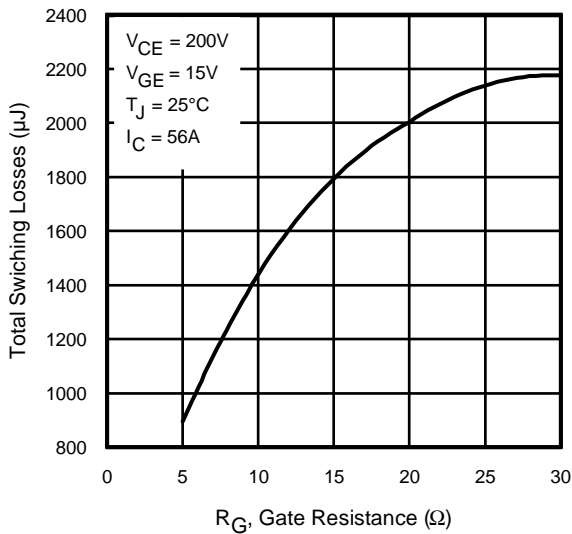
**Fig. 6 - Maximum Effective Transient Thermal Impedance, Junction-to-Case**



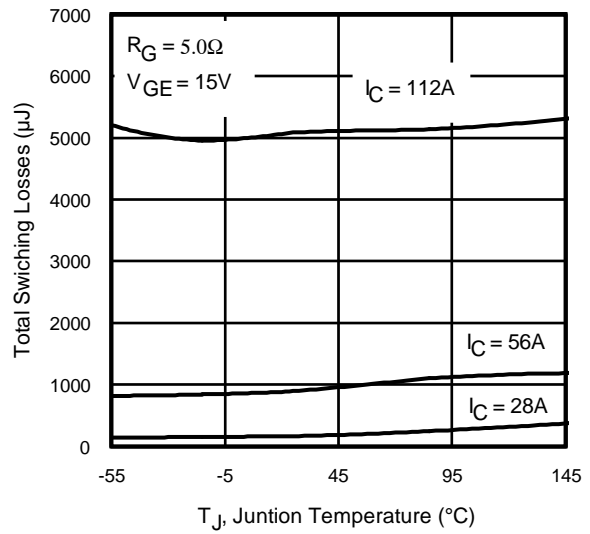
**Fig. 7** - Typical Capacitance vs. Collector-to-Emitter Voltage



**Fig. 8** - Typical Gate Charge vs. Gate-to-Emitter Voltage

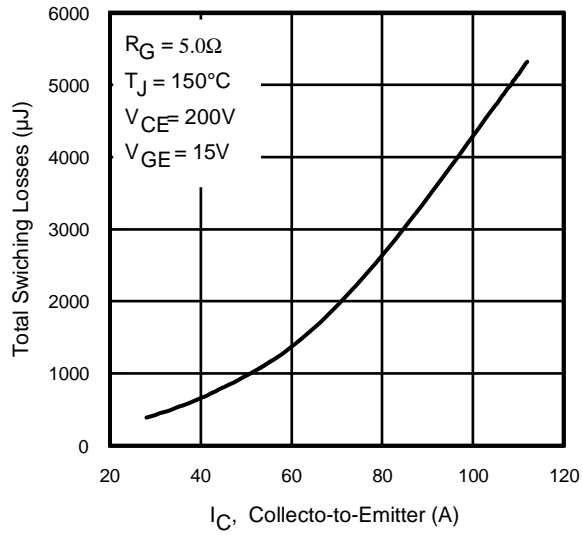


**Fig. 9** - Typical Switching Losses vs. Gate Resistance

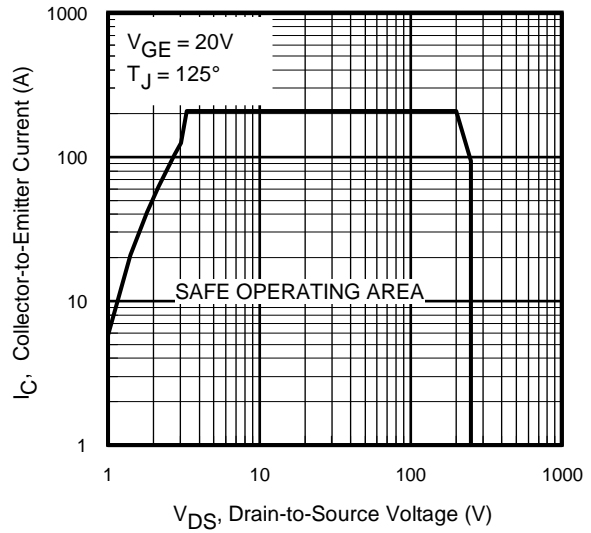


**Fig. 10** - Typical Switching Losses vs. Junction Temperature

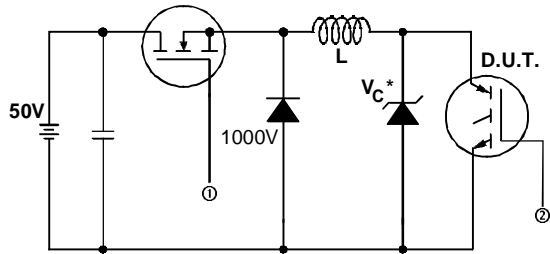
# IRGP4050PbF



**Fig. 11** - Typical Switching Losses vs. Collector-to-Emitter Current

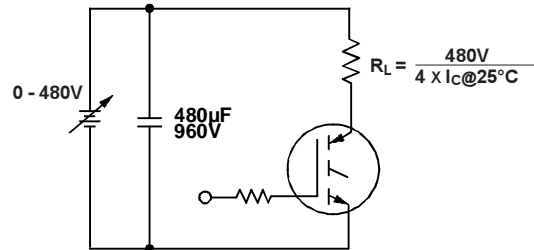


**Fig. 12** - Turn-Off SOA

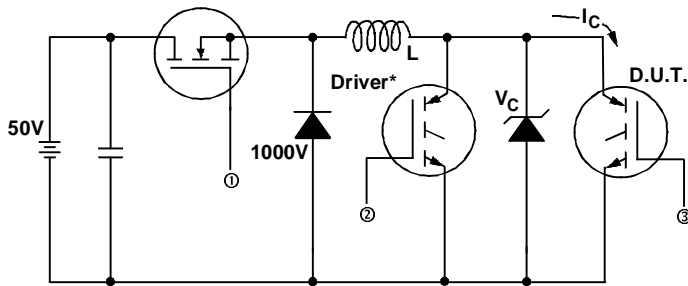


\* Driver same type as D.U.T.;  $V_c = 80\%$  of  $V_{ce(max)}$   
 \* Note: Due to the 50V power supply, pulse width and inductor will increase to obtain rated  $I_d$ .

**Fig. 13a** - Clamped Inductive Load Test Circuit

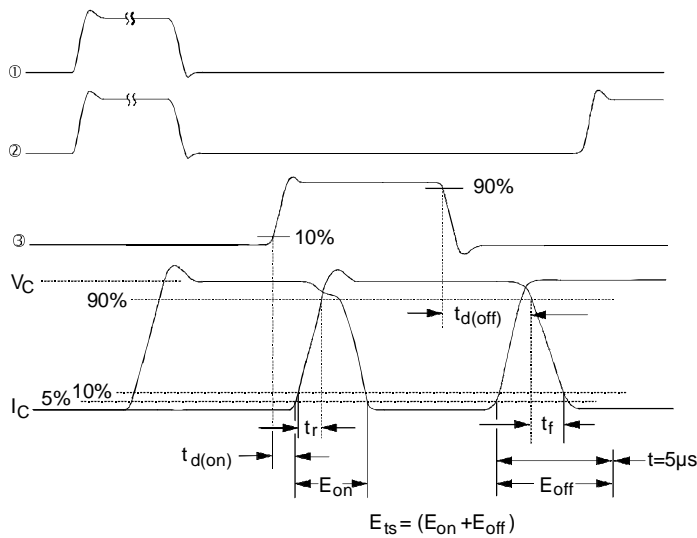


**Fig. 13b** - Pulsed Collector Current Test Circuit



**Fig. 14a** - Switching Loss Test Circuit

\* Driver same type as D.U.T.,  $V_C = 480V$

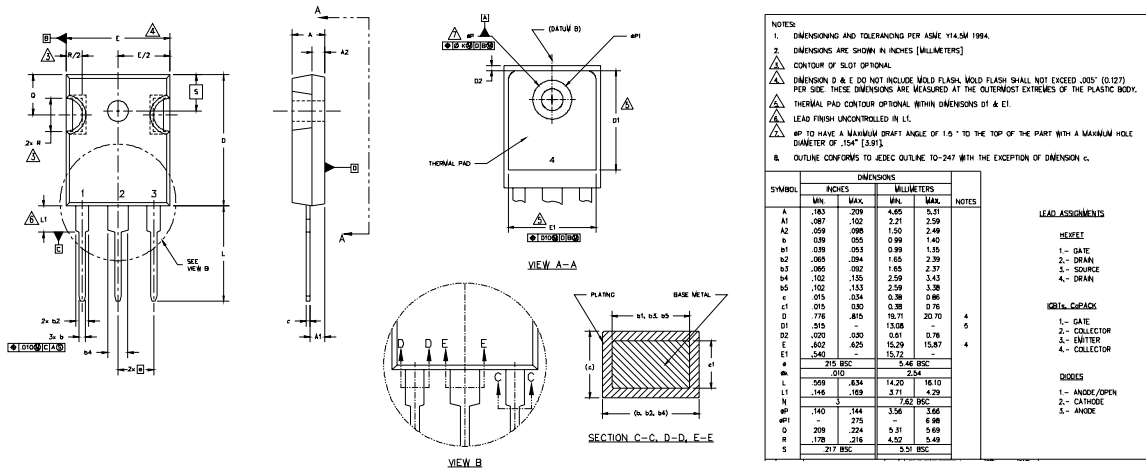


**Fig. 14b** - Switching Loss Waveforms

# IRGP4050PbF

## TO-247AC Package Outline

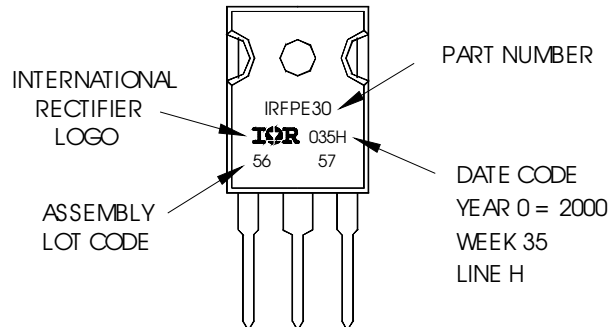
Dimensions are shown in millimeters (inches)



## TO-247AC Part Marking Information

EXAMPLE: THIS IS AN IRFP630  
WITH ASSEMBLY  
LOT CODE 5657  
ASSEMBLED ON WW 35, 2000  
IN THE ASSEMBLY LINE "H"

**Note:** "P" in assembly line position indicates "Lead-Free"



**TO-247AC package is not recommended for Surface Mount Application.**

Data and specifications subject to change without notice.  
This product has been designed and qualified for the Industrial market.  
Qualification Standards can be found on IR's Web site.



**IR WORLD HEADQUARTERS:** 233 Kansas St., El Segundo, California 90245, USA Tel: (310) 252-7105  
TAC Fax: (310) 252-7903

Visit us at [www.irf.com](http://www.irf.com) for sales contact information.08/04



Note: For the most current drawings please refer to the IR website at:  
<http://www.irf.com/package/>