

C3D06065A

3rd Generation 650 V, 6 A Silicon Carbide Schottky Diode

Description

With the performance advantages of a Silicon Carbide (SiC) Schottky Barrier diode, power electronics systems can expect to meet higher efficiency standards than Si-based solutions, while also reaching higher frequencies and power densities. SiC diodes can be easily paralleled to meet various application demands, without concern of thermal runaway. In combination with the reduced cooling requirements and improved thermal performance of SiC products, SiC diodes are able to provide lower overall system costs in a variety of diverse applications.

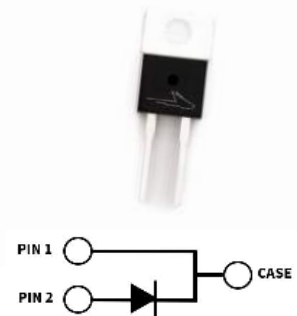

Package Types: TO-220-2
Marking: C3D06065A

Features

- Low Forward Voltage (V_F) Drop with Positive Temperature Coefficient
- Zero Reverse Recovery Current / Forward Recovery Voltage
- Temperature-Independent Switching Behavior

Applications

- Industrial Switched Mode Power Supplies
- Uninterruptible & AUX Power Supplies
- Boost for PFC & DC-DC Stages
- Solar Inverters

Maximum Ratings ($T_C = 25^\circ\text{C}$ Unless Otherwise Specified)

| Parameter | Symbol | Value | Unit | Test Conditions | Notes |
|---|-------------|-------|------|---|--------|
| Repetitive Peak Reverse Voltage | V_{RRM} | 650 | V | | |
| DC Blocking Voltage | V_{DC} | 650 | | | |
| Continuous Forward Current | I_F | 19 | A | $T_J = 25^\circ\text{C}$ | Fig. 3 |
| | | 9 | | $T_J = 135^\circ\text{C}$ | |
| | | 6 | | $T_J = 154^\circ\text{C}$ | |
| Repetitive Peak Forward Surge Current | I_{FRM} | 30 | A | $T_C = 25^\circ\text{C}, t_p = 10 \text{ ms}, \text{Half Sine Wave}$ | |
| | | 20 | | $T_C = 110^\circ\text{C}, t_p = 10 \text{ ms}, \text{Half Sine Wave}$ | |
| Non-Repetitive Forward Surge Current | I_{FSM} | 63 | A | $T_C = 25^\circ\text{C}, t_p = 10 \text{ ms}, \text{Half Sine Wave}$ | Fig. 8 |
| | | 49 | | $T_C = 110^\circ\text{C}, t_p = 10 \text{ ms}, \text{Half Sine Wave}$ | |
| Non-Repetitive Peak Forward Surge Current | $I_{F,Max}$ | 540 | A | $T_C = 25^\circ\text{C}, t_p = 10 \mu\text{s}, \text{Pulse}$ | |
| | | 460 | | $T_C = 110^\circ\text{C}, t_p = 10 \mu\text{s}, \text{Pulse}$ | |
| Power Dissipation | P_{tot} | 88 | W | $T_J = 25^\circ\text{C}$ | Fig. 4 |
| | | 38 | | $T_J = 110^\circ\text{C}$ | |

Electrical Characteristics

| Parameter | Symbol | Typ. | Max. | Unit | Test Conditions | Notes |
|-------------------------|--------|------|------|---------------|---|--------|
| Forward Voltage | V_F | 1.5 | 1.7 | V | $I_F = 6 \text{ A}, T_j = 25 \text{ }^\circ\text{C}$ | Fig. 1 |
| | | 2.0 | 2.4 | | $I_F = 6 \text{ A}, T_j = 175 \text{ }^\circ\text{C}$ | |
| Reverse Current | I_R | 8 | 40 | μA | $V_R = 650 \text{ V}, T_j = 25 \text{ }^\circ\text{C}$ | Fig. 2 |
| | | 15.5 | 160 | | $V_R = 650 \text{ V}, T_j = 175 \text{ }^\circ\text{C}$ | |
| Total Capacitive Charge | Q_C | 15 | | nC | $V_R = 400 \text{ V}, T_j = 25 \text{ }^\circ\text{C}$ | Fig. 5 |
| Total Capacitance | C | 295 | | pF | $V_R = 0 \text{ V}, T_j$ | |
| | | | | | | |
| | | | | | | |

Typical Performance

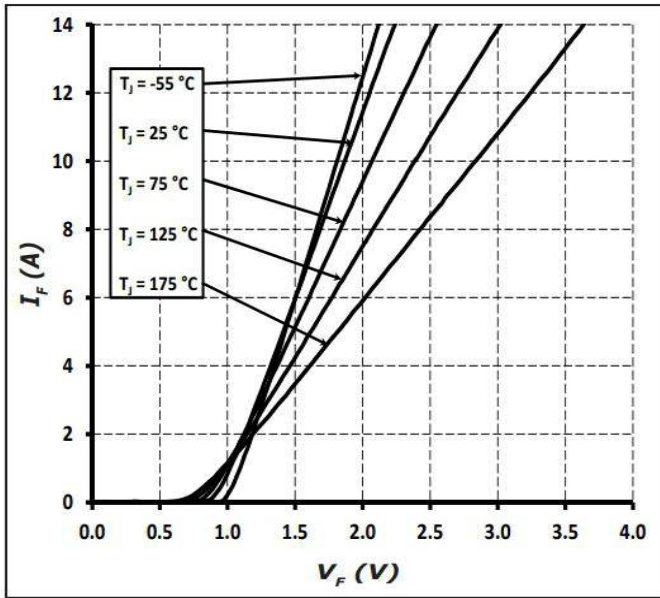

Figure 1
Forward Characteristics

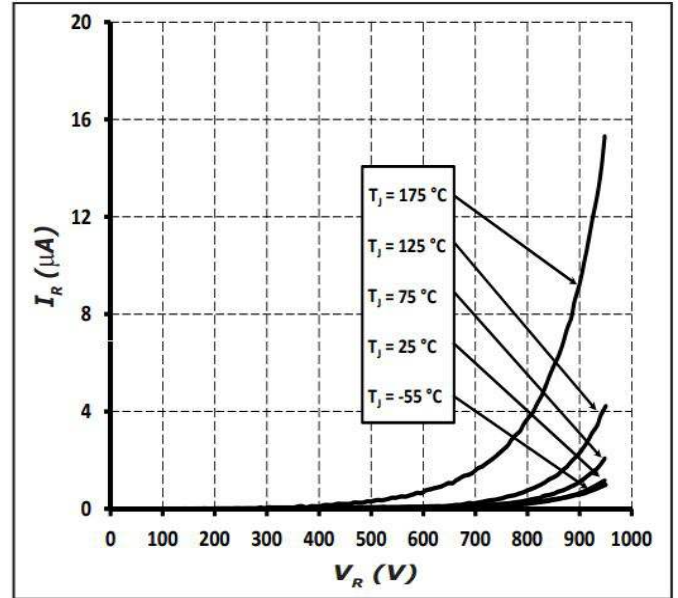

Figure 2
Reverse Characteristics

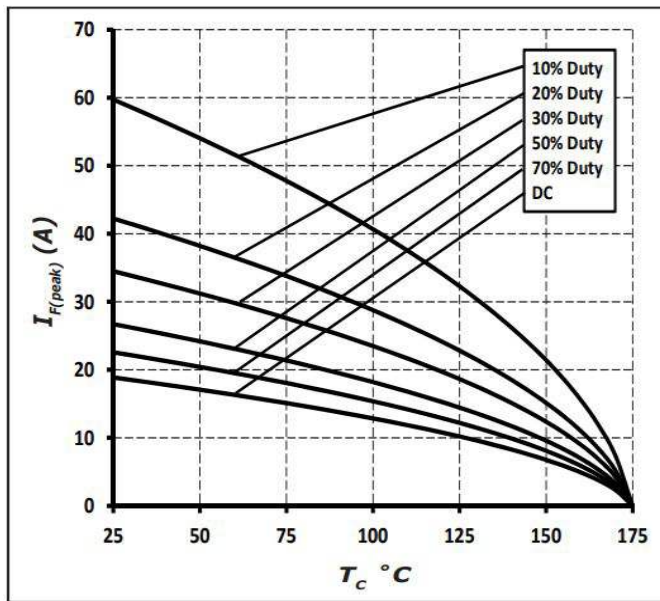

Figure 3
Current Derating

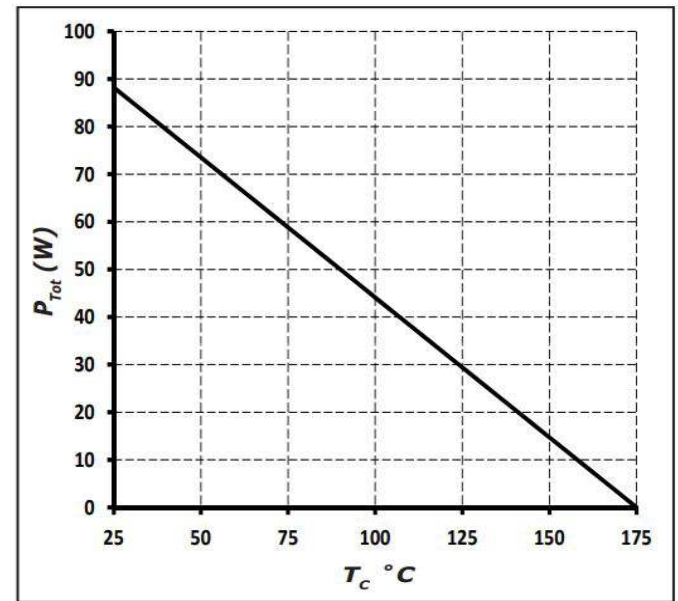

Figure 4
Power Derating

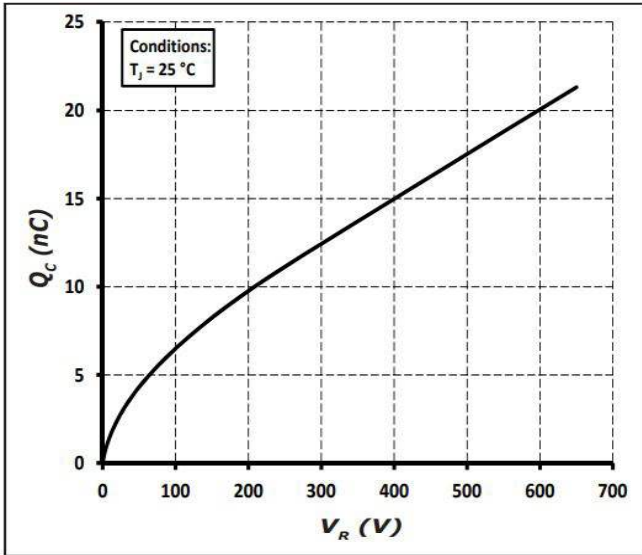

Figure 5

Total Capacitance vs. Reverse Voltage

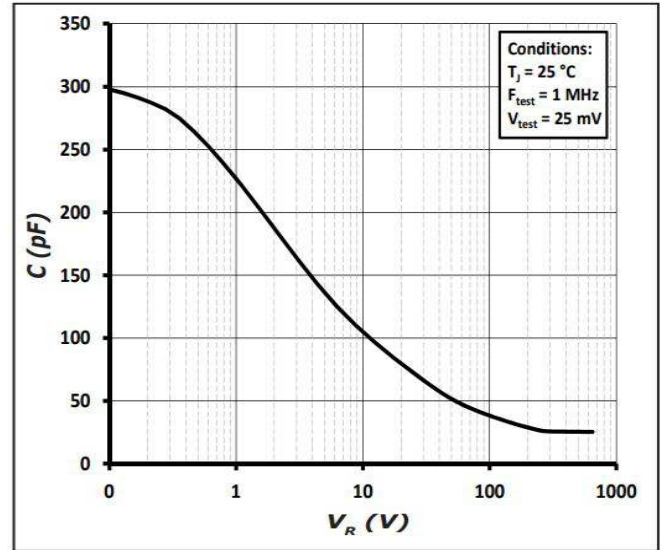

Figure 6

Capacitance vs. Reverse Voltage

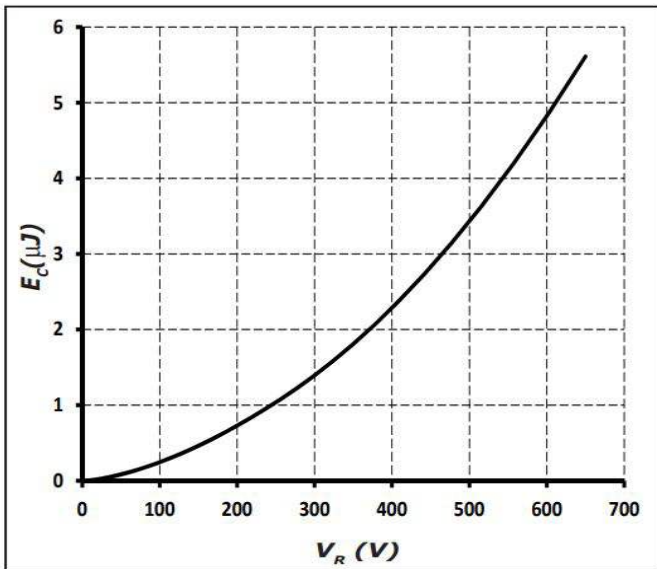

Figure 7

Capacitance Stored Energy

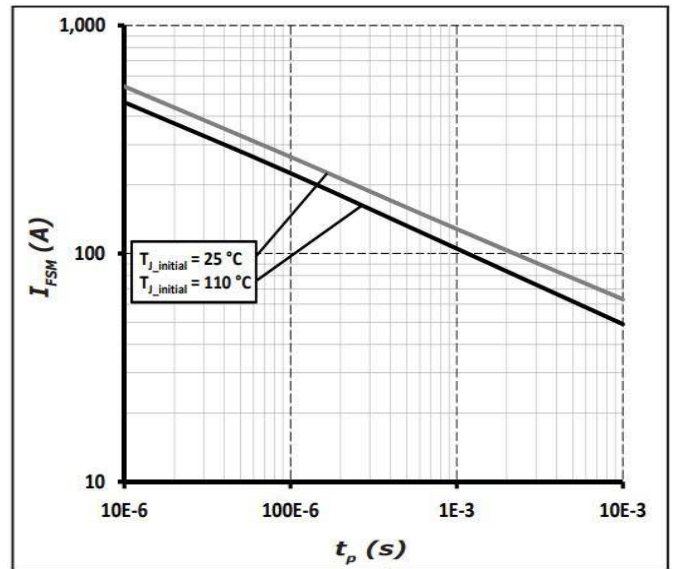

Figure 8

Non-Repetitive Peak Forward Surge Current versus Pulse Duration (sinusoidal waveform)

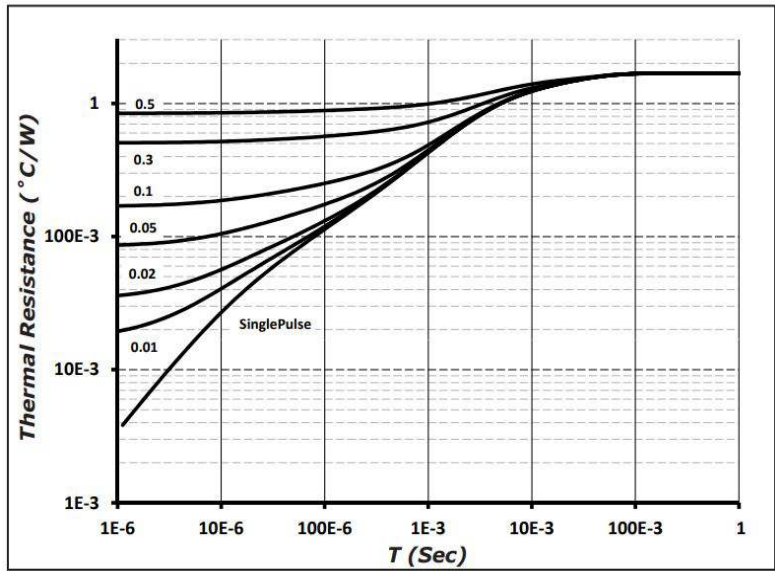
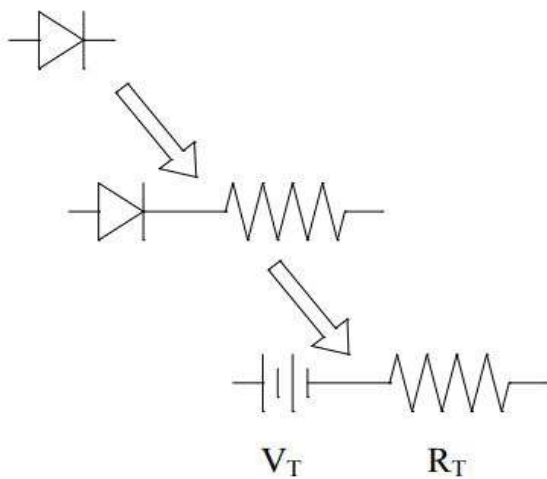

Figure 9
Transient Thermal Impedance

Diode Model



$$V_{f_T} = V_T + I_f * R_T$$

$$V_T = 0.96 + (T_J * -1.1 * 10^{-3})$$

$$R_T = 0.07 + (T_J * 7.4 * 10^{-4})$$

Note: T_J = Diode Junction Temperature In Degrees Celsius, valid from 25°C to 175°C

Package Dimensions & Pin-Out

Package: TO-220-2

P
Q

E1
E2

1/2
1/11

D

B
W

X

Y

NOTE

1. ALL METAL SURFACES ARE TIN PLATED (MATTE), EXCEPT AREA OF CUT.
2. DIMENSIONING & TOLERANCING CONFORM TO ASME Y14.5M-1994.
3. ALL DIMENSIONS ARE LISTED IN MILLIMETERS. ANGLES ARE IN DEGREES.
4. PACKAGE BURR FLASH SIZE (0.5 mm) IS NOT INCLUDED IN THE DIMENSIONS



Recommended Solder Pad Layout

Primary dimensions shown in mm.

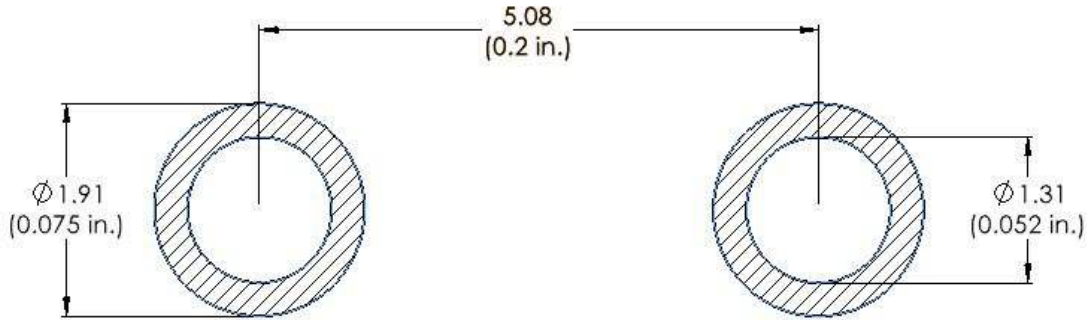

Product Ordering Information

| Order Number | Packing Type |
|--------------|--------------|
| C3D06065A | Tube |



Revision History

| Document Version | Date of Release | Description of Changes |
|------------------|-----------------|--|
| 1 | December-2015 | Initial Release |
| 6 | March-2023 | Update Package Drawing Update Landing Pad |



Notes & Disclaimer

This document and the information contained herein are subject to change without notice. Any such change shall be evidenced by the publication of an updated version of this document by Wolfspeed. No communication from any employee or agent of Wolfspeed or any third party shall effect an amendment or modification of this document. No responsibility is assumed by Wolfspeed for any infringement of patents or other rights of third parties which may result from use of the information contained herein. No license is granted by implication or otherwise under any patent or patent rights of Wolfspeed.

Notwithstanding any application-specific information, guidance, assistance, or support that Wolfspeed may provide, the buyer of this product is solely responsible for determining the suitability of this product for the buyer's purposes, including without limitation for use in the applications identified in the next bullet point, and for the compliance of the buyers' products, including those that incorporate this product, with all applicable legal, regulatory, and safety-related requirements.

This product has not been designed or tested for use in, and is not intended for use in, applications in which failure

Contact info:

4600 Silicon Drive
Durham, NC 27703 USA
Tel: +1.919.313.5300
www.wolfspeed.com/power