

Ideal for Industry & Audio!



ADQ-USB 3.0-ISO(-PS)

NEW: Re-clocking technology!

USB 3.0 up to 5 Gigabit/s

ADQ-USB 3.0-ISO-W

True USB 3.0 SuperSpeed transmission

Up to 900mA for USB 3.0 devices with ext. power supply

Isolation voltage (data and power supply)*: 1 kVDC

Blue power LEDs at host and device side

Ext. power supply alternatively 5VDC or 10..36VDC (-W)**

USB 3.0 SuperSpeed Isolator

USB 3.0 SuperSpeed Isolator for measurement, industry, automotive and audio technology

Features

- Latest isolator technology supports SuperSpeed USB 3.0 devices up to 5 Gbit/s
- Re-clocking technology for all speeds
- Downwards compatible with USB 2.0/1.1/1.0
- Isolation voltage (data and power supply)*: up to 1 kVDC continuously!
- ESD protection up to ± 15 kV according to IEC 61000-4-2
- Maximum current for USB 3.0 devices:
 - Without external power supply: max. 200 mA
 - With external power supply: max. 900 mA
- Operating temperature: -20°C..+70°C
- Rugged aluminum housing with rubber bumpers
- Operation system support: Windows, MAC OS and Linux

Application examples

- Electrical isolation between measurement instruments and PC
- Efficient suppression of ground loops – ideal for music studios and event technology
- Spike protection in the automotive area, e. g. for testing control units
- Decoupling of different ground levels in industrial control technology
- Can also be used as “power injector” for USB devices normally powered by the USB port but which doesn't provide enough current for a reliable operation of the USB device**

*ADQ-USB 3.0-ISO(-PS): 1 kVDC continuously /1.5 kVAC <60Hz (60s),
ADQ-USB 3.0-ISO-W: 1.6 kVAC (60s).

**ADQ-USB 3.0-ISO-PS: 5 V power adapter included.
ADQ-USB 3.0-ISO-W: External power supply must be provided.

Specifications

Element	ADQ-USB 3.0-ISO(-PS)	ADQ-USB 3.0-ISO-W
USB standard	USB 3.0 (downwards compatible to USB 2.0/1.1/1.0)	
Data rate ¹⁾	5 Gbit/s (SuperSpeed), 480 Mbit/s (High-Speed), 12 Mbit/s (Full-Speed) or 1.5 Mbit/s (Low-Speed); auto-negotiation of data rate ¹⁾	
Re-clocking technology	✓	✓
Communication	bidirectional (DFP)	
Isolation voltage	1 kVDC (continuous) 1.5 kVAC < 60 Hz (60 s) ⁴⁾	1.6 kVAC (60 s) ⁴⁾
ESD protection	±15 kV according to IEC 61000-4-2 air, ±12 kV according to IEC 61000-4-2 contact	
External power supply	U_EXT = 5VDC ±10% ²⁾ via 7W power supply with integrated isolation and filtering stage	U_EXT = 10..36VDC ³⁾ via ext. power supply with integrated isolation and filtering stage, power consumption max. 7 W
Connection ext. power supply	DC-plug with bayonet lock, contact diameter of the barrel connector at power supply's side: 5.5 mm OD, 2.5 mm ID	2-pin Phoenix type clamp (mating plug included); integrated reverse polarity protection
Max. current for USB device (downstream)	USB 2.0 powered: max. 180 mA, USB 3.0 powered: max. 200 mA, with ext. power supply: 900 mA	with external power supply: 900 mA (bus-powered not possible)
Connectors	Host (upstream): USB 3.0 type B female connector; Device (downstream): USB 3.0 type A female connector	
Power LED	+5V from host / +5V for device	+5V from host / +5V for device
Fuse	ext. DC input short-circuit-proof due to resettable fuse	
Protection of ext. DC input	reverse polarity / short-circuit	reverse polarity / short-circuit
Dimensions/Weight	90 mm x 62 mm x 32 mm (L x W x H incl. rubber bumpers) / 125 g	
Environmental conditions	Operating temperature: -20°C..+70°C, relative humidity: max. 95%	
Operation system support	Windows, MAC OS, Linux	
Certifications	EMC directive 2004/108/EG, emission EN 55022, noise immunity EN 50082-2, RoHS	

¹⁾ When connecting to an USB 2.0 host (upstream), no USB 3.0 devices are accepted at device side (downstream). The cascading of several USB isolators is not supported.
²⁾ External power supply for ADQ-USB 3.0-ISO-PS: If you require more than 200mA current for your USB device, we recommend to use the power adapter included. This medical certified power adapter provides 900 mA to your USB 3.0 device according to the USB standard. The usage of this power adapter guarantees that the specifications of the USB isolator are met.
³⁾ External power supply for ADQ-USB 3.0-ISO-W: For power supply of the USB device an external power supply in the range of 10..36VDC providing 7W minimum is required.
⁴⁾ Isolation voltage applies to data lines and power supply.

Block diagram

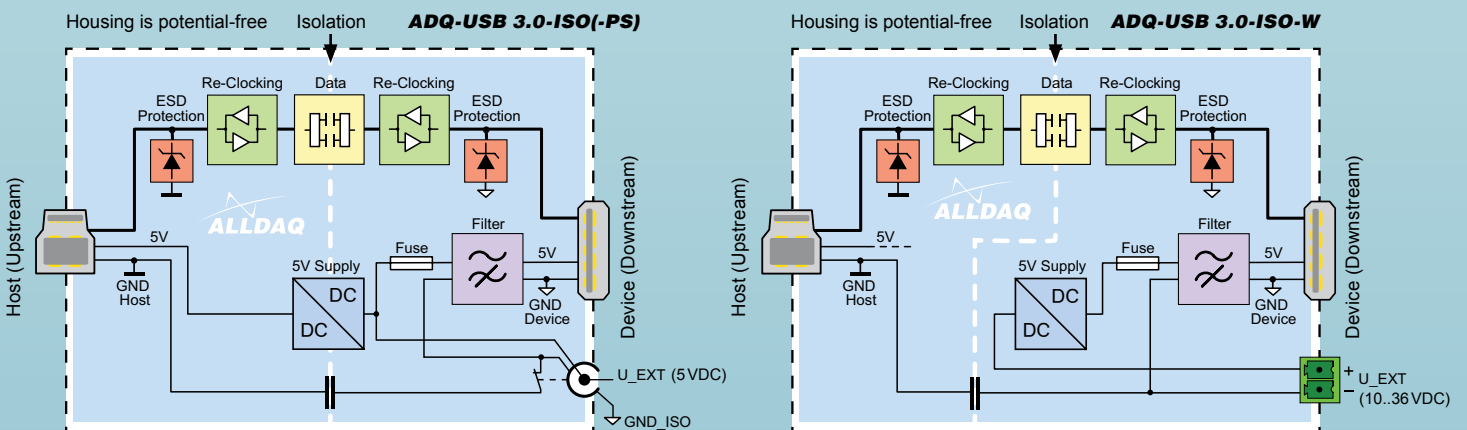

Application examples

Fail-safe measuring in laboratory



Fail-safe measuring in automotive field

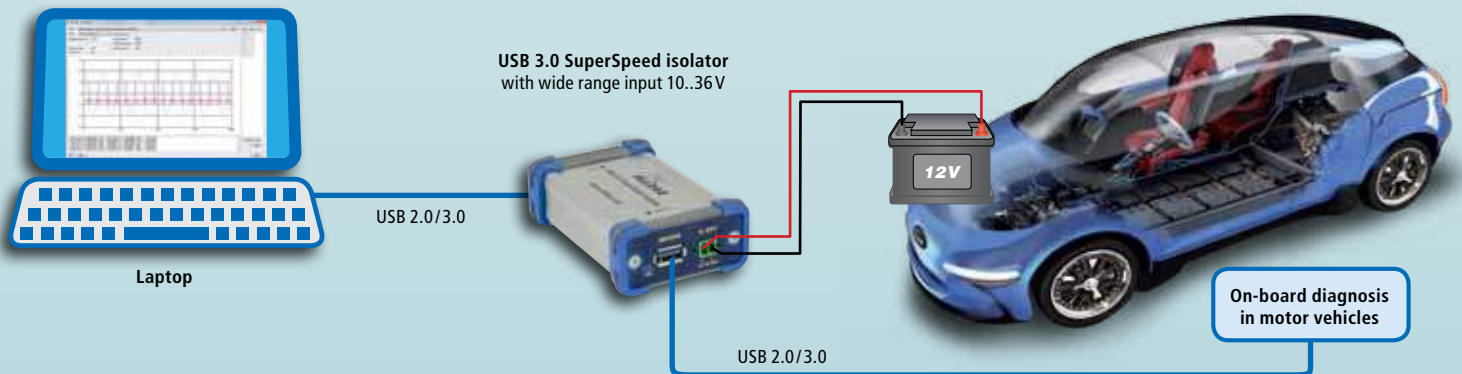

Enjoy music without ripple pickup

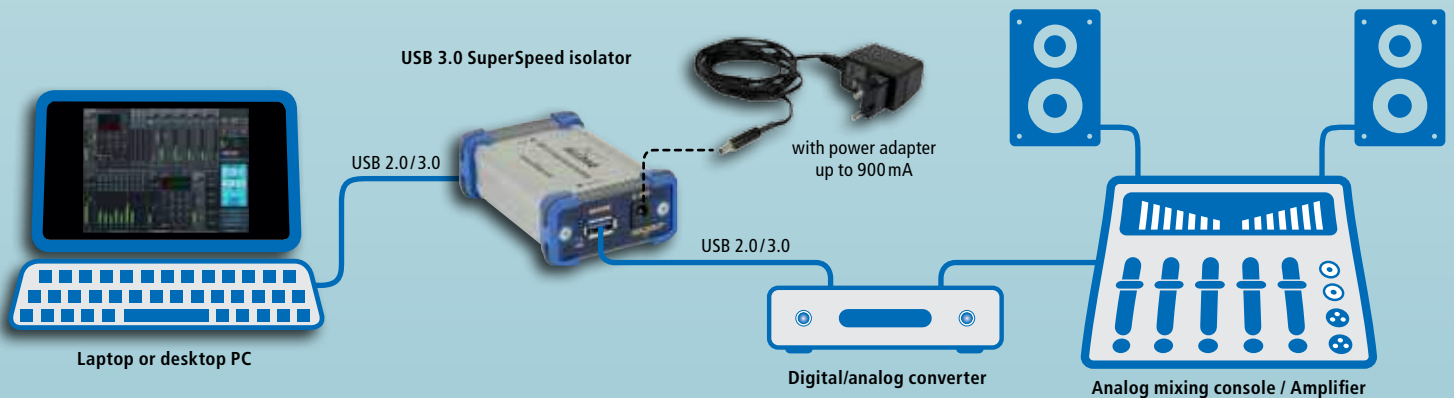

Scope of delivery

ADQ-USB 3.0-ISO(-PS)



USB 3.0 SuperSpeed isolator with 5 VDC input for ext. power supply

1.5 m USB 3.0 cable (double-shielded)

Recommended accessory ...

(included with article ADQ-USB 3.0-ISO-PS)

Power adapter (art. no.: 141119) with 1.8 m cable and lockable barrel connector (bayonet lock) for a safe power supply.

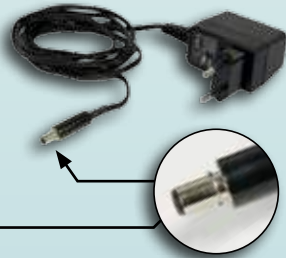

ADQ-USB 3.0-ISO-W

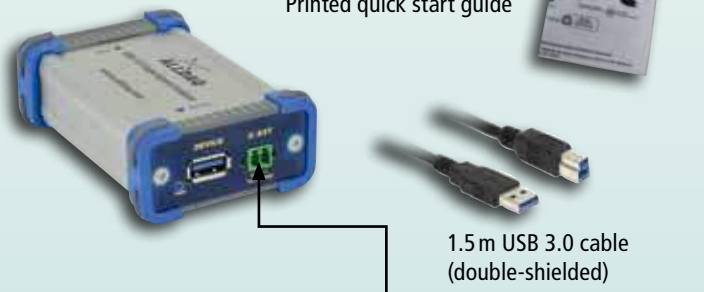

USB 3.0 SuperSpeed isolator with 10..36VDC wide range input for ext. power supply

1.5 m USB 3.0 cable (double-shielded)

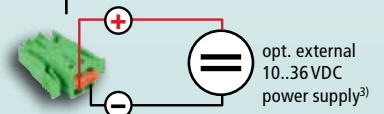

2-pin mating plug lockable included (Würth part no. 691 304 130 002, series 3041 - 3.50 mm, 2-pin)

Mounting kit for ADQ-USB-ISO series

The mounting kit is used for quick and secure mounting of ALLDAQ USB isolators on DIN rail. If required, you can mount the holder with a stainless steel plate to fix the cables with cable ties.



ADQ-USB-ISO-HUT (Art. No. 143417)

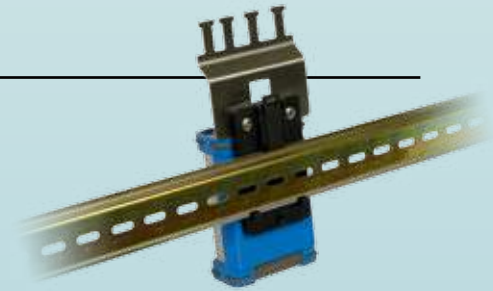

DIN rail not included

Ordering infos

	Art. No.	Description
ALLDAQ ADQ-USB 3.0-ISO-PS	143382	USB 3.0 SuperSpeed isolator up to 5 Gbit/s, ext. 5VDC input, incl. matching 5V power adapter (ALLDAQ zbh. PA-5V1,4A-BJ), 1.5m USB 3.0 cable double-shielded (USB 3.0-A male connector to USB 3.0-B male connector), quick start guide
ALLDAQ ADQ-USB 3.0-ISO	141116	USB 3.0 SuperSpeed isolator up to 5 Gbit/s, ext. 5VDC input, incl. 1.5 m USB 3.0 cable double-shielded (USB 3.0-A male connector to USB 3.0-B male connector), quick start guide
ALLDAQ ADQ-USB 3.0-ISO-W	141117	USB 3.0 SuperSpeed isolator up to 5 Gbit/s, ext. 10..36VDC input, incl. 1.5 m USB 3.0 cable double-shielded (USB 3.0-A male connector to USB 3.0-B male connector), quick start guide

Recommended power adapter for ADQ-USB 3.0-ISO (included with art. no. 143382)

ALLDAQ zbh. PA-5V1,4A-BJ	141119	Power adapter with medical certification according to IEC60601-1, ES60601-1, class II, primary: 100-240V 50/60Hz, secondary: 5 VDC/1.4 A, 5.5 mm barrel connector with bayonet lock, 1.8 m cable, EU primary adapter
--------------------------	--------	--

Accessories for ADQ-USB-ISO series (optional)

ALLDAQ zbh. ADQ-USB-ISO-HUT	143417	Mounting kit for ADQ-USB-ISO series on DIN rail, includes plastic tray (blue), mounting rail adapter (TS35) 45 mm wide, stable strain relief made of stainless steel
-----------------------------	--------	--

Warning: The USB isolators of the ADQ-USB-ISO series are not certified for use in medical applications.