

963357-6 ✓ ACTIVE



Timer Connector System

TE Internal #: 963357-6

PCB Mount Header, Vertical, Wire-to-Board, 4 Position, 5.6 mm [.22 in] Centerline, Fully Shrouded, Silver, Timer Connector System

[View on TE.com >](#)

Connectors > PCB Connectors > PCB Headers & Receptacles > Low & Medium Power Header

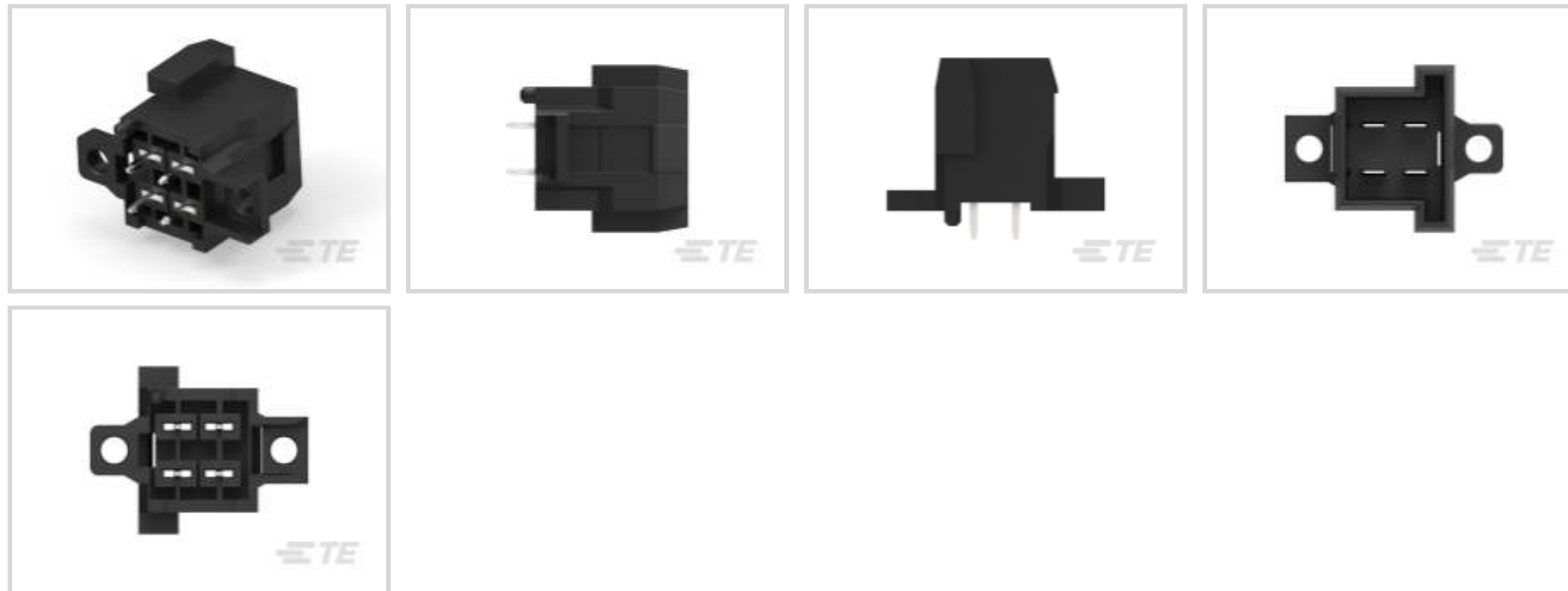

Connector System: **Wire-to-Board**

Number of Positions: **4**

Centerline (Pitch): **5.6 mm [.22 in]**

Sealable: **No**

PCB Mount Orientation: **Vertical**

[All Low & Medium Power Header \(169\)](#)

Features

Product Type Features

Hybrid Header	No
Connector Shape	Rectangular
PCB Connector Assembly Type	PCB Mount Header
Header Type	Fully Shrouded
Connector System	Wire-to-Board
Sealable	No
Connector & Contact Terminates To	Printed Circuit Board

Configuration Features

Number of Sections	1
Number of Positions	4
PCB Mount Orientation	Vertical
Number of Rows	2

Body Features



Primary Product Color	Black
-----------------------	-------

Contact Features

Contact Size	1.6mm, 3mm
Contact Type	Tab
Mating Tab Width	3 mm[.118 in]
Mating Tab Thickness	.8 mm[.031 in]
Contact Mating Area Plating Material	Silver

Termination Features

Termination Method to Printed Circuit Board	Through Hole - Solder
---	-----------------------

Mechanical Attachment

Mounting Holes	With
Mating Retention	With
Mating Alignment	With
PCB Mount Retention	With
Mating Retention Type	Locking Interface

Housing Features

Centerline (Pitch)	5.6 mm[.22 in]
--------------------	----------------

Dimensions

Connector Length	26.1 mm[1.358 in]
Connector Width	20 mm[.787 in]
Profile Height from PCB	18.3 mm[.72 in]

Operation/Application

Shielded	No
Circuit Application	Signal

Packaging Features

Packaging Quantity	819
--------------------	-----

Other

Interface Number	929504
------------------	--------

Product Compliance

[For compliance documentation, visit the product page on TE.com>](#)

EU RoHS Directive 2011/65/EU	Compliant
------------------------------	-----------



EU ELV Directive 2000/53/EC	Compliant
China RoHS 2 Directive MIIT Order No 32, 2016	No Restricted Materials Above Threshold
EU REACH Regulation (EC) No. 1907/2006	Current ECHA Candidate List: JUNE 2023 (235) Candidate List Declared Against: JUNE 2023 (235) Does not contain REACH SVHC
Halogen Content	Low Halogen - Br, Cl, F, I < 900 ppm per homogenous material. Also BFR/CFR/PVC Free
Solder Process Capability	Wave solder capable to 260°C

Product Compliance Disclaimer

This information is provided based on reasonable inquiry of our suppliers and represents our current actual knowledge based on the information they provided. This information is subject to change. The part numbers that TE has identified as EU RoHS compliant have a maximum concentration of 0.1% by weight in homogenous materials for lead, hexavalent chromium, mercury, PBB, PBDE, DBP, BBP, DEHP, DIBP, and 0.01% for cadmium, or qualify for an exemption to these limits as defined in the Annexes of Directive 2011/65/EU (RoHS2). Finished electrical and electronic equipment products will be CE marked as required by Directive 2011/65/EU. Components may not be CE marked. Additionally, the part numbers that TE has identified as EU ELV compliant have a maximum concentration of 0.1% by weight in homogenous materials for lead, hexavalent chromium, and mercury, and 0.01% for cadmium, or qualify for an exemption to these limits as defined in the Annexes of Directive 2000/53/EC (ELV). Regarding the REACH Regulation, the information TE provides on SVHC in articles for this part number is based on the latest European Chemicals Agency (ECHA) 'Guidance on requirements for substances in articles' posted at this URL: <https://echa.europa.eu/guidance-documents/guidance-on-reach>

Compatible Parts



TE Part # CAT-T4827-CH8172
Timer Connector Housing

Also in the Series | Timer Connector System



Automotive Connector Caps & Covers (12)

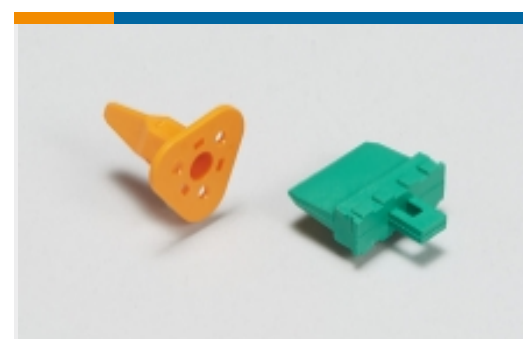

Automotive Connector Locks & Position Assurance(17)



Automotive Housings(237)



Automotive Terminals(145)

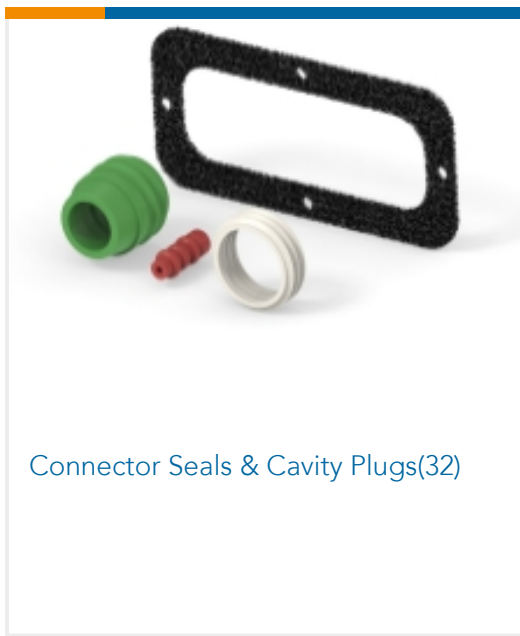

Connector Seals & Cavity Plugs(32)

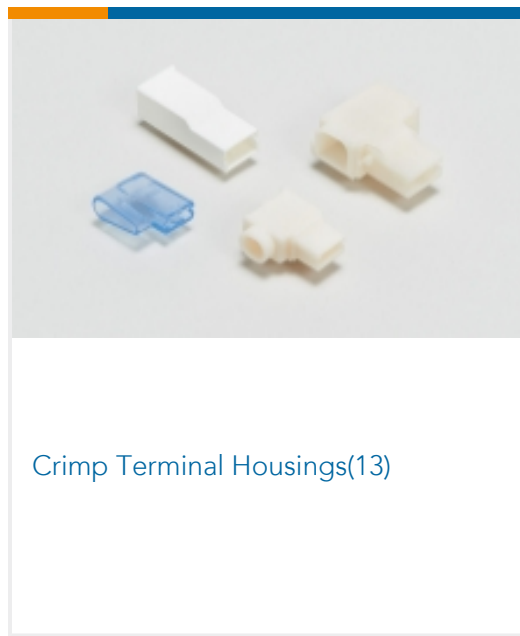

Crimp Terminal Housings(13)

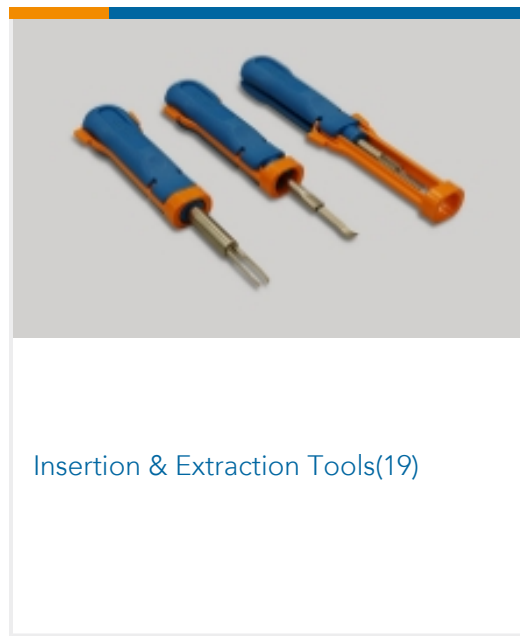

Insertion & Extraction Tools(19)



Other Automotive Connector Accessories(1)



PCB Headers & Receptacles(82)

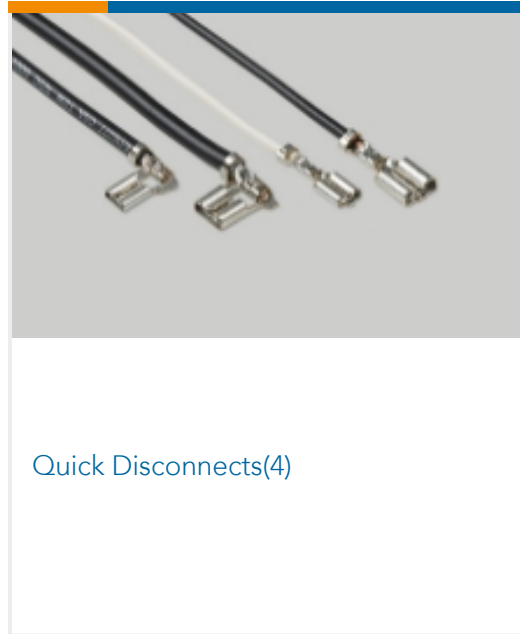

Quick Disconnects(4)

Customers Also Bought



TE Part #828801-5
Low & Medium Power Header



TE Part #2176157-7
TLM 2010 0.75W R033 5% 100PPM 4K RL



TE Part #6-1879214-9
CPF 0402 1K87 0.1% 25PPM 1K RL

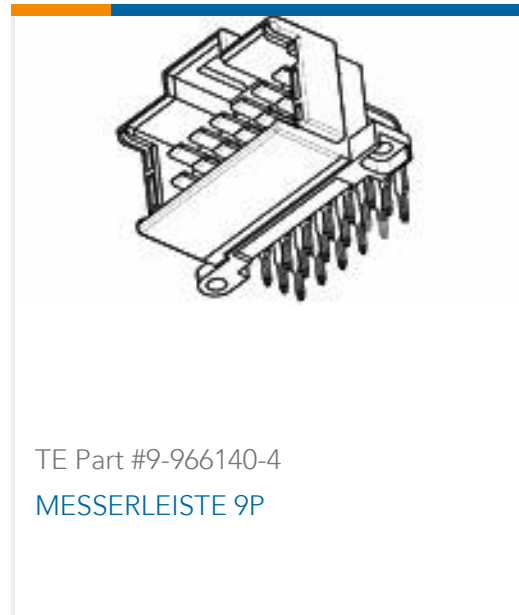

TE Part #9-966140-4
MESSERLEISTE 9P



TE Part #4-1415898-4
RTS3L006

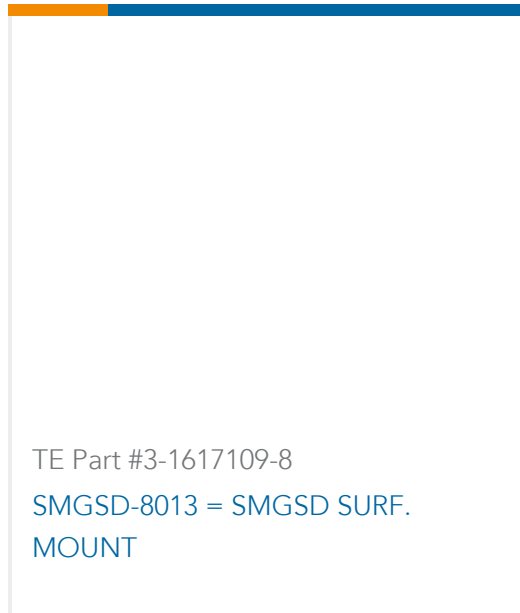

TE Part #3-1617109-8
SMGSD-8013 = SMGSD SURF. MOUNT

Documents

Product Drawings

[2X 2P MESSERLEISTE](#)

English

CAD Files

Customer View Model

[ENG_CVM_CVM_963357-6_A.2d_dxf.zip](#)

English

[3D PDF](#)



3D

Customer View Model

[ENG_CVM_CVM_963357-6_A.3d_igs.zip](#)

English

Customer View Model

[ENG_CVM_CVM_963357-6_A.3d_stp.zip](#)

English

By downloading the CAD file I accept and agree to the [Terms and Conditions](#) of use.