

Classification		Issue No.
<b>References</b>		
Part Name	Part No.	
<b>Infrared Array Sensor Grid-EYE Unit Type</b>	<b>AMGU4241</b>	9-1

1. Part Name : Infrared Array Sensor Grid-EYE Unit Type

2. Part No. : AMGU4241

3. Characteristics

3-1 Ratings

Item	unit	Specification			Remarks
		Min.	Typ.	Max.	
Power supply voltage	VDC	21.6	24	26.4	-
Current Consumption	mA	-	25	50	-
Contact capacity	-	-	-	DC24V 0.1A	Photo MOS Relay
Person detectable surrounding temperature (spec. guaranteed temp.)	degC	+10 to +29			no condensation
Operating temperature (at power-on)	degC	0 to +50			no freezing and condensation
Storage temperature (at power-off)	degC	-20 to +70			no freezing and condensation

Classification		References		Issue No.
Part Name		Part No.		
Infrared Array Sensor Grid-EYE Unit Type		AMGU4241		9-2

### 3-2 Basic specifications

Item	Unit	Specification			Remarks	
		Min.	Typ.	Max.		
Installation height	m			2.7		*4
Detection range	m	3.6x3.6			At 1.6m distance from ceiling	*4
Moving velocity of target	m/s			1.7	*1	*4
Location accuracy		Target heat source: 400mmx400mm heater (Difference temp.: 4degC)				
	mm		+/-300		-	*4
		Target heat Source: Human				
	mm		+/-500		-	*4
Area resolution	-	Division into 16(4x4)			-	
Indicator light	-	Red (when detected human)			-	*4
Address setting range	-	1 to 63			sets up by DIPSW	
Wiring length(MAX)	m			500	*2	
Applicable electric wire	-	Power, Contact output line : $\phi$ 0.65 to 0.9 RS485 communication line : $\phi$ 0.65 to 0.9 (CPEV)			*3	
External Dimensions	mm	$\phi$ 120x63.5			-	
Weight	g	About 190				
Installation hole size	mm	$\phi$ 100 +5/-0			-	
Ceiling thickness	mm			30	-	

\*1. The sensor would not be able to detect human who walks faster than 1.7m/s.

\*2. Shall be tested/evaluated the performance of customer's system which incorporates Grid-EYE unit, and also checked the specification of the controller device to be connected.

\*3. Shall be used CPEV cable with shield for RS485 communication line.

\*4. Condition: detective temperature range 10 to 29 degC

## References

Part Name

Infrared Array Sensor Grid-EYE Unit Type

Part No.

AMGU4241

9-3

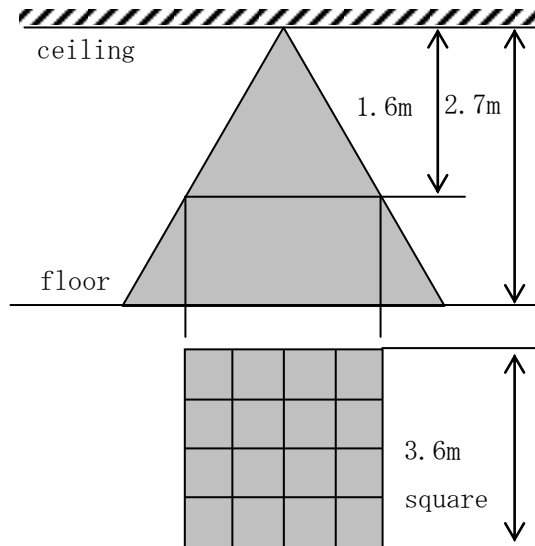
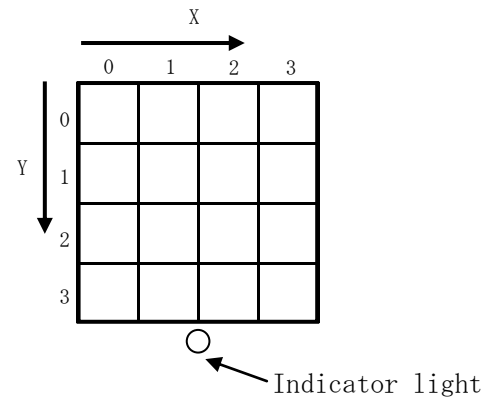
Detection range (image)Coordinates (image)

## 3-3 Communication specification

item	unit	specification
electric specifications	-	Follow RS-485
Protocol	-	MODBUS (RTU)
Baud rate	bps	38400
Data length	Bit	8
Start bit	Bit	1
Stop bit	Bit	1
Parity check	Bit	1
Parity	-	Odd
Flow control	-	none

-Grid-EYE unit works as a Slave. (Controller: Master)

-Shall be checked communication with the controller device to be connected.

Classification		Issue No.
<b>References</b>		
Part Name	Part No.	
<b>Infrared Array Sensor Grid-EYE Unit Type</b>	<b>AMGU4241</b>	9-4

### 3-4 Communication format

#### 3-4-1 Master (controller) to Slave (Grid-EYE unit)

The master can request all the data to the sensor using this format.

Function code	Data Address (starting address)		No. of Registers		CRC check	
Slave Address	0x03	Hi	Lo	Hi	Lo	CRC check
1byte	1byte	2byte		2byte		2byte

#### 3-4-2 Slave (Grid-EYE unit) to Master (controller)

Function code	Byte Count	Data 1		Data 2		...	CRC check	
Slave Address	0x03		Hi	Lo	Hi	Lo	...	CRC check
1byte	1byte	1byte	2byte		2byte			2byte

#### 3-4-3 Data address and corresponded data

data address	contents	kind of data	data range: hexadecimal
0000	Number of person	Unsigned 16bits	0H to 0008H
0001	Human coordinates	Unsigned 32bits	0H to FFFFFFFFH
0002			
0003	Exist/absence data	Unsigned 16bits	0H to FFFFH
0004	Moving directions	Unsigned 32bits	0H to FFFFFFFFH
0005			
0006	Temperature data	Signed 16bits	0H to FFFFH

#### 3-5 Contents of communication data

Grid-EYE unit sends the data of below 1)-5) requested by Master (controller).

##### 1) Number of person; 0 to 8

"0x00" & "0x0F" are sent until human detection operation starts after power-on.

7	6	5	4	3	2	1	0
0	0	0	0	0	0	0	0
0	0	0	0	n3	n2	n1	n0

} 2bytes

Classification	<b>References</b>		Issue No.
Part Name	Part No.		
<b>Infrared Array Sensor Grid-EYE Unit Type</b>	<b>AMGU4241</b>	9-5	

2) human's coordinates (8 persons)

Grid-EYE unit outputs human's detected position with XY coordinates, and sequentially outputs the coordinates for the detected number of person in clause 1) from (Xad1, Yad1) in order.

Undetected data position is set to (0, 0).

Data (0, 0) to be determined/judged at system side whether undetected data (0, 0) or detected data of coordinates (0, 0), based on the data for detected number of person in clause 1);

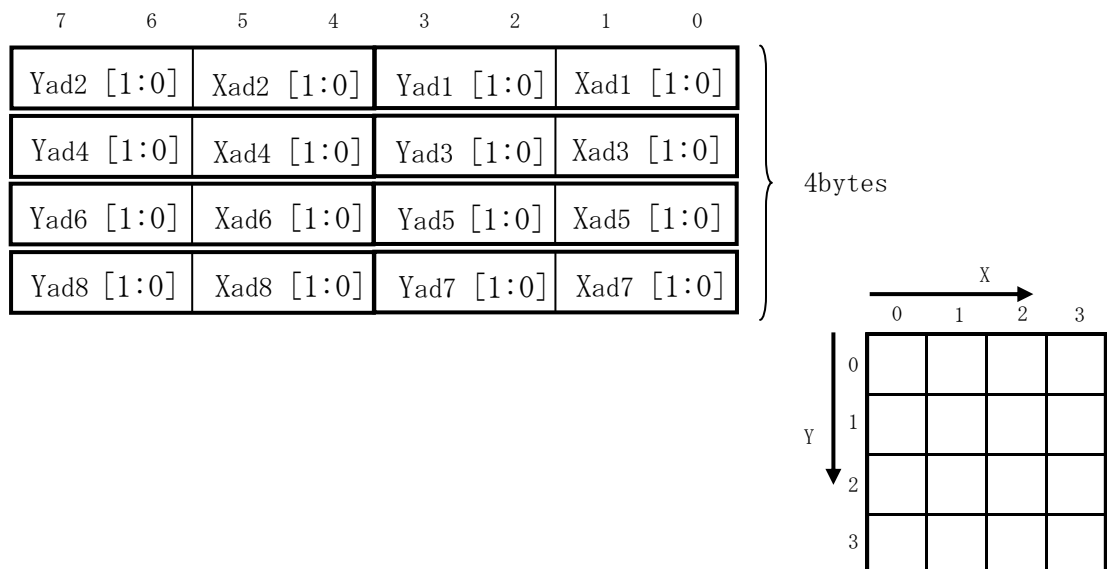

3) exist/absence data

Grid-EYE unit outputs the person exist/absence data in the divided 16 area.

0: absence, 1: exist

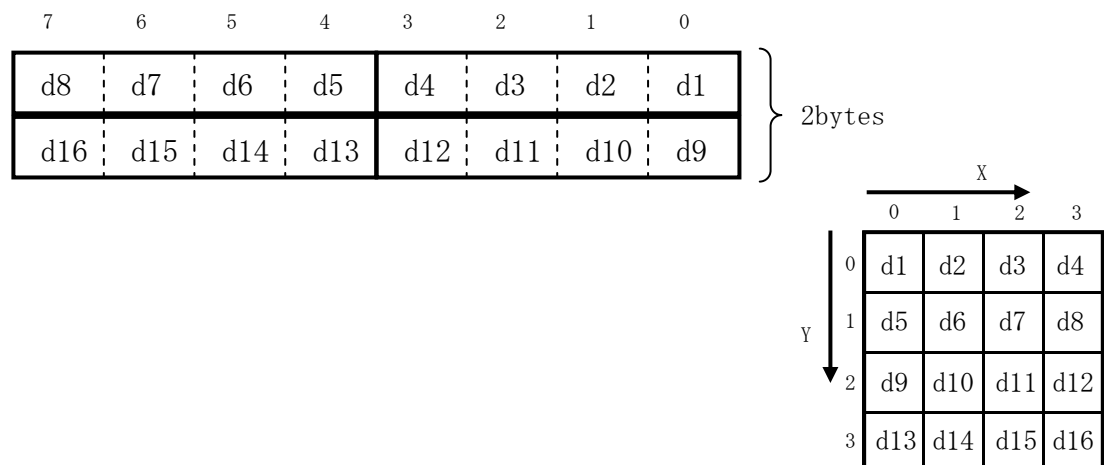

References

Part Name

Part No.

Infrared Array Sensor Grid-EYE Unit Type

AMGU4241

9-6

4) Moving direction

Grid-EYE outputs person moving direction with total 9 codes, 8 directions surrounding current position and staying current position.

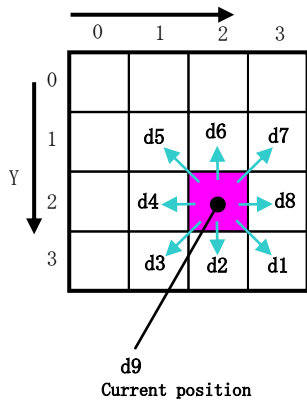
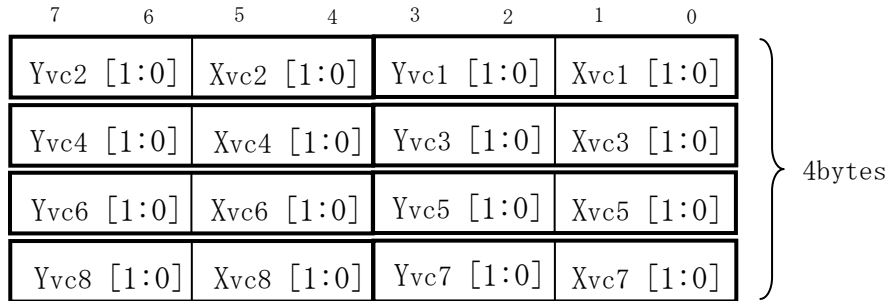

Moving direction: (Xvc, Yvc)

*decimal number	*signed binary number
d1 ( 1 , 1 )	d1 ( 01 , 01 )
d2 ( 0 , 1 )	d2 ( 00 , 01 )
d3 ( -1 , 1 )	d3 ( 11 , 01 )
d4 ( -1 , 0 )	d4 ( 11 , 00 )
d5 ( -1 , -1 )	d5 ( 11 , 11 )
d6 ( 0 , -1 )	d6 ( 00 , 11 )
d7 ( 1 , -1 )	d7 ( 01 , 11 )
d8 ( 1 , 0 )	d8 ( 01 , 00 )
d9 ( 0 , 0 )	d9 ( 00 , 00 )

When the data undetected of Moving direction:

*decimal number	*signed binary number
( -2 , -2 )	( 10 , 10 )

5) Temperature data

Average data of whole detection area to be outputted.

Measurement temperature range: 0 to 50 degC

\*two's complement data in case of temperature below zero.

(Not guaranteed data due to out of temp. spec. range)

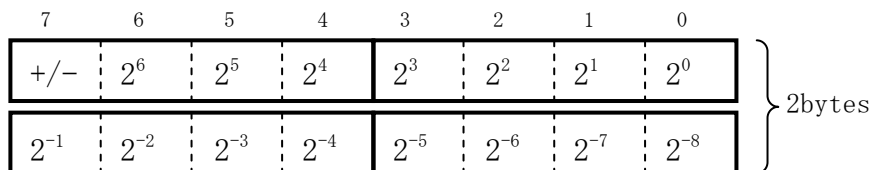

Classification	<b>References</b>		Issue No.
Part Name <b>Infrared Array Sensor Grid-EYE Unit Type</b>	Part No. <b>AMGU4241</b>	9-7	

### 3-6 Wiring diagram

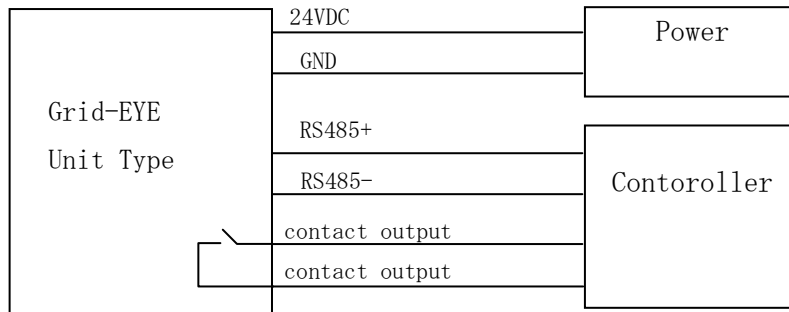

### 3-6-1 Terminal Arrangement

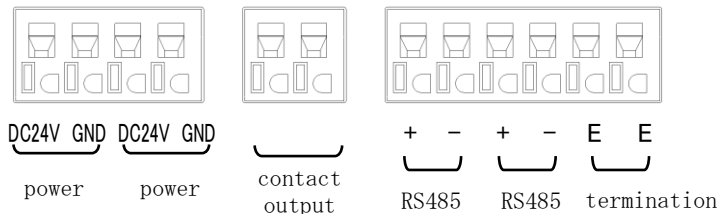

### 3-6-2 Wiring to RS485 communication line

- Be sure to use a twisted-pair cable with a shield.
- Be sure to ground a shield one side.
- Be sure to be exclusive D-class grounding with ground resistance of 100ohm or less.
- Be sure to make wiring into cascade connection.  
(Don't make wiring into star connection.)
- Be sure to be short-circuit between the send terminal(+,-) and the termination terminal(E,E) of a sensor connected to the end of the wiring.

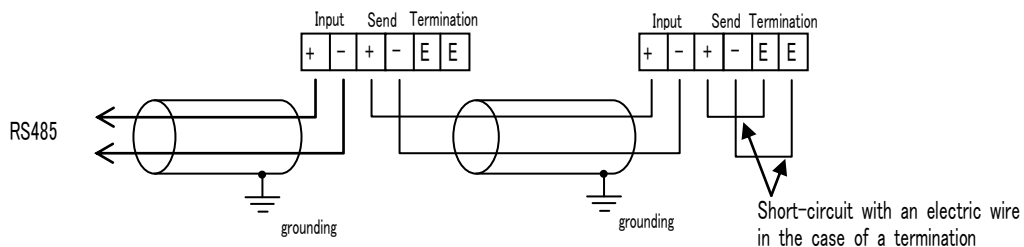

### 3-6-3 Address setup



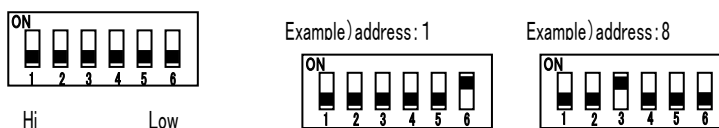





To be set up in 6-bit DIPSW (1 to 63).

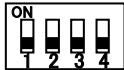
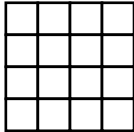

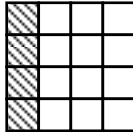
3-6-4 Area mask setup

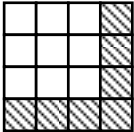
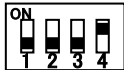
The mask of the detection area can be set by 4-bit DIPSW.

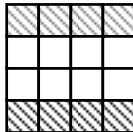
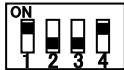
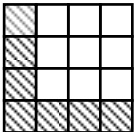
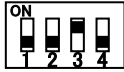
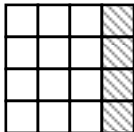
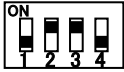
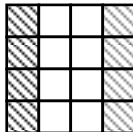
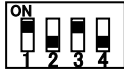
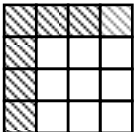
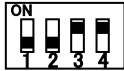
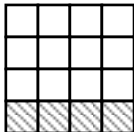
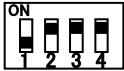
(Shading area can not be detected)

setteing	Mask area	setteing	Mask area	setteing	Mask area
					
					
					
					



Classification

Issue No.

References

Part Name

Part No.

Infrared Array Sensor Grid-EYE Unit Type

AMGU4241

9-9

4. Figure

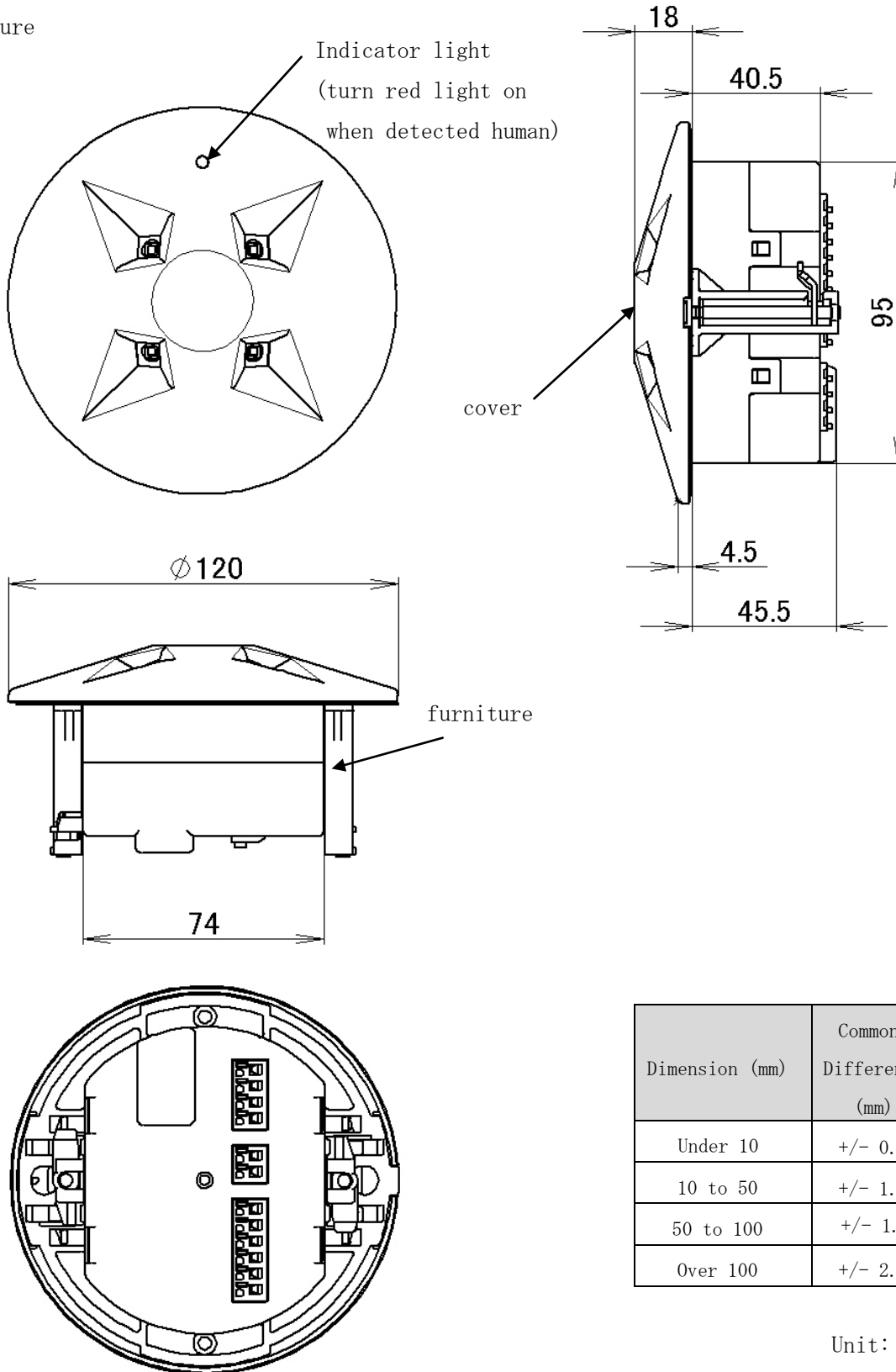

Dimension (mm)	Common Difference (mm)
Under 10	+/- 0.6
10 to 50	+/- 1.0
50 to 100	+/- 1.6
Over 100	+/- 2.0

Unit: mm