

LM48822

*LM48822 Ground-Referenced, Ultra High PSRR, Ultra Low Noise,
35mW/Channel Stereo Headphone Amplifier with Common Mode Sense, and I 2 C
Volume Control*



Literature Number: SNAS456B

Ground-Referenced, Ultra High PSRR, Ultra Low Noise, 35mW/Channel Stereo Headphone Amplifier with Common Mode Sense, and I²C Volume Control

General Description

The LM48822 is a single supply, ground-referenced stereo headphone amplifier designed for portable devices, such as cell phones, where board space is at a premium. The LM48822 features National's ground-referenced architecture, which eliminates the large DC blocking capacitor required by traditional headphone amplifiers, saving board space and minimizing system cost.

The LM48822 features common-mode sensing that corrects for any differences between the amplifier ground and the potential at the headphone return terminal, minimizing noise created by any ground mismatches.

The LM48822 delivers 35mW/channel into a 16Ω load with <1% THD+N with a 3.6V supply. High power supply rejection ratio (PSRR), of 110dB at 217Hz, allows the device to operate in noisy environments without additional power supply conditioning. Flexible power supply requirements allow operation from 2.4V to 5.5V. The LM48822 has a differential inputs for improved noise rejection. High output impedance in Shutdown mode, combined with a charge pump-only mode allows the LM48822's outputs to be driven by an external source without degrading the source signal. Additionally, the LM48822 features a 64-step I²C volume control and mute function. The low power Shutdown mode reduces supply current consumption to 0.06μA.

Superior click and pop suppression eliminates audible transients on power-up/down and during shutdown. The LM48822 is available in an ultra-small 16-bump micro SMD package (2mmx2mm).

Key Specifications

■ Output Power/channel at $V_{DD} = 3.6V$ $R_L = 16\Omega$, THD+N ≤ 1%	35mW (typ)
■ Output Power/channel at $V_{DD} = 3.6V$ $R_L = 32\Omega$, THD+N ≤ 1%	40mW (typ)
■ Quiescent Power Supply Current at 3.6V	3.5mA (typ)
■ PSRR at 217Hz	110dB (typ)
■ Shutdown current	0.06μA (typ)

Features

- Ground Referenced Outputs – Eliminates Output Coupling Capacitors
- Common-Mode Sense
- Ultra-High PSRR
- I²C Volume and Mode Control
- High Output Impedance in Shutdown
- Differential Inputs
- Advanced Click-and-Pop Suppression
- Low Supply Current
- Minimum external components
- Micro-power shutdown
- Available in space-saving 16-bump μSMD package

Applications

- Mobile Phones
- PDAs
- Notebook PCs
- Portable Electronic Devices
- MP3 Players

Typical Application

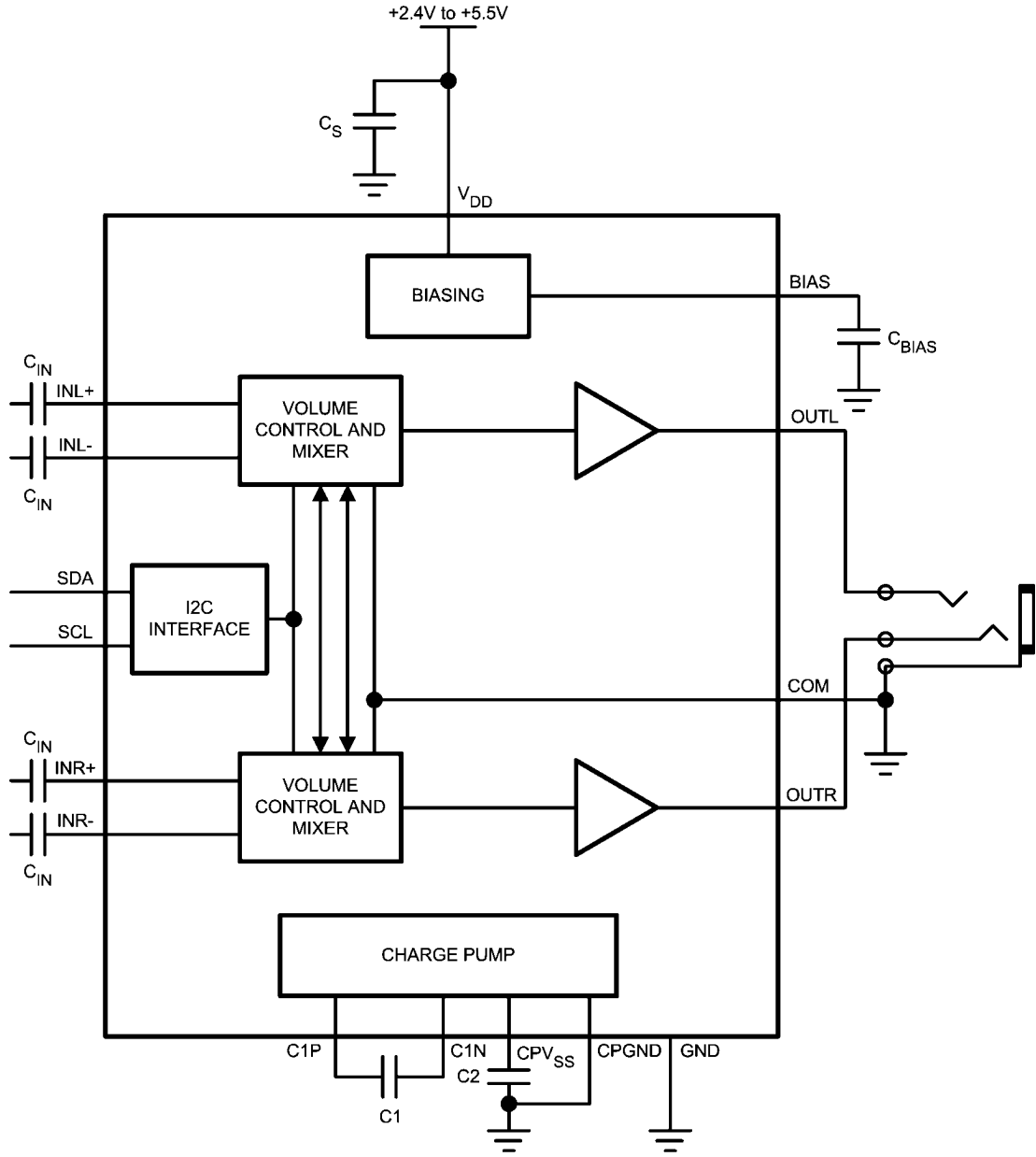

30061013

FIGURE 1. Typical Audio Amplifier Application Circuit

Connection Diagrams

TL Package
2mm x 2mm x 0.8mm

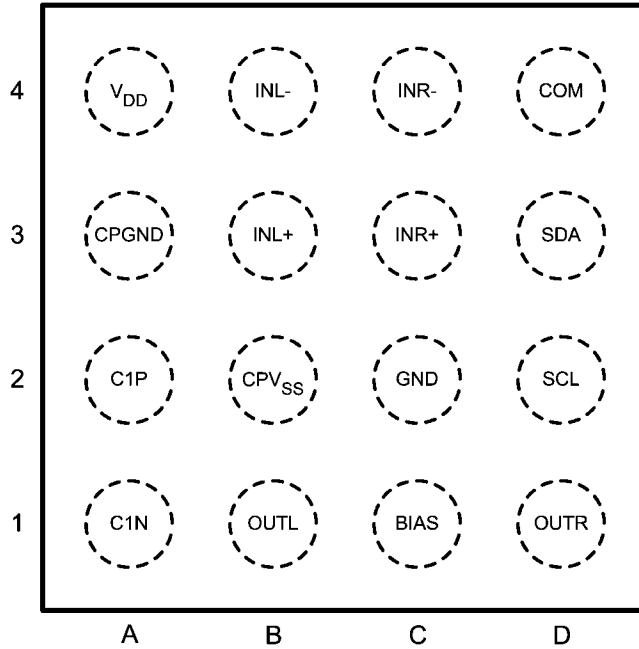

30061011

Top View
Order Number LM48822TL
See NS Package Number TLA1611A

16-Bump micro SMD Marking



Pin 1

30061017

Top View
XY = Date code
TT = Die traceability
G = Boomer Family
K1 = LM48822TL

Absolute Maximum Ratings (Note 1, Note 2)

If Military/Aerospace specified devices are required, please contact the National Semiconductor Sales Office/Distributors for availability and specifications.

Supply Voltage (Note 1)	6V
Storage Temperature	-65°C to +150°C
Input Voltage	-0.3V to $V_{DD} + 0.3V$
Power Dissipation (Note 3)	Internally Limited
ESD Rating (Note 4)	2000V
ESD Rating (Note 5)	150V

Junction Temperature	150°C
Thermal Resistance	
θ_{JA} TLA1611A	63°C/W
Soldering Information	
See AN-1112 "Micro SMD Wafer Level Chip Scale package"	

Operating Ratings

Temperature Range	
$T_{MIN} \leq T_A \leq T_{MAX}$	-40°C \leq T_A \leq +85°C
Supply Voltage (V_{DD})	2.4V \leq V_{DD} \leq 5.5V

Electrical Characteristics $V_{DD} = 3.6V$ (Note 1, Note 2)

The following specifications apply for $A_V = 0dB$, $R_L = 16\Omega$, $f = 1kHz$, unless otherwise specified. Limits apply to $T_A = 25^\circ C$.

Symbol	Parameter	Conditions	LM48822		Units (Limits)
			Typical (Note 6)	Limit (Note 7)	
I_{DD}	Quiescent Power Supply Current	$V_{IN} = 0V$, both channels active			
		$R_L = 16\Omega$	3.5	4.5	mA (max)
		$R_L = \infty$	3.5	4.5	mA (max)
I_{SD}	Shutdown Current	Shutdown Enabled	0.06	1.2	μA (max)
V_{OS}	Differential Output Offset Voltage	$V_{IN} = 0V$, $R_L = 16\Omega$	1	5	mV (max)
T_{WU}	Wake Up Time		200		μs
A_V	Voltage Gain	Minimum Gain Setting	-59.5	+0.5 -0.5	dB (max) dB (min)
		Maximum Gain Setting	3.8	+0.5 -0.5	dB (max) dB (min)
R_{IN}	Input Resistance	$A_V = 4dB$	25	30	k Ω (max)
		$A_V = -60dB$	60	70	k Ω (max)
P_O	Output Power	$R_L = 16\Omega$, $f = 1kHz$, THD+N = 1% Single channel	70		mW
		Two channels in phase	35	27	mW (min)
		$R_L = 32\Omega$, $f = 1kHz$, THD+N = 1% Single channel	65		mW
		Two channels in phase	40		mW
THD+N	Total Harmonic Distortion + Noise	$P_O = 50mW$, $f = 1kHz$, $R_L = 16\Omega$ single channel	0.04		%
		$P_O = 40mW$, $f = 1kHz$, $R_L = 32\Omega$ single channel	0.02		%
PSRR	Power Supply Rejection Ratio	$V_{RIPPLE} = 200mV_{P-P}$, Inputs AC GND $C_{IN} = 1\mu F$, input referred, $SD_BIAS = 0$ $f_{RIPPLE} = 217Hz$	110	100	dB (min)
		$f_{RIPPLE} = 1kHz$	100		dB
CMRR	Common Mode Rejection Ratio	$V_{RIPPLE} = 1V_{P-P}$	95		dB
X_{TALK}	Crosstalk	$R_L \geq 16\Omega$, $P_{OUT} = 1.6mW$, $f = 1kHz$	80	70	dB (min)
		$R_L \geq 10k\Omega$, $V_{OUT} = 1V_{RMS}$, $f = 1kHz$	95	85	dB (min)
SNR	Signal-to-Noise Ratio	$R_L = 16\Omega$, $f = 1kHz$	100		dB
ϵ_{OS}	Output Noise	$A_V = 4dB$, Input referred A-Weighted Filter	7		μV

Symbol	Parameter	Conditions	LM48822		Units (Limits)
			Typical (Note 6)	Limit (Note 7)	
R_{OUT}	Output Impedance	Charge pump-only mode enabled	40	25	k Ω (min)
V_{OUT}	Maximum Voltage Swing	Voltage applied to amplifier outputs in charge pump-only mode		2	V _{RMS} (min)

I²C Interface Characteristics $V_{DD} = 3.6V$ (Note 1, Note 2)

The following specifications apply for $A_V = 0dB$, $R_L = 16\Omega$, $f = 1kHz$, unless otherwise specified. Limits apply to $T_A = 25^\circ C$.

Symbol	Parameter	Conditions	LM48822		Units (Limits)
			Typical (Note 6)	Limit (Note 7)	
t_1	SCL Period			2.5	μs (min)
t_2	SDA Setup Time			100	ns (min)
t_3	SDA Stable Time			0	ns (min)
t_4	Start Condition Time			100	ns (min)
t_5	Stop Condition Time			100	ns (min)
V_{IH}	Input High Voltage			1.3	V (min)
V_{IL}	Input Low Voltage			0.4	V (max)

Note 1: "Absolute Maximum Ratings" indicate limits beyond which damage to the device may occur, including inoperability and degradation of device reliability and/or performance. Functional operation of the device and/or non-degradation at the Absolute Maximum Ratings or other conditions beyond those indicated in the Recommended Operating Conditions is not implied. The Recommended Operating Conditions indicate conditions at which the device is functional and the device should not be operated beyond such conditions. All voltages are measured with respect to the ground pin, unless otherwise specified.

Note 2: The Electrical Characteristics tables list guaranteed specifications under the listed Recommended Operating Conditions except as otherwise modified or specified by the Electrical Characteristics Conditions and/or Notes. Typical specifications are estimations only and are not guaranteed.

Note 3: maximum allowable power dissipation is $P_{DMAX} = (T_{JMAX} - T_A) / \theta_{JA}$ or the number given in Absolute Maximum Ratings, whichever is lower.

Note 4: Human body model, applicable std. JESD22-A114C.

Note 5: Machine model, applicable std. JESD22-A115-A.

Note 6: Typical values represent most likely parametric norms at $T_A = +25^\circ C$, and at the Recommended Operation Conditions at the time of product characterization and are not guaranteed.

Note 7: Datasheet min/max specification limits are guaranteed by test or statistical analysis.

Bump Descriptions

Pin	Name	Function
A1	C1N	Charge Pump Flying Capacitor Negative Terminal
A2	C1P	Charge Pump Flying Capacitor Positive Terminal
A3	CPGND	Charge Pump Ground
A4	V_{DD}	Power Supply
B1	OUTL	Left Channel Output
B2	CPV _{SS}	Charge Pump Output
B3	INL+	Left Channel Non-Inverting Input
B4	INL-	Left Channel Inverting Input
C1	BIAS	Bias Voltage Bypass
C2	GND	Ground
C3	INR+	Right Channel Non-Inverting Input
C4	INR-	Right Channel Inverting Input
D1	OUTR	Right Channel Output
D2	SCL	I ² C Serial Clock Input
D3	SDA	I ² C Serial Data Input
D4	COM	Common-Mode Sense Input

Typical Performance Characteristics

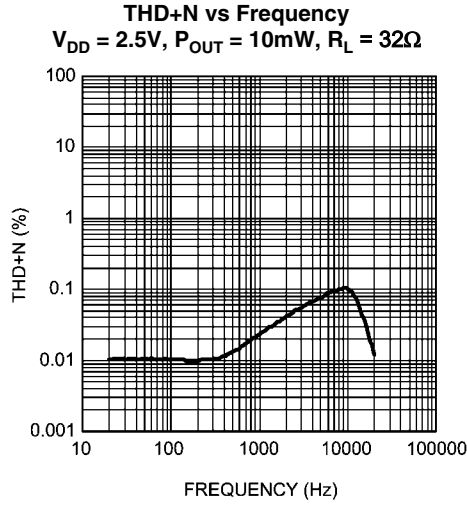

30061095

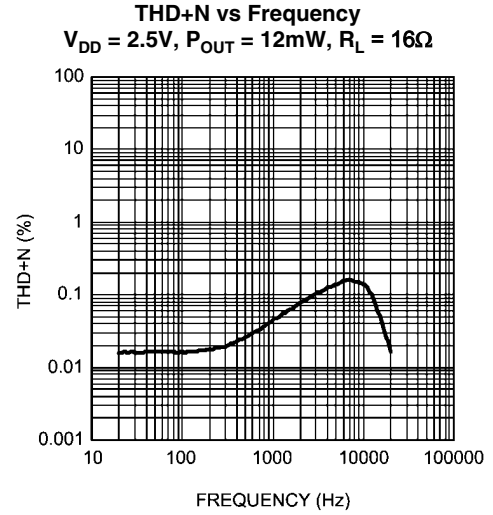

30061092

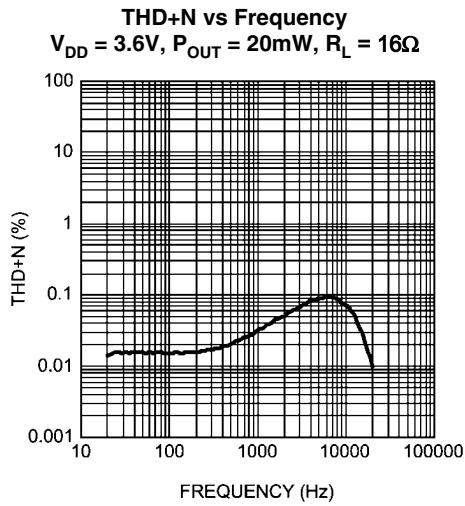

30061093

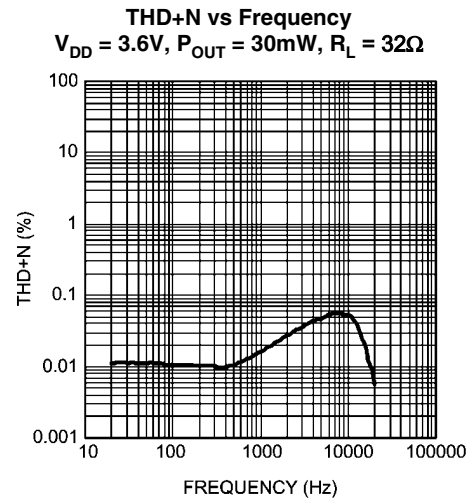

30061096

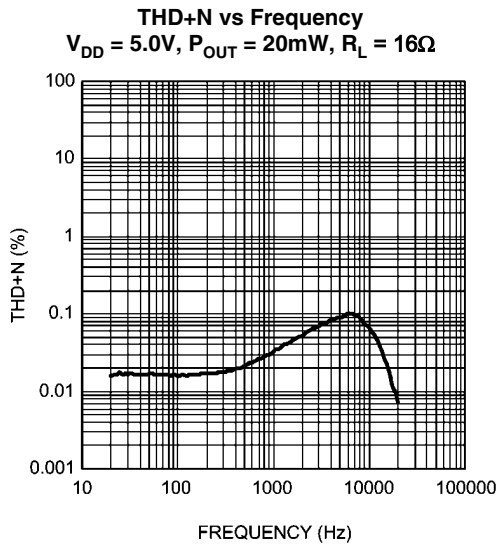

30061094

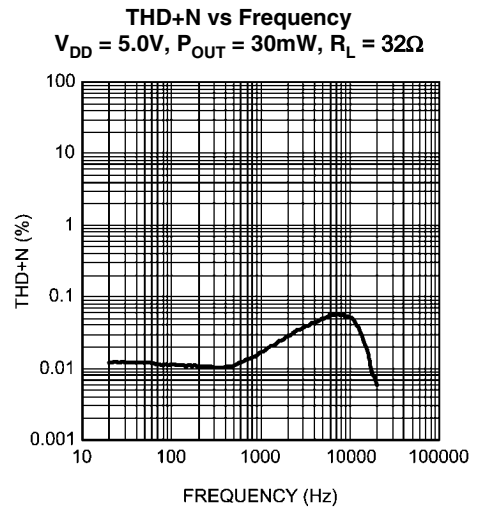

30061097

THD+N vs Output Power
 $A_V = 0\text{dB}$, $R_L = 16\Omega$, $f = 1\text{kHz}$
 Both Outputs in Phase

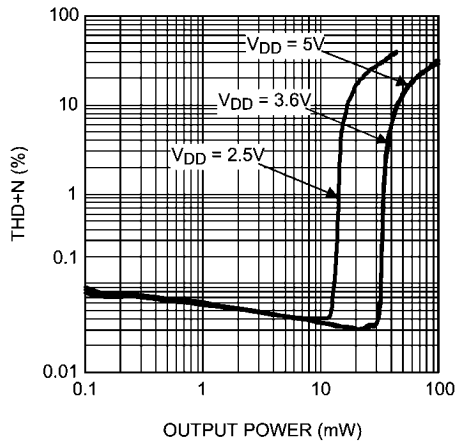

30061090

THD+N vs Output Power
 $A_V = 0\text{dB}$, $R_L = 32\Omega$, $f = 1\text{kHz}$
 Both Outputs in Phase

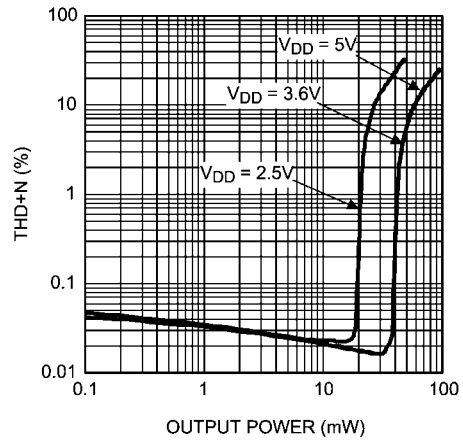

30061091

THD+N vs Output Power
 $A_V = 9\text{dB}$, $R_L = 16\Omega$, $f = 1\text{kHz}$
 Both Outputs in Phase

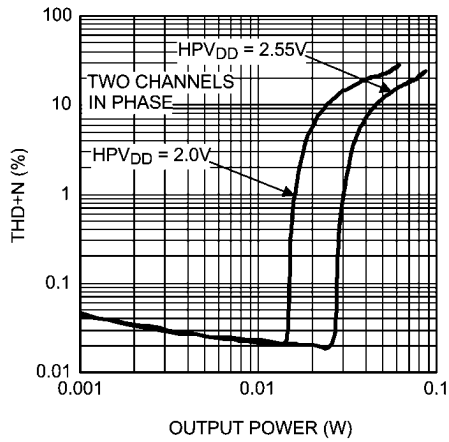

300610a7

Power Dissipation vs Output Power
 $R_L = 16\Omega$, $f = 1\text{kHz}$

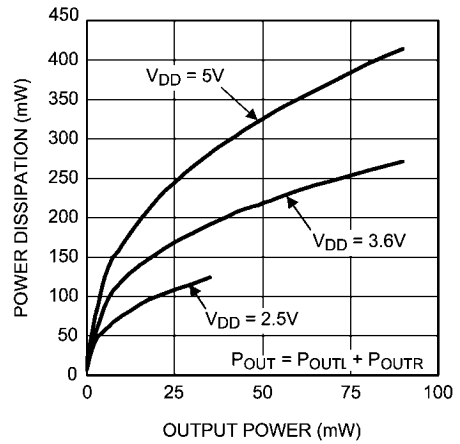

30061098

Power Dissipation vs Output Power
 $R_L = 32\Omega$, $f = 1\text{kHz}$

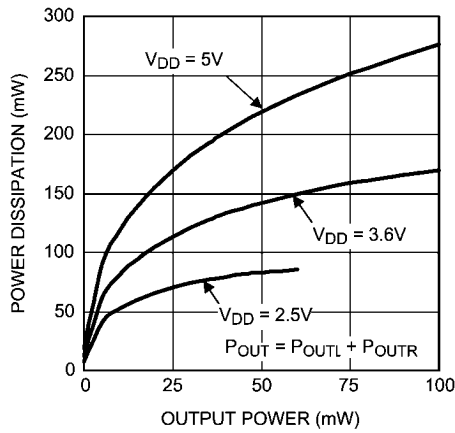

30061099

Output Power vs Supply Voltage
 $R_L = 16\Omega$, $f = 1\text{kHz}$

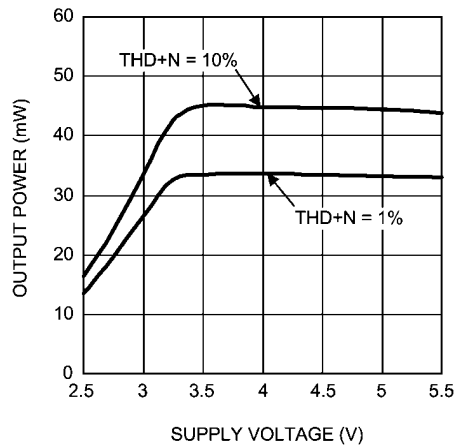

300610a0

Output Power vs Supply Voltage
 $R_L = 32\Omega, f = 1\text{kHz}$

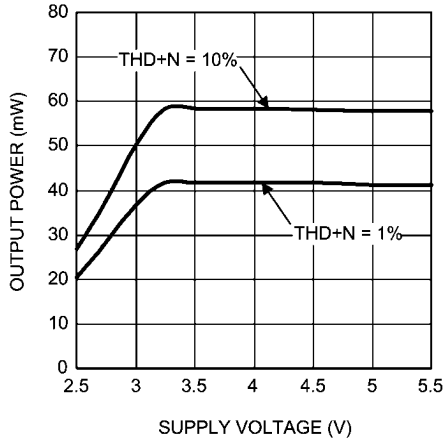

300610a1

CMRR vs Frequency
 $V_{DD} = 3.6\text{V}, V_{CM} = 1\text{V}_{p-p}, R_L = 32\Omega$

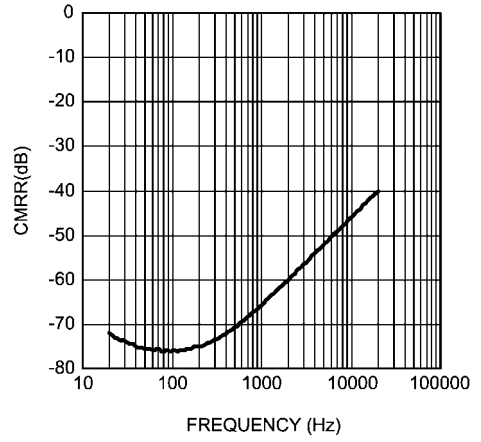

300610a3

PSRR vs Frequency
 $V_{DD} = 3.6\text{V}, V_{RIPPLE} = 20\text{mV}_{p-p}, R_L = 32\Omega$

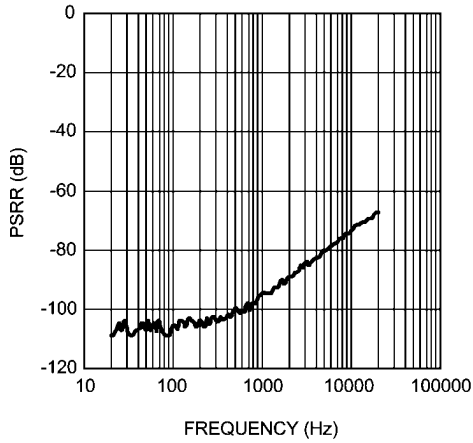

300610a2

Crosstalk vs Frequency
 $V_{DD} = 3.6\text{V}, V_{RIPPLE} = 1\text{V}_{p-p}, R_L = 32\Omega$

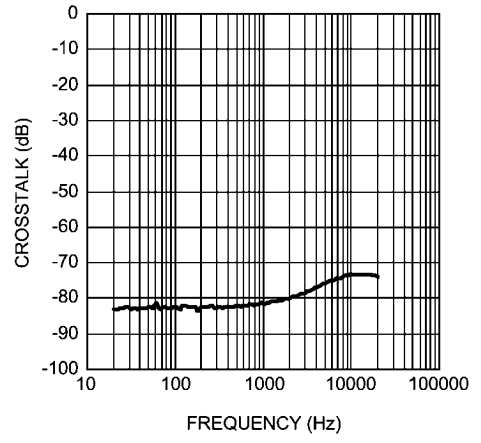

300610a4

Ground Noise vs Frequency
 $V_{DD} = 3.6\text{V}, V_{RIPPLE} = 20\text{mV}_{p-p}, R_L = 32\Omega$

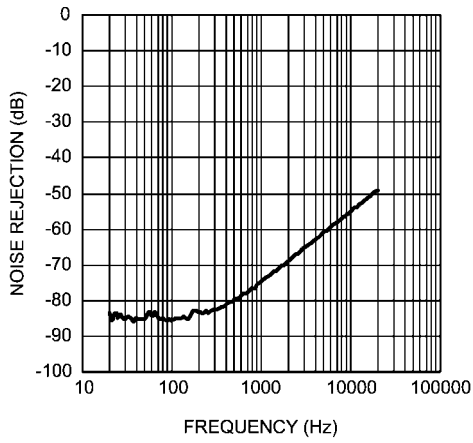

300610a5

Supply Current vs Supply Voltage
 No Load

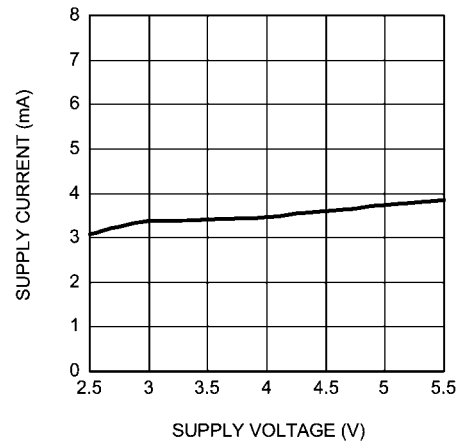

300610a6

Application Information

I²C COMPATIBLE INTERFACE

The LM48822 is controlled through an I²C compatible serial interface that consists of a serial data line (SDA) and a serial clock (SCL). The clock line is uni-directional. The data line is bi-directional (open collector). The LM48822 and the master can communicate at clock rates up to 400kHz. *Figure 2* shows the I²C interface timing diagram. Data on the SDA line must be stable during the HIGH period of SCL. The LM48822 is a transmit/receive slave-only device, reliant upon the master to generate the SCL signal. Each transmission sequence is framed by a START condition and a STOP condition *Figure 3*. Each data word, device address and data, transmitted over the bus is 8 bits long as is always followed by an acknowledge pulse (Figure 4). The LM48822 device address is 1100000.

I²C BUS FORMAT

The I²C bus format is shown in *Figure 4*. The START signal, the transition of SDA from HIGH to LOW while SDA is HIGH,

is generated, altering all devices on the bus that a device address is being written to the bus.

The 7-bit device address is written to the bus, most significant bit (MSB) first, followed by the R/W bit. R/W = 0 indicates the master is writing to the slave device, R/W = 1 indicates the master wants to read data from the slave device. The LM48822 is a WRITE-ONLY device and will not respond the R/W = 1. The data is latched in on the rising edge of the clock. Each address bit must be stable while SDA is HIGH. After the last address bit is transmitted, the master device releases SDA, during which time, an acknowledge clock pulse is generated by the slave device. If the LM48822 receives the correct address, the device pulls the SDA line low, generating an acknowledge bit (ACK).

Once the master device registers the ACK bit, the 8-bit register data word is sent. Each data bit should be stable while SCL is HIGH. After the 8-bit register data word is sent, the LM48822 sends another ACK bit. Following the acknowledgement of the register data word, the master issues a STOP bit, allowing SDA to go high while SDA is high.

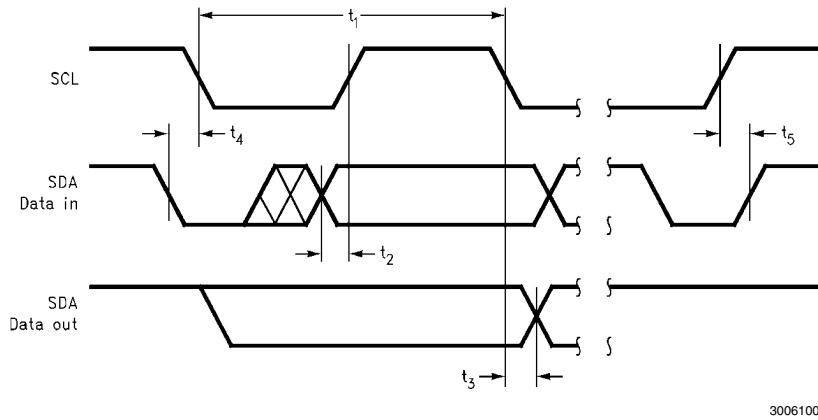

FIGURE 2. I²C Timing Diagram

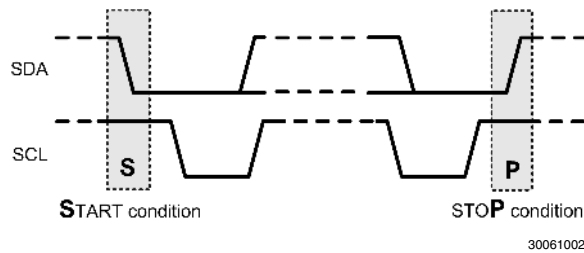

FIGURE 3. Start and Stop Diagram

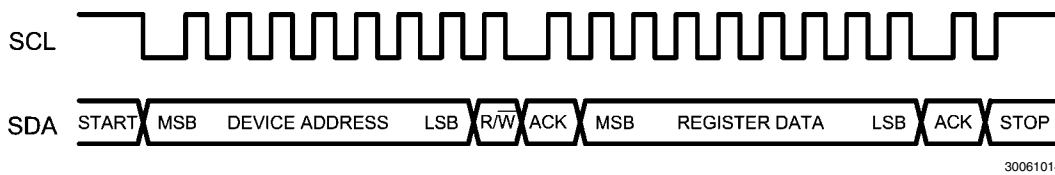

FIGURE 4. Example I²C Write Cycle

TABLE 1. Device Address

	B7	B6	B5	B4	B3	B2	B1	B0 (R/W)
Device Address	1	1	0	0	0	0	0	0

TABLE 2. I²C Control Registers

Register Address	Register Name	B7	B6	B5	B4	B3	B2	B1	B0
0	MODE CONTROL	0	SDL	SD_BIAS	CP_ONLY	0	MUTE_LEFT	SDR	MUTE_RIGHT
1	VOLUME CONTROL	1	SHDN	VOL5	VOL4	VOL3	VOL2	VOL1	VOL0

TABLE 3. Mode Control Register

Bit	Name	Value	Description
B6	SDL	0	Left channel enabled
		1	Left channel disabled
B5	SD_BIAS	0	Bias enabled
		1	Bias disabled
B4	CP_ONLY	0	Normal operation
		1	Charge-pump only mode. Amplifiers and Bias disabled.
B3	UNUSED	0	Set B3 to 0
B2	MUTE_LEFT	0	Left channel Normal Operation
		1	Left channel Mute
B1	SDR	0	Right channel enabled
		1	Right channel disabled. Right channel audio inputs summed with left channel audio inputs and routed to OUTL
B0	MUTE_RIGHT	0	Right channel Normal Operation
		1	Right channel Mute

GENERAL AMPLIFIER FUNCTION

The LM48822 headphone amplifier feature National's ground referenced architecture that eliminates the large DC-blocking capacitors required at the outputs of traditional headphone amplifiers. A low-noise inverting charge pump creates a negative supply (CPV_{SS}) from the positive supply voltage (V_{DD}). The headphone amplifiers operate from these bipolar supplies, with the amplifier outputs biased about GND, instead of a nominal DC voltage (typically V_{DD}/2), like traditional amplifiers. Because there is no DC component to the headphone output signals, the large DC-blocking capacitors (typically 220μF) are not necessary, conserving board space and system cost, while improving frequency response.

GENERAL AMPLIFIER EXPLANATION

The LM48822 features a differential input stage, which offers improved noise rejection compared to a single-ended input amplifier. Because a differential input amplifier amplifies the difference between the two input signals, any component common to both signals is cancelled. An additional benefit of the differential input structure is the possible elimination of the DC input blocking capacitors. Since the DC component is common to both inputs, and thus cancelled by the amplifier, the LM48822 can be used without input coupling capacitors when configured with a differential input signal.

CHARGE PUMP ONLY MODE

In applications where the headphone jack is used as both an output and input port, signals such as a microphone input can appear on the headphone amplifier output. Traditional charge pump headphone amplifiers can clamp or distort the signals that appear on their output. Without the charge pump active, generating the negative voltage supply, the internal protection diodes of the amplifier clamp the incoming signal, distorting the negative half cycle, see Figure 5. The LM48822 charge pump only mode eliminates this problem. In charge pump only mode, the amplifiers are disabled, while the charge pump remains active. The disabled amplifier outputs present a high impedance (1MΩ) load to the incoming signal. The charge pump maintains the negative rail, allowing the incoming signal to swing between V_{DD} and V_{SS} without any interference from the device.

Set bit B4 (CP_ONLY) of the MODE CONTROL register to 1 for charge pump only mode. Setting CP_ONLY = 1 disables both the left and right channels, regardless of the status of the shutdown control bits. Set CP_ONLY = 0 for normal operation.

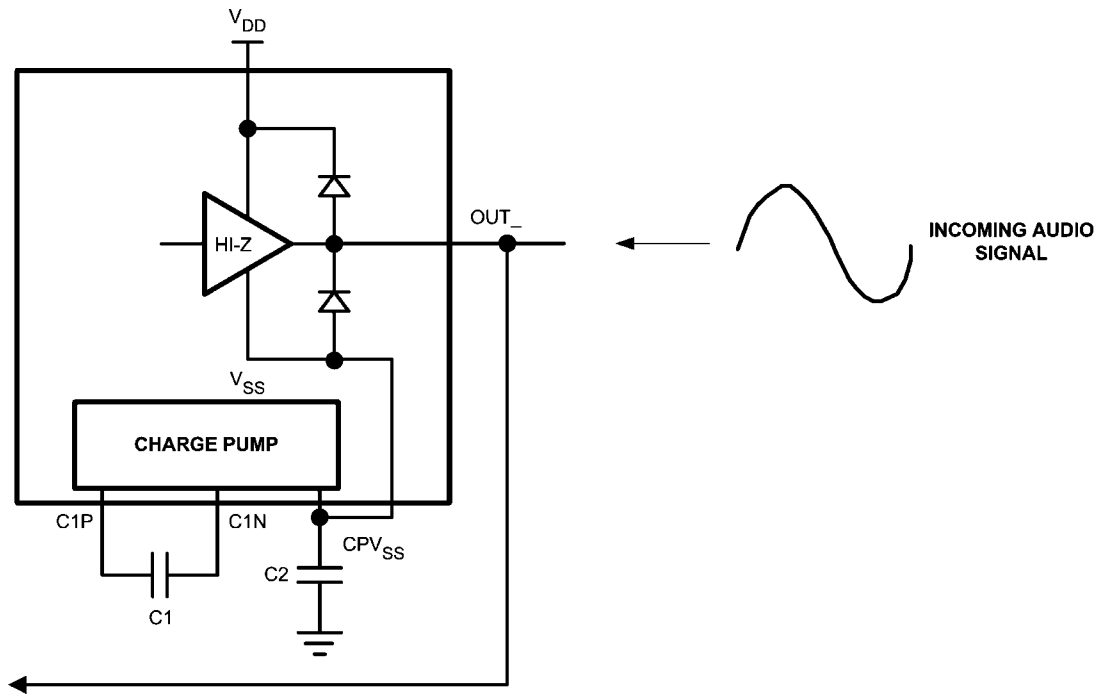

30061015

FIGURE 5. Back-Driving the LM48822 Outputs

COMMON MODE SENSE

The LM48822 features a ground (common mode) sensing feature. In noisy applications, or where the headphone jack is used as a line out to other devices, noise pick up and ground imbalance can degrade audio quality. The LM48822 COM input senses and corrects any noise at the headphone return,

or any ground imbalance between the headphone return and device ground, improving audio reproduction. Connect COM directly to the headphone return terminal of the headphone jack *Figure 6*. No additional external components are required. Connect COM to GND if the common-mode sense feature is not in use.

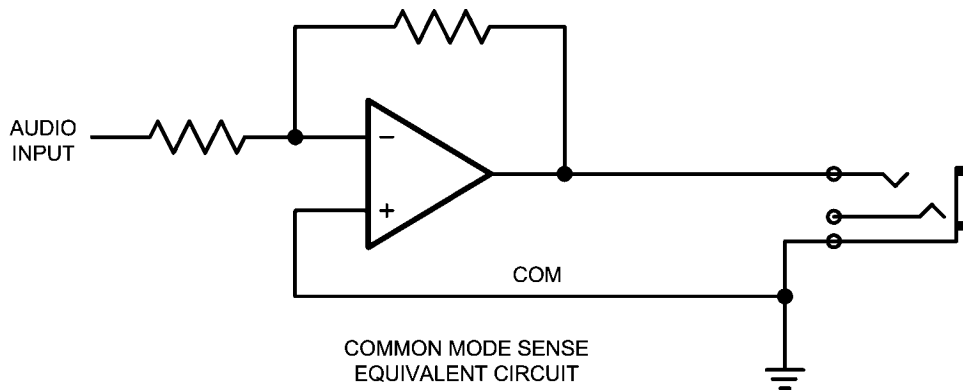

30061016

FIGURE 6. COM Connection Example

VOLUME CONTROL

Volume Control Table

VOLUME STEP	VOL5	VOL4	VOL3	VOL2	VOL1	VOL0	HP GAIN (dB)
1	0	0	0	0	0	0	-96
2	0	0	0	0	0	1	-60
3	0	0	0	0	1	0	-57
4	0	0	0	0	1	1	-54
5	0	0	0	1	0	0	-51
6	0	0	0	1	0	1	-48
7	0	0	0	1	1	0	-45
8	0	0	0	1	1	1	-42
9	0	0	1	0	0	0	-39
10	0	0	1	0	0	1	-36
11	0	0	1	0	1	0	-34.5
12	0	0	1	0	1	1	-33
13	0	0	1	1	0	0	-31.5
14	0	0	1	1	0	1	-30
15	0	0	1	1	1	0	-28.5
16	0	0	1	1	1	1	-27
17	0	1	0	0	0	0	-25.5
18	0	1	0	0	0	1	-24
19	0	1	0	0	1	0	-22.5
20	0	1	0	0	1	1	-21
21	0	1	0	1	0	0	-19.5
22	0	1	0	1	0	1	-18
23	0	1	0	1	1	0	-16.5
24	0	1	0	1	1	1	-16
25	0	1	1	0	0	0	-15.5
26	0	1	1	0	0	1	-15
27	0	1	1	0	1	0	-14.5
28	0	1	1	0	1	1	-14
29	0	1	1	1	0	0	-13.5
30	0	1	1	1	0	1	-13
31	0	1	1	1	1	0	-12.5
32	0	1	1	1	1	1	-12
33	1	0	0	0	0	0	-11.5
34	1	0	0	0	0	1	-11
35	1	0	0	0	1	0	-10.5
36	1	0	0	0	1	1	-10
37	1	0	0	1	0	0	-9.5
38	1	0	0	1	0	1	-9
39	1	0	0	1	1	0	-8.5
40	1	0	0	1	1	1	-8
41	1	0	1	0	0	0	-7.5
42	1	0	1	0	0	1	-7
43	1	0	1	0	1	0	-6.5
44	1	0	1	0	1	1	-6
45	1	0	1	1	0	0	-5.5
46	1	0	1	1	0	1	-5
47	1	0	1	1	1	0	-4.5

VOLUME STEP	VOL5	VOL4	VOL3	VOL2	VOL1	VOL0	HP GAIN (dB)
48	1	0	1	1	1	1	-4
49	1	1	0	0	0	0	-3.5
50	1	1	0	0	0	1	-3
51	1	1	0	0	1	0	-2.5
52	1	1	0	0	1	1	-2
53	1	1	0	1	0	0	-1.5
54	1	1	0	1	0	1	-1
55	1	1	0	1	1	0	-0.5
56	1	1	0	1	1	1	0
57	1	1	1	0	0	0	0.5
58	1	1	1	0	0	1	1
59	1	1	1	0	1	0	1.5
60	1	1	1	0	1	1	2
61	1	1	1	1	0	0	2.5
62	1	1	1	1	0	1	3
63	1	1	1	1	1	0	3.5
64	1	1	1	1	1	1	4

SHUTDOWN FUNCTION

The LM48822 features three shutdown controls. Bits B6 (SDL) and B1 (SDR) of the MODE CONTROL register control the left and right channels, respectively. Set the control bits to 1 to disable the corresponding channel. When SDR = 1 and SDL = 0, the right channel is disabled, the right and left inputs are summed and output as a mono signal on the OUTL. When SDL = 1 and SDR = 0, the left channel is disabled, while only the right input signal is output on OUTR. Setting both SDL and SDR = 1 disables both channels, while the charge pump remains active. Bit B6 (SHDN) of the VOLUME CONTROL register is the global shutdown control for the entire device. Set SHDN = 1 to disable the entire device; both amplifiers and charge pump are disabled. Set SHDN = 0 for normal operation. SHDN = 1 overrides any other shutdown control bit.

MUTE FUNCTION

Set bits B2 (MUTE_LEFT) and B0 (MUTE_RIGHT) of the MODE CONTROL register to 1 to mute the respective channels. Set MUTE_LEFT and MUTE_RIGHT to 0 for normal operation.

SD_BIAS FUNCTION

The LM48822 BIAS is controlled through the I²C interface. Set bit B5 (SD_BIAS) of the MODE CONTROL register to 1 to enable the LM48822 BIAS. BIAS provides the voltage for both the amplifiers and the charge pump. When enabled, V_{BIAS} will track V_{DD} for V_{DD} < 3V. Once V_{DD} exceeds 3V, V_{BIAS} remains fixed at 3V, limiting the output swing of the device the 6V_{P-P}. Set SD_BIAS = 0 to disable BIAS. Disabling BIAS allows the amplifier and charge pump to track V_{DD}, increasing output swing; however, a slight degradation in PSSR will occur. Limit V_{DD} to 4.2V or less when BIAS is disabled.

PROPER SELECTION OF EXTERNAL COMPONENTS

Power Supply Bypassing/Filtering

Proper power supply bypassing is critical for low noise performance and high PSRR. Place the supply bypass capacitors as close to the supply pins as possible. Place a 1μF ceramic capacitors from V_{DD} to GND. Additional bulk capacitance may be added as required.

Charge Pump Capacitor Selection

Use low ESR ceramic capacitors (less than 100mΩ) for optimum performance.

Charge Pump Flying Capacitor (C1)

The flying capacitor (C1) affects the load regulation and output impedance of the charge pump. A C1 value that is too low results in a loss of current drive, leading to a loss of amplifier headroom. A higher valued C1 improves load regulation and lowers charge pump output impedance to an extent. Above 2.2μF, the R_{DS(ON)} of the charge pump switches and the ESR of C1 and C2 dominate the output impedance. A lower value capacitor can be used in systems with low maximum output power requirements.

Charge Pump Flying Capacitor (C2)

The value and ESR of the hold capacitor (C2) directly affects the ripple on CPV_{SS}. Increasing the value of C2 reduces output ripple. Decreasing the ESR of C2 reduces both output ripple and charge pump output impedance. A lower value capacitor can be used in systems with low maximum output power requirements.

Input Capacitor Selection

Input capacitors may be required for some applications, or when the audio source is single-ended. Input capacitors block the DC component of the audio signal, eliminating any conflict between the DC component of the audio source and the bias voltage of the LM48822. The input capacitors create a high-pass filter with the input resistors R_{IN}. The -3dB point of the high pass filter is found using Equation 1 below.

$$f = 1 / 2\pi R_{IN} C_{IN} \quad (\text{Hz}) \quad (1)$$

Where the value of R_{IN} is given in the Electrical Characteristics Table.

High pass filtering the audio signal helps protect the speakers. When the LM48822 is using a single-ended source, power supply noise on the ground is seen as an input signal. Setting the high-pass filter point above the power supply noise frequencies, 217Hz in a GSM phone, for example, filters out the noise such that it is not amplified and heard on the output. Capacitors with a tolerance of 10% or better are recommended for impedance matching and improved CMRR and PSRR.

SINGLE-ENDED AUDIO AMPLIFIER CONFIGURATION

The LM48822 is compatible with single-ended sources. Figure 7 shows the typical single-ended applications circuit.

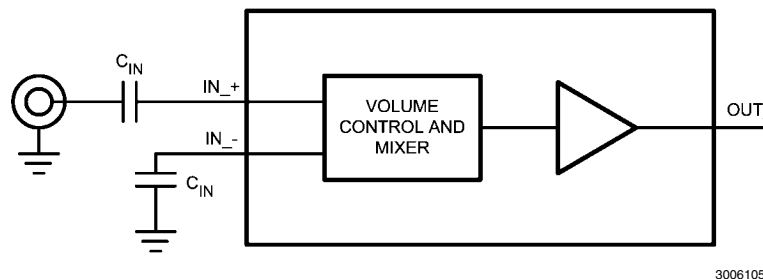

FIGURE 7. Single-Ended Input Configuration

PCB LAYOUT CONFIGURATION

Minimize trace impedance of the power, ground and all output traces for optimum performance. Voltage loss due to trace resistance between the LM48822 and the load results in decreased output power and efficiency. Trace resistance between the power supply and ground has the same effect as a poorly regulated supply, increased ripple and reduced peak output power. Use wide traces for power supply inputs and amplifier outputs to minimize losses due to trace resistance, as well as route heat away from the device. Proper grounding

improves audio performance, minimizes crosstalk between channels and prevents switching noise from interfering with the audio signal. Use of power and ground planes is recommended.

Place all digital components and route digital signal traces as far as possible from analog components and traces. Do not run digital and analog traces in parallel on the same PCB layer. If digital and analog signal lines must cross either over or under each other, ensure that they cross in a perpendicular fashion.

LM48822TL Demoboard of Materials

TABLE 4. LM48822TL Demoboard Bill of Materials

Designator	Quantity	Description
C1	1	10 μ F \pm 10% 16V 500 Ω Tantalum Capacitor (B Case) AVX TPSB106K016R0500
C2	1	1 μ F \pm 10% 16V X5R Ceramic Capacitor (603) Panasonic ECJ-1VB1C105K
C3, C8, C9	3	2.2 μ F \pm 10% 10V X5R Ceramic Capacitor (603) Panasonic ECJ-1VB1A225K
C4 — C7	4	1 μ F \pm 10% 16V X7R Ceramic Capacitor (1206) Panasonic ECJ-3YB1C105K
R1, R2	2	5k Ω \pm 5% 1/10W Thick Film Resistor (603) Vishay CRCW06035R1KJNEA
J1	1	Stereo Headphone Jack
J2	1	16-Pin Boardmount Socket 3M 8516-4500JL
JU1	1	3 Pin Header
JU2	1	2 Pin Header
LM48822TL	1	LM48822TL (16-Bump microSMD)

Demoboard Schematic

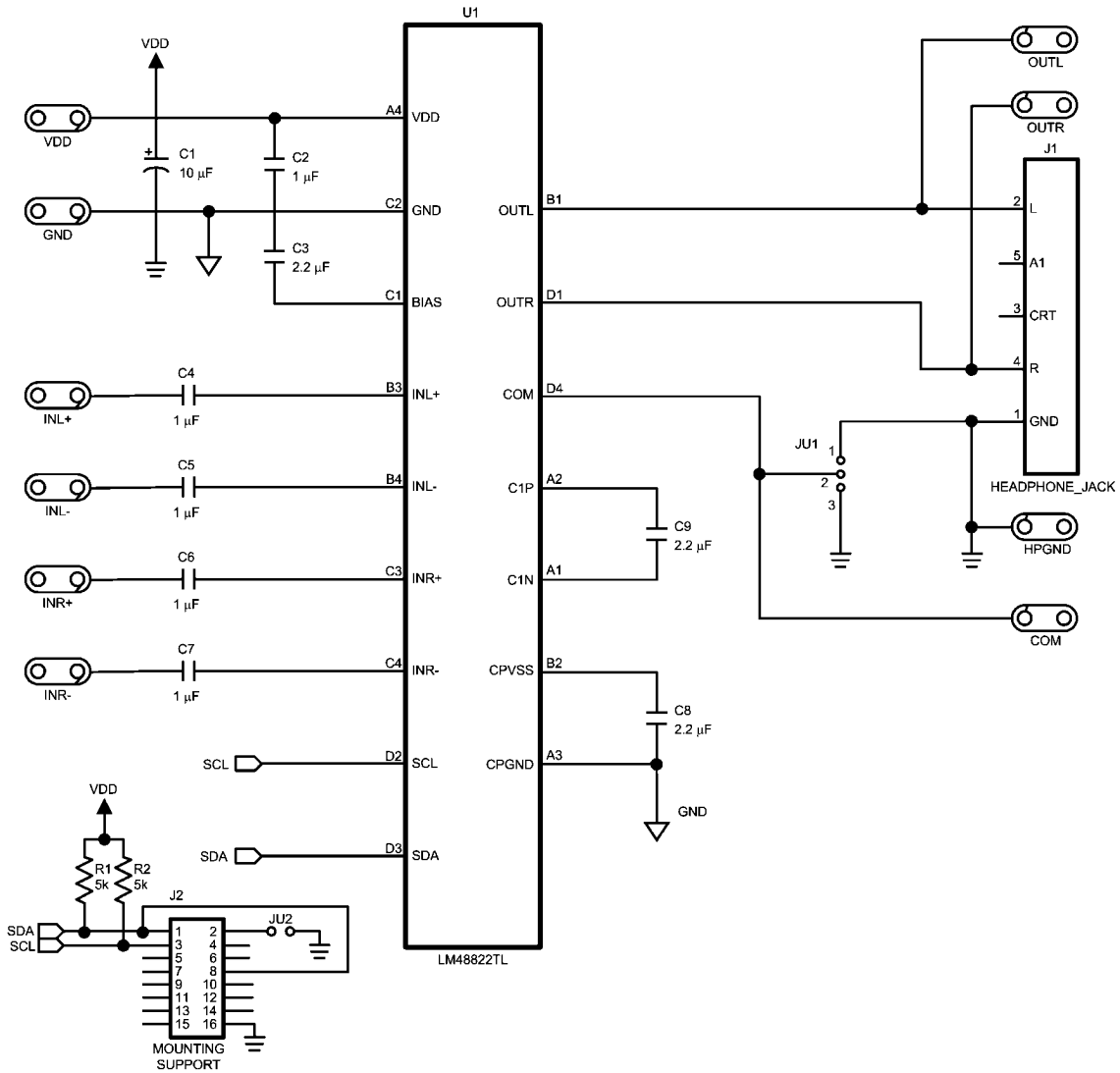

FIGURE 8. LM48822 Demoboard Schematic

30061057

Demonstration Board PCB Layout

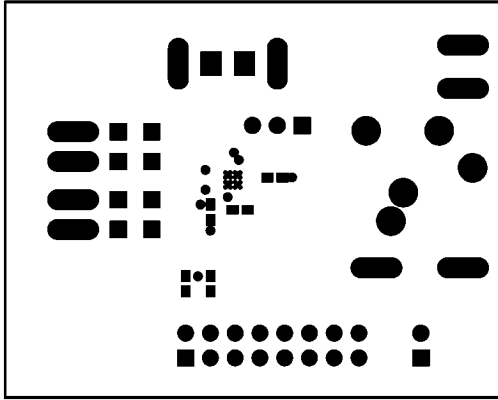

FIGURE 9. Solder Mask

30061066

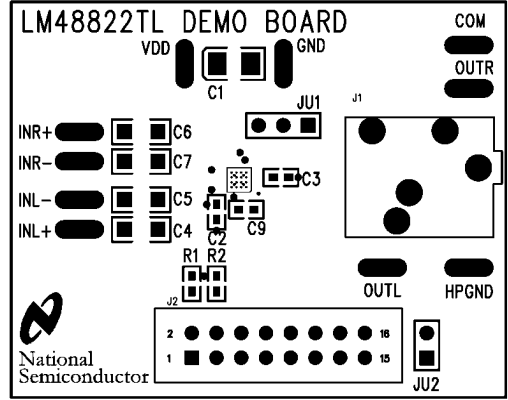

FIGURE 10. Top Silkscreen

30061068

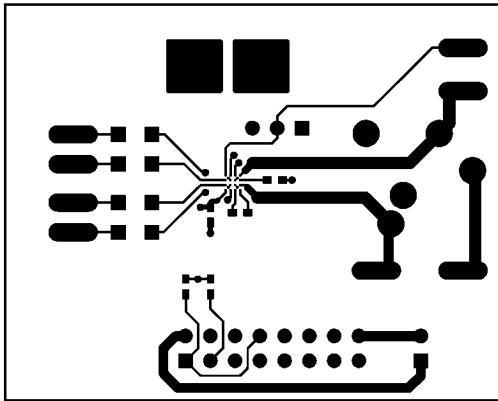

FIGURE 11. Top Layer

30061067

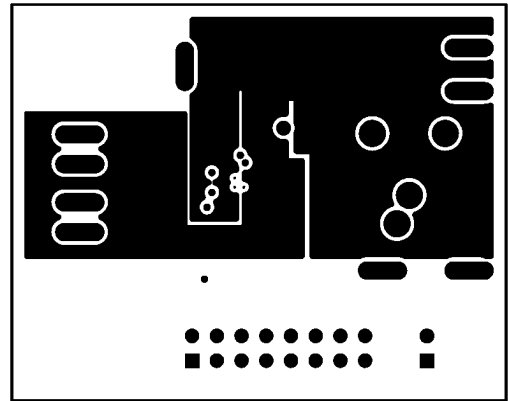

FIGURE 12. Layer 2 (GND)

30061062

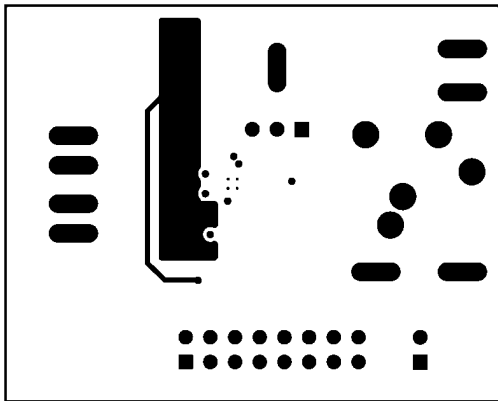

FIGURE 13. Layer 3 (V_{DD})

30061064

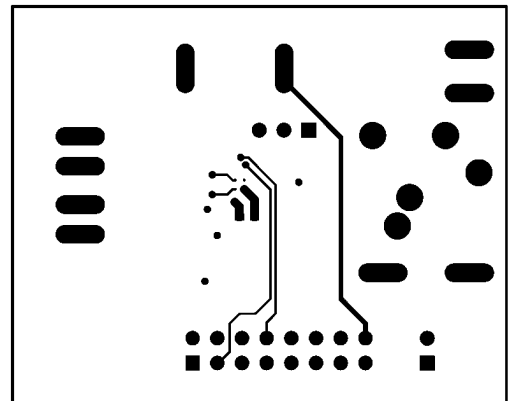
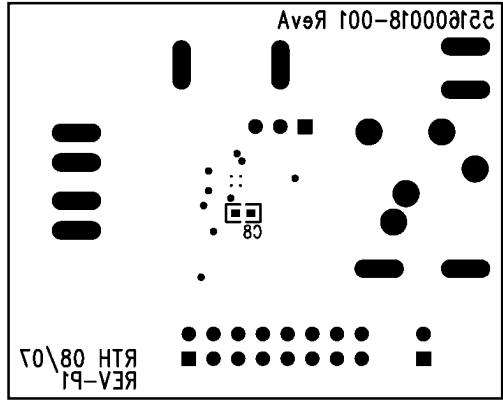

FIGURE 14. Bottom Layer

30061058



30061060

FIGURE 15. Bottom Silkscreen

Revision History

Rev	Date	Description
0.1	04/15/08	Initial PDF.
0.2	04/23/08	Added the demo boards and schematic.
0.3	04/30/08	Text edits.
0.4	07/10/08	Text edits.
0.5	03/09/11	Changed the bit B7 into B6 under the SHUTDOWN FUNCTION section.

Notes

For more National Semiconductor product information and proven design tools, visit the following Web sites at:
www.national.com

Products		Design Support	
Amplifiers	www.national.com/amplifiers	WEBENCH® Tools	www.national.com/webench
Audio	www.national.com/audio	App Notes	www.national.com/appnotes
Clock and Timing	www.national.com/timing	Reference Designs	www.national.com/refdesigns
Data Converters	www.national.com/adc	Samples	www.national.com/samples
Interface	www.national.com/interface	Eval Boards	www.national.com/evalboards
LVDS	www.national.com/lvds	Packaging	www.national.com/packaging
Power Management	www.national.com/power	Green Compliance	www.national.com/quality/green
Switching Regulators	www.national.com/switchers	Distributors	www.national.com/contacts
LDOs	www.national.com/ldo	Quality and Reliability	www.national.com/quality
LED Lighting	www.national.com/led	Feedback/Support	www.national.com/feedback
Voltage References	www.national.com/vref	Design Made Easy	www.national.com/easy
PowerWise® Solutions	www.national.com/powerwise	Applications & Markets	www.national.com/solutions
Serial Digital Interface (SDI)	www.national.com/sdi	Mil/Aero	www.national.com/milaero
Temperature Sensors	www.national.com/tempensors	SolarMagic™	www.national.com/solarmagic
PLL/VCO	www.national.com/wireless	PowerWise® Design University	www.national.com/training

THE CONTENTS OF THIS DOCUMENT ARE PROVIDED IN CONNECTION WITH NATIONAL SEMICONDUCTOR CORPORATION ("NATIONAL") PRODUCTS. NATIONAL MAKES NO REPRESENTATIONS OR WARRANTIES WITH RESPECT TO THE ACCURACY OR COMPLETENESS OF THE CONTENTS OF THIS PUBLICATION AND RESERVES THE RIGHT TO MAKE CHANGES TO SPECIFICATIONS AND PRODUCT DESCRIPTIONS AT ANY TIME WITHOUT NOTICE. NO LICENSE, WHETHER EXPRESS, IMPLIED, ARISING BY ESTOPPEL OR OTHERWISE, TO ANY INTELLECTUAL PROPERTY RIGHTS IS GRANTED BY THIS DOCUMENT.

TESTING AND OTHER QUALITY CONTROLS ARE USED TO THE EXTENT NATIONAL DEEMS NECESSARY TO SUPPORT NATIONAL'S PRODUCT WARRANTY. EXCEPT WHERE MANDATED BY GOVERNMENT REQUIREMENTS, TESTING OF ALL PARAMETERS OF EACH PRODUCT IS NOT NECESSARILY PERFORMED. NATIONAL ASSUMES NO LIABILITY FOR APPLICATIONS ASSISTANCE OR BUYER PRODUCT DESIGN. BUYERS ARE RESPONSIBLE FOR THEIR PRODUCTS AND APPLICATIONS USING NATIONAL COMPONENTS. PRIOR TO USING OR DISTRIBUTING ANY PRODUCTS THAT INCLUDE NATIONAL COMPONENTS, BUYERS SHOULD PROVIDE ADEQUATE DESIGN, TESTING AND OPERATING SAFEGUARDS.

EXCEPT AS PROVIDED IN NATIONAL'S TERMS AND CONDITIONS OF SALE FOR SUCH PRODUCTS, NATIONAL ASSUMES NO LIABILITY WHATSOEVER, AND NATIONAL DISCLAIMS ANY EXPRESS OR IMPLIED WARRANTY RELATING TO THE SALE AND/OR USE OF NATIONAL PRODUCTS INCLUDING LIABILITY OR WARRANTIES RELATING TO FITNESS FOR A PARTICULAR PURPOSE, MERCHANTABILITY, OR INFRINGEMENT OF ANY PATENT, COPYRIGHT OR OTHER INTELLECTUAL PROPERTY RIGHT.

LIFE SUPPORT POLICY

NATIONAL'S PRODUCTS ARE NOT AUTHORIZED FOR USE AS CRITICAL COMPONENTS IN LIFE SUPPORT DEVICES OR SYSTEMS WITHOUT THE EXPRESS PRIOR WRITTEN APPROVAL OF THE CHIEF EXECUTIVE OFFICER AND GENERAL COUNSEL OF NATIONAL SEMICONDUCTOR CORPORATION. As used herein:

Life support devices or systems are devices which (a) are intended for surgical implant into the body, or (b) support or sustain life and whose failure to perform when properly used in accordance with instructions for use provided in the labeling can be reasonably expected to result in a significant injury to the user. A critical component is any component in a life support device or system whose failure to perform can be reasonably expected to cause the failure of the life support device or system or to affect its safety or effectiveness.

National Semiconductor and the National Semiconductor logo are registered trademarks of National Semiconductor Corporation. All other brand or product names may be trademarks or registered trademarks of their respective holders.

Copyright© 2010 National Semiconductor Corporation

For the most current product information visit us at www.national.com



National Semiconductor Americas Technical Support Center
 Email: support@nsc.com
 Tel: 1-800-272-9959

National Semiconductor Europe Technical Support Center
 Email: europe.support@nsc.com

National Semiconductor Asia Pacific Technical Support Center
 Email: ap.support@nsc.com

National Semiconductor Japan Technical Support Center
 Email: jpn.feedback@nsc.com

IMPORTANT NOTICE

Texas Instruments Incorporated and its subsidiaries (TI) reserve the right to make corrections, modifications, enhancements, improvements, and other changes to its products and services at any time and to discontinue any product or service without notice. Customers should obtain the latest relevant information before placing orders and should verify that such information is current and complete. All products are sold subject to TI's terms and conditions of sale supplied at the time of order acknowledgment.

TI warrants performance of its hardware products to the specifications applicable at the time of sale in accordance with TI's standard warranty. Testing and other quality control techniques are used to the extent TI deems necessary to support this warranty. Except where mandated by government requirements, testing of all parameters of each product is not necessarily performed.

TI assumes no liability for applications assistance or customer product design. Customers are responsible for their products and applications using TI components. To minimize the risks associated with customer products and applications, customers should provide adequate design and operating safeguards.

TI does not warrant or represent that any license, either express or implied, is granted under any TI patent right, copyright, mask work right, or other TI intellectual property right relating to any combination, machine, or process in which TI products or services are used. Information published by TI regarding third-party products or services does not constitute a license from TI to use such products or services or a warranty or endorsement thereof. Use of such information may require a license from a third party under the patents or other intellectual property of the third party, or a license from TI under the patents or other intellectual property of TI.

Reproduction of TI information in TI data books or data sheets is permissible only if reproduction is without alteration and is accompanied by all associated warranties, conditions, limitations, and notices. Reproduction of this information with alteration is an unfair and deceptive business practice. TI is not responsible or liable for such altered documentation. Information of third parties may be subject to additional restrictions.

Resale of TI products or services with statements different from or beyond the parameters stated by TI for that product or service voids all express and any implied warranties for the associated TI product or service and is an unfair and deceptive business practice. TI is not responsible or liable for any such statements.

TI products are not authorized for use in safety-critical applications (such as life support) where a failure of the TI product would reasonably be expected to cause severe personal injury or death, unless officers of the parties have executed an agreement specifically governing such use. Buyers represent that they have all necessary expertise in the safety and regulatory ramifications of their applications, and acknowledge and agree that they are solely responsible for all legal, regulatory and safety-related requirements concerning their products and any use of TI products in such safety-critical applications, notwithstanding any applications-related information or support that may be provided by TI. Further, Buyers must fully indemnify TI and its representatives against any damages arising out of the use of TI products in such safety-critical applications.

TI products are neither designed nor intended for use in military/aerospace applications or environments unless the TI products are specifically designated by TI as military-grade or "enhanced plastic." Only products designated by TI as military-grade meet military specifications. Buyers acknowledge and agree that any such use of TI products which TI has not designated as military-grade is solely at the Buyer's risk, and that they are solely responsible for compliance with all legal and regulatory requirements in connection with such use.

TI products are neither designed nor intended for use in automotive applications or environments unless the specific TI products are designated by TI as compliant with ISO/TS 16949 requirements. Buyers acknowledge and agree that, if they use any non-designated products in automotive applications, TI will not be responsible for any failure to meet such requirements.

Following are URLs where you can obtain information on other Texas Instruments products and application solutions:

Products

Audio	www.ti.com/audio
Amplifiers	amplifier.ti.com
Data Converters	dataconverter.ti.com
DLP® Products	www.dlp.com
DSP	dsp.ti.com
Clocks and Timers	www.ti.com/clocks
Interface	interface.ti.com
Logic	logic.ti.com
Power Mgmt	power.ti.com
Microcontrollers	microcontroller.ti.com
RFID	www.ti-rfid.com
OMAP Mobile Processors	www.ti.com/omap
Wireless Connectivity	www.ti.com/wirelessconnectivity

Applications

Communications and Telecom	www.ti.com/communications
Computers and Peripherals	www.ti.com/computers
Consumer Electronics	www.ti.com/consumer-apps
Energy and Lighting	www.ti.com/energy
Industrial	www.ti.com/industrial
Medical	www.ti.com/medical
Security	www.ti.com/security
Space, Avionics and Defense	www.ti.com/space-avionics-defense
Transportation and Automotive	www.ti.com/automotive
Video and Imaging	www.ti.com/video

TI E2E Community Home Page

e2e.ti.com

Mailing Address: Texas Instruments, Post Office Box 655303, Dallas, Texas 75265
Copyright © 2011, Texas Instruments Incorporated