

**FASTON 187**

TE Internal #: 60487-2

TE Internal Description: 187 FASTON REC 18-16 AWG TPBR

[View on TE.com >](#)

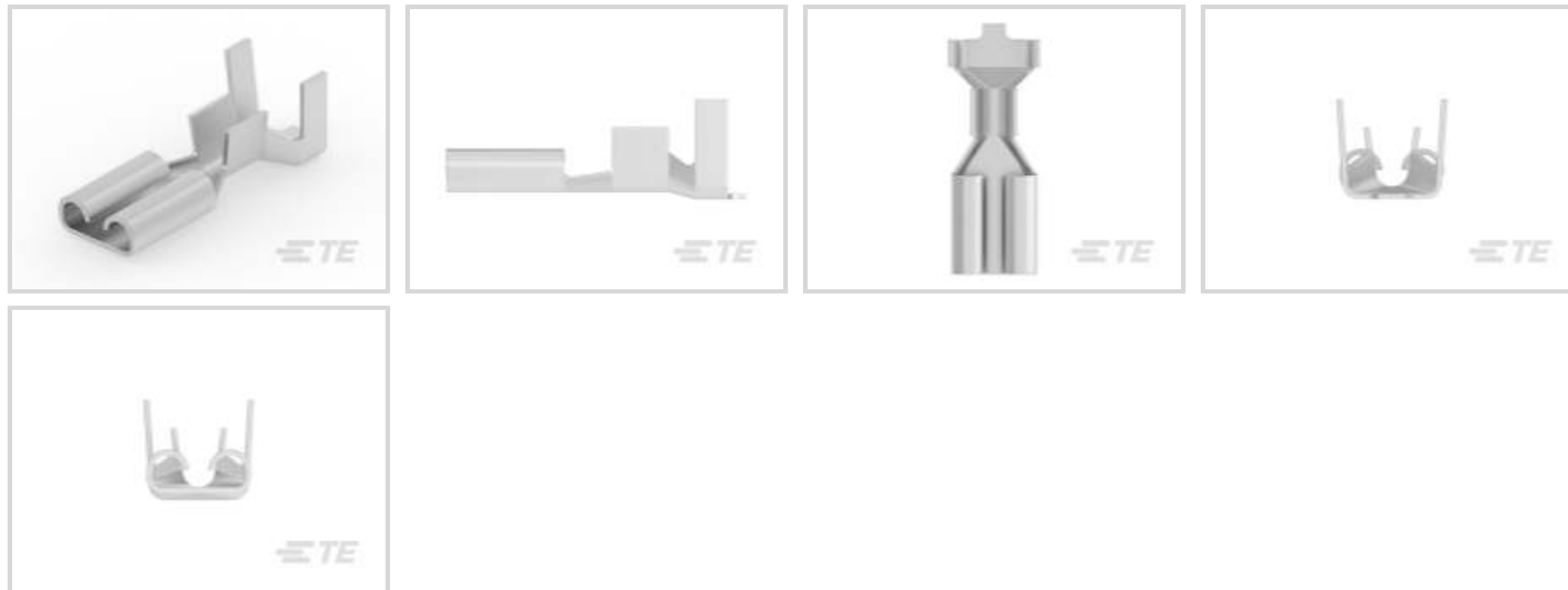

**Product Compliance**

[For compliance documentation, visit the product page on TE.com>](#)

EU RoHS Directive 2011/65/EU	Compliant
EU ELV Directive 2000/53/EC	Compliant
China RoHS 2 Directive MIIT Order No 32, 2016	No Restricted Materials Above Threshold
EU REACH Regulation (EC) No. 1907/2006	Current ECHA Candidate List: JUNE 2023 (235) Candidate List Declared Against: JUNE 2023 (235) Does not contain REACH SVHC
Halogen Content	Low Halogen - Br, Cl, F, I < 900 ppm per homogenous material. Also BFR/CFR/PVC Free
Solder Process Capability	Not applicable for solder process capability

Product Compliance Disclaimer

This information is provided based on reasonable inquiry of our suppliers and represents our current actual knowledge based on the information they provided. This information is subject to change. The part numbers that TE has identified as EU RoHS compliant have a maximum concentration of 0.1% by weight in homogenous materials for lead, hexavalent chromium, mercury, PBB, PBDE, DBP, BBP, DEHP, DIBP, and 0.01% for cadmium, or qualify for an exemption to these limits as defined in the Annexes of Directive 2011/65/EU (RoHS2). Finished electrical and electronic equipment products will be CE marked as required by Directive 2011/65/EU. Components may not be CE marked. Additionally, the part numbers that TE has identified as EU ELV compliant have a maximum concentration of 0.1% by weight in homogenous materials for lead, hexavalent chromium, and mercury, and 0.01% for cadmium, or qualify for an exemption to these limits as defined in the Annexes of Directive 2000/53/EC (ELV). Regarding the REACH Regulation, the information TE provides on SVHC in articles for this part number is based on the latest European Chemicals Agency (ECHA) 'Guidance on requirements for substances in articles' posted at this URL: <https://echa.europa.eu/guidance-documents/guidance-on-reach>

**Compatible Parts**



Also in the Series | **FASTON 187**

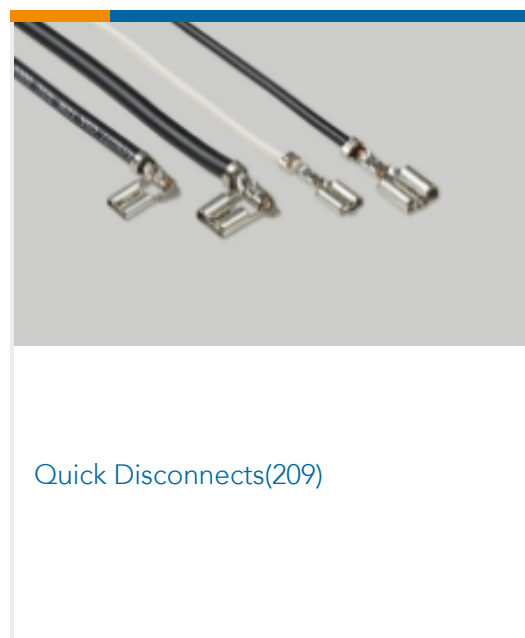
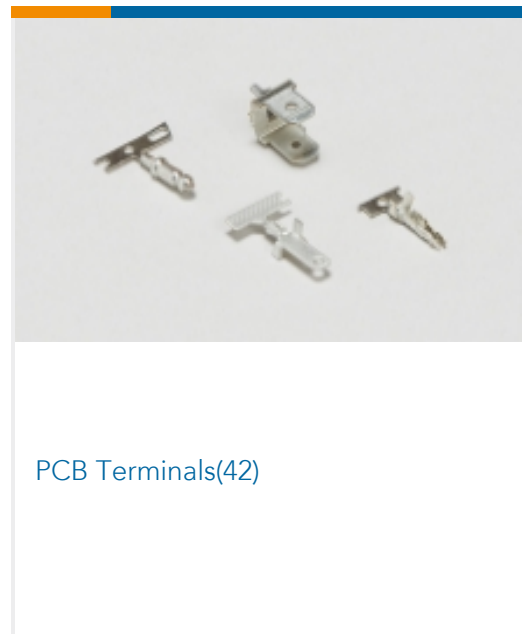
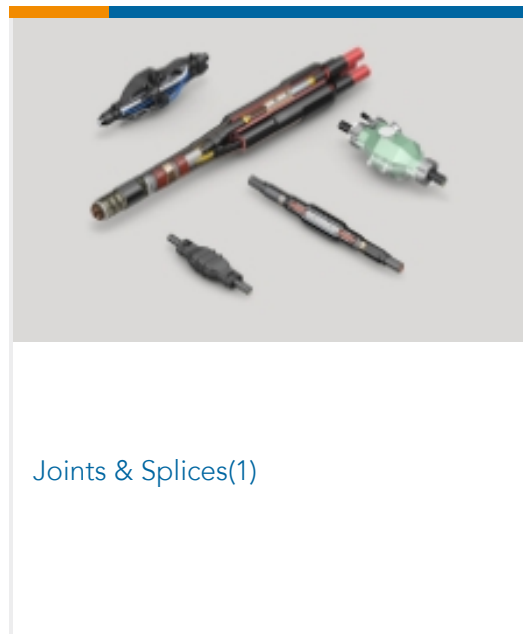
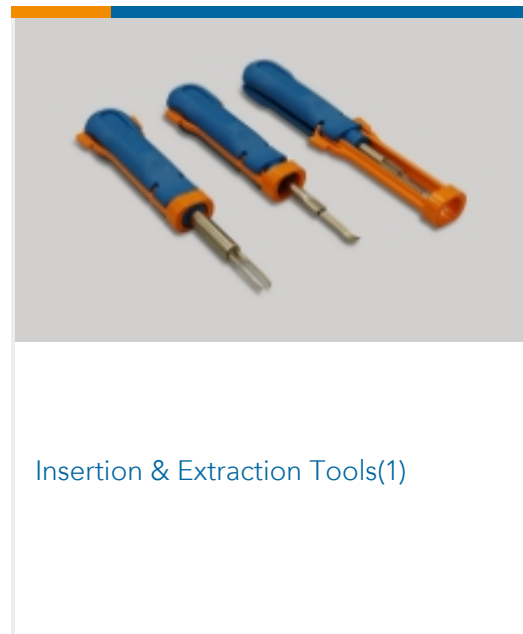
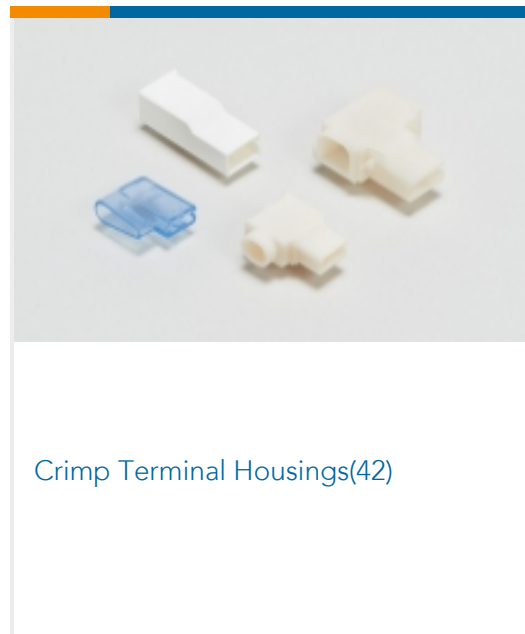

Customers Also Bought

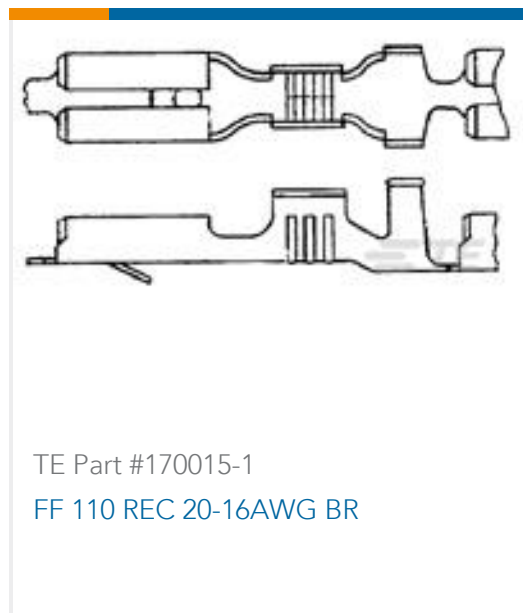



TE Part #62137-2  
187 FASTON REC 20-16 TPBR



TE Part #63896-1  
250 FASTON REC 16-12 AWG BR



TE Part #1871415-1  
AMPSEAL16,CAP ASSY,8P-A,B/R TYPE,  
RWDS,



TE Part #2-33459-6  
TERMINAL,SOLIS R 12-10 5/16



TE Part #1217918-1  
250 FASTON,NICHROME TAB,20-15  
AWG,NPST



TE Part #170801-4  
FF 110 REC HSG 4P NYLON NATURAL

## Documents

### Product Drawings

#### 187 FASTON REC 18-16 AWG TPBR

English

### CAD Files

#### Customer View Model

[ENG\\_CVM\\_CVM\\_60487-2\\_AB.2d\\_dxf.zip](#)

English

#### 3D PDF

3D

#### Customer View Model

[ENG\\_CVM\\_CVM\\_60487-2\\_AB.3d\\_igs.zip](#)

English

#### Customer View Model

[ENG\\_CVM\\_CVM\\_60487-2\\_AB.3d\\_stp.zip](#)

English

By downloading the CAD file I accept and agree to the [Terms and Conditions](#) of use.

### Datasheets & Catalog Pages

#### 82004 FASTON Terminals (Insulated and Uninsulated) Catalog - FASTON Receptacles Section

English

### Product Specifications

#### Application Specification

English

### Product Environmental Compliance

[MD\\_60487-2\\_05312018953\\_dmtec](#)



English

[MD\\_60487-2\\_05312018953\\_dmtec](#)

English

---

[Agency Approvals](#)

[UL Report](#)

English