

LT8580

Boost/SEPIC/Inverting Regulator

DESCRIPTION

Demonstration circuits 2186A-A and 2186A-B feature the LT8580EDD in boost/inverting configurations. The demo circuits demonstrate small size and low component count. The boost is designed to convert a 3V to 10V source to 12V at 120mA. The inverter converts a 5V to 12V source to -12V at 150mA. Please refer to Figures 4 and 5 below for maximum load current at different input voltage levels.

Both converters use only one feedback resistor to set the output voltage.

The **LT[®]8580** can operate with inputs as high as 40V but in these demo circuits, the input is limited by the voltage rating of the input capacitors, and the magnitude of the boost output voltage.

DC2186 includes an optional charge pump circuit on the back of the board, for higher output voltages. If this circuit is used, remove R11 and recalculate the feedback resistor. The same output node will have the output of the charge pump.

The LT8580 includes many other features such as synchronization to external clock, user configurable under-voltage lockout, soft-start, frequency foldback, and it is easily configured as boost, SEPIC or inverting converter.

The data sheet gives a complete description of the device, operation and application information. The data sheet must be read in conjunction with this demo manual for DC2186A.

Design files for this circuit board are available at <http://www.linear.com/demo/DC2186A>

LT, LT, LTC, LTM, Linear Technology and the Linear logo are registered trademarks of Linear Technology Corporation. All other trademarks are the property of their respective owners.

PERFORMANCE SUMMARY DC2186A-A

Specifications are at $T_A = 25^\circ\text{C}$

SYMBOL	PARAMETER	CONDITIONS	MIN	TYP	MAX	UNITS
V_{IN}	Input Supply Range		3		10	V
V_{OUT}	Output Voltage Range	$V_{IN} = 3\text{V}, I_{LOAD} = 120\text{mA}$	11.64	12	12.36	V
RIPPLE		$V_{IN} = 3\text{V}, I_{LOAD} = 120\text{mA}$		25		mV
EFFICIENCY		$V_{IN} = 5\text{V}, I_{LOAD} = 200\text{mA}$		88		%
SWITCHING FREQUENCY				1.5		MHz

PERFORMANCE SUMMARY DC2186A-B

Specifications are at $T_A = 25^\circ\text{C}$

SYMBOL	PARAMETER	CONDITIONS	MIN	TYP	MAX	UNITS
V_{IN}	Input Supply Range		5		12	V
V_{OUT}	Output Voltage Range	$V_{IN} = 5\text{V}, I_{LOAD} = 150\text{mA}$	-11.64	-12	-12.36	V
RIPPLE		$V_{IN} = 5\text{V}, I_{LOAD} = 150\text{mA}$		5		mV
EFFICIENCY		$V_{IN} = 12\text{V}, I_{LOAD} = 200\text{mA}$		82		%
SWITCHING FREQUENCY				1.5		MHz

QUICK START PROCEDURE

DC2186A is easy to set up to evaluate the performance of the LT8580. Refer to Figures 1 and 2 for proper measurement equipment setup and follow the procedure below:

NOTE: When measuring the input or output voltage ripple, care must be taken to avoid a long ground lead on the oscilloscope probe. Measure the input or output voltage ripple by touching the probe tip directly across the V_{IN} or V_{OUT} and GND terminals. See Figure 3 for proper scope probe technique.

1. With power off, connect the input power supply to V_{IN} and GND.

2. Turn on the power at the input.

NOTE: Make sure that the input voltage does not exceed 10V for DC2186A-A and 12V for DC2186A-B.

3. Check for the proper output voltage.

NOTE: If there is no output, temporarily disconnect the load to make sure that the load is not set too high.

4. Once the proper output voltages are established, adjust the load within the operating range and observe the output voltage regulation, ripple voltage, efficiency and other parameters.

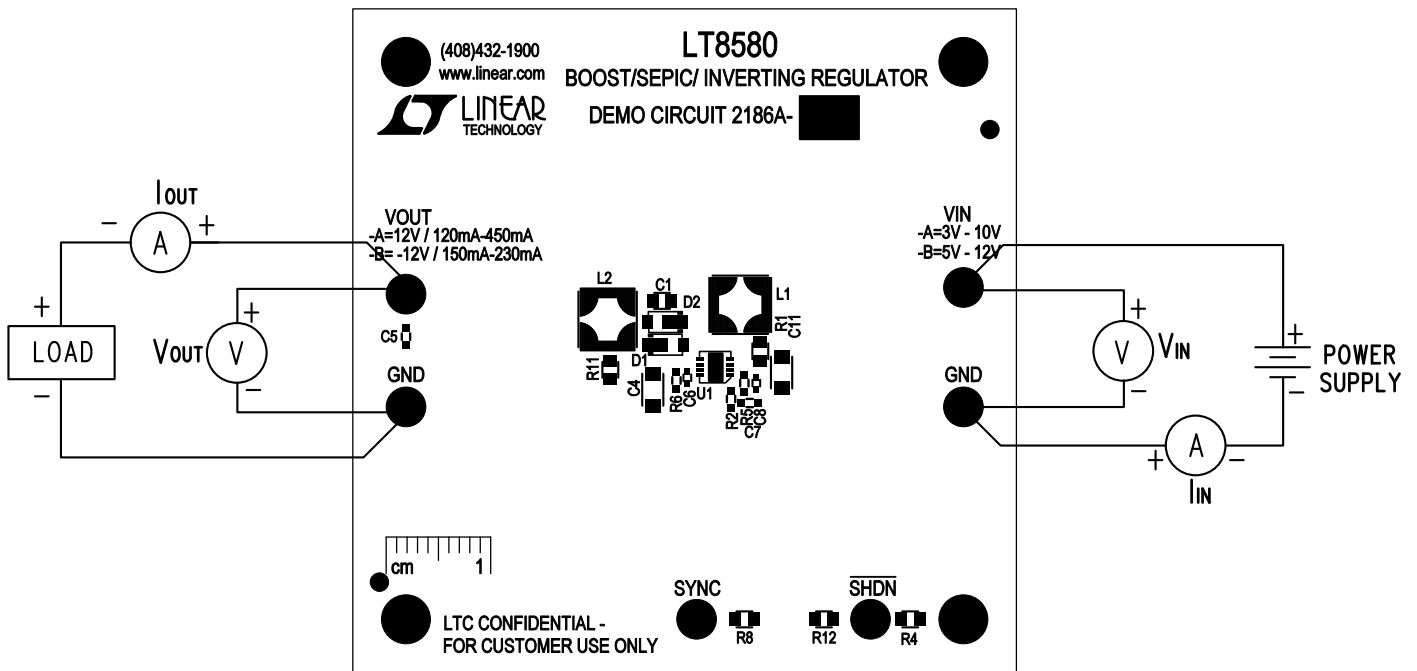

Figure 1. DC2186A-A Proper Equipment Setup

QUICK START PROCEDURE

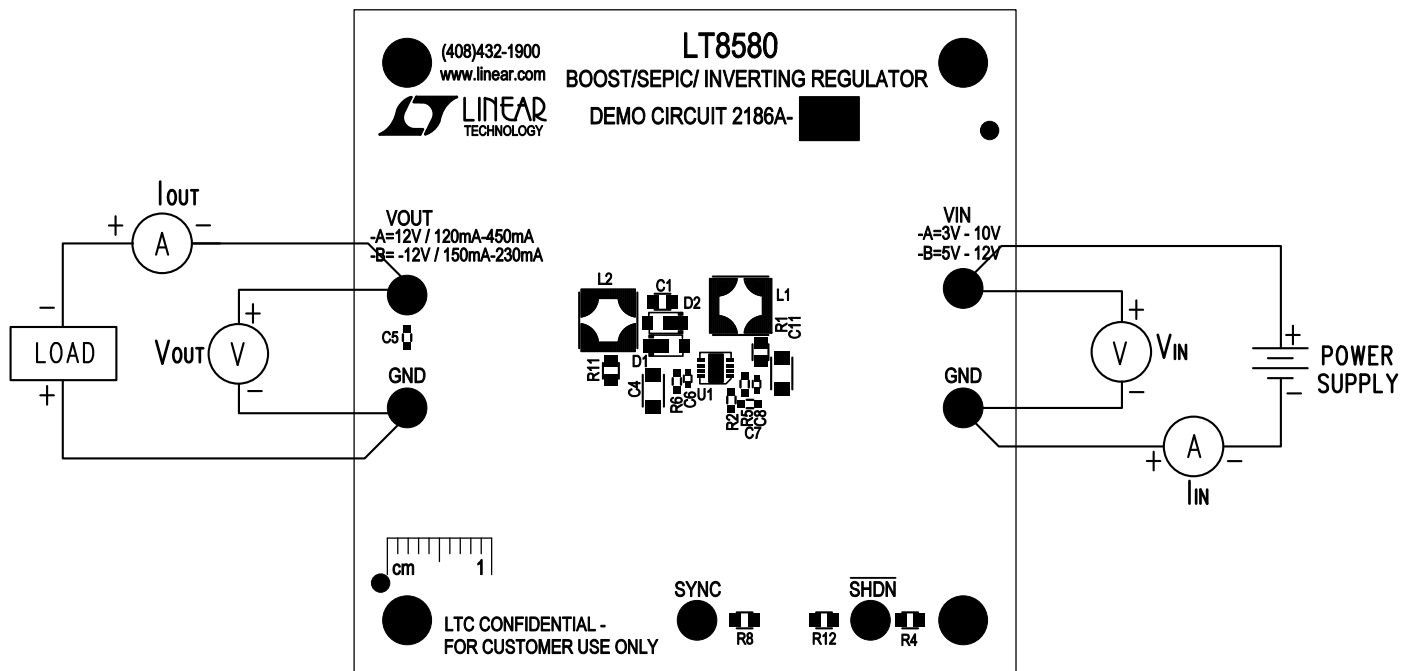

Figure 2. DC2186A-B Proper Equipment Setup

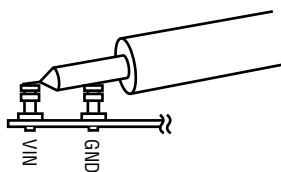
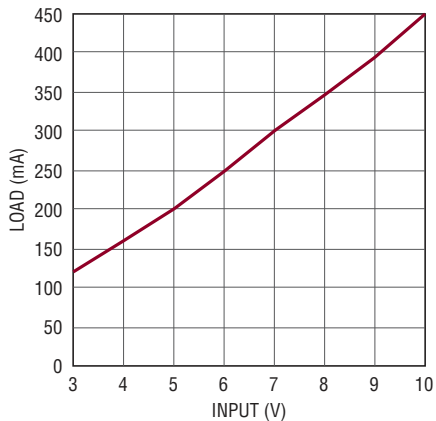

Figure 3. Measuring Input or Output Ripple

QUICK START PROCEDURE



DC2186A F04

Figure 4. DC2186A-A Maximum Load Current vs Input Voltage

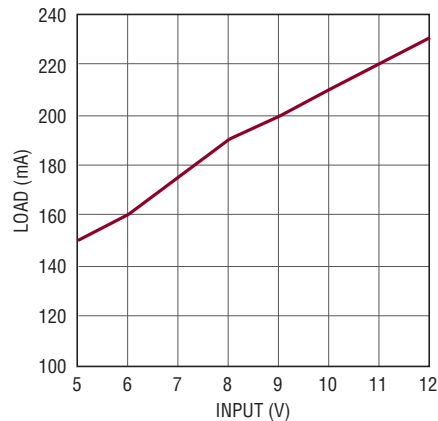

DC2186A F05

Figure 5. DC2186A-B Maximum Load Current vs Input Voltage

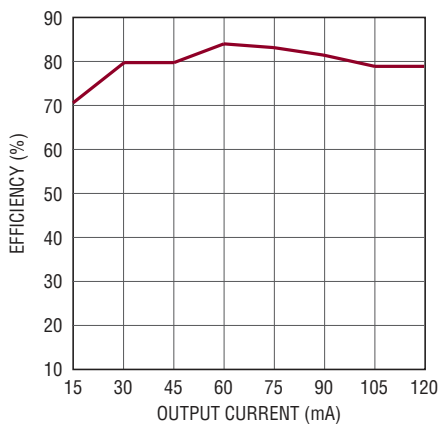

DC2186A F06

Figure 6. DC2186A-A Efficiency at 3V_{IN}

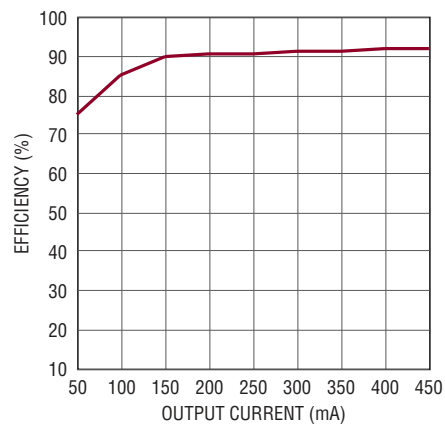

DC2186A F07

Figure 7. DC2186A-A Efficiency at 10V_{IN}

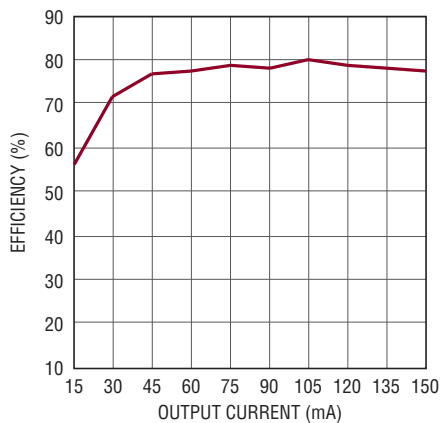

DC2186A F08

Figure 8. DC2186A-B Efficiency at 5V_{IN}

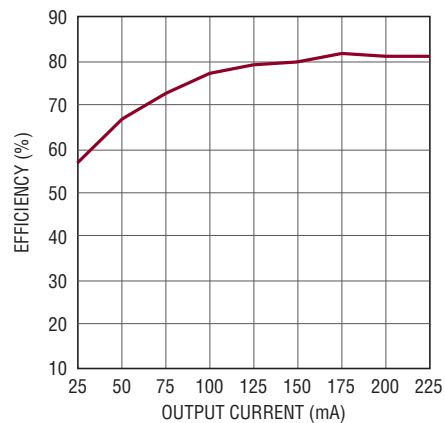

DC2186A F09

Figure 9. DC2186A-B Efficiency at 12V_{IN}

PARTS LIST

ITEM	QTY	REFERENCE	PART DESCRIPTION	MANUFACTURER/PART NUMBER
DC2186A-A Required Circuit Components				
1	2	C4, C11	CAP., X7R, 4.7µF, 16V, 10% 1206	MURATA, GRM31CR71C475KA01L
2	1	C5	CAP., X7R, 0.1µF, 16V, 10% 0603	MURATA, GRM188R71C104KA01D
3	1	C6	CAP., X7R, 0.1µF, 16V, 10% 0402	MURATA, GRM155R71C104KA88D
4	1	C7	CAP., X7R, 3.3nF, 16V, 10% 0603	AVX, 0603YC332KAT2A
5	1	C8	CAP., COG, 47pF, 16V, 5% 0402	MURATA, GRM1555C1E470JA01D
6	1	D1	DIODE, DFSL130L PowerDI123	DIODES., DFSL130L-7
7	1	L1	INDUCTOR, 15µH, SD18	COOPER, SD18-150-R
8	2	R1, R11	RES., CHIP., 0Ω, 1/8W, 0805	VISHAY, CRCW08050000Z0EA
9	1	R2	RES., CHIP., 130k, 1/10W, 1%, 0603	VISHAY, CRCW0603130KFKEA
10	1	R5	RES., CHIP., 6.04k, 1/10W, 1%, 0603	VISHAY, CRCW06036K04FKEA
11	1	R4	RES., CHIP., 10k, 1/8W, 1%, 0805	VISHAY, CRCW080510K0FKEA
12	1	R6	RES., CHIP., 56.2k, 1/10W, 1%, 0603	VISHAY, CRCW060356K2FKEA
13	1	R8	RES., CHIP., 100k, 1/8W, 1%, 0805	VISHAY, CRCW0805100KFKEA
14	1	R12	RES., CHIP., 11.3k, 1/8W, 1%, 0805	VISHAY, CRCW080511K3FKEA
15	1	U1	IC., LT8580EDD 8L DFN	LINEAR TECH., LT8580EDD#TRPBF
Additional Demo Board Circuit Components				
1	0	C9 (OPT)	CAP., 0805	
2	0	C10 (OPT)	CAP., 1206	
3	0	D3, D4 (OPT)	DIODE, Di123	
4	0	C1 (OPT)	CAP., 0805	
5	0	D2 (OPT)	DIODE, PowerDI123	
6	0	L2 (OPT)	INDUCTOR	
7	0	R9, R10 (OPT)	RES., CHIP., 0805	
Hardware: For Demo Board Only				
1	6	E1-E6	TESTPOINT, TURRET, .094" PBF	MILL-MAX, 2501-2-00-80-00-00-07-0
2	4	MH1-MH4	STAND-OFF, NYLON 0.25"	KEYSTONE, 8831(SNAP ON)

DEMO MANUAL DC2186A

PARTS LIST

ITEM	QTY	REFERENCE	PART DESCRIPTION	MANUFACTURER/PART NUMBER
DC2186A-B Required Circuit Components				
1	1	C1	CAP., X5R, 1 μ F, 25V, 10% 0805	AVX, 08053D105KAT2A
2	2	C4, C11	CAP., X7R, 4.7 μ F, 16V, 10% 1206	MURATA, GRM31CR71C475KA01L
3	1	C5	CAP., X7R, 0.1 μ F, 16V, 10% 0603	MURATA, GRM188R71C104KA01D
4	1	C6	CAP., X7R, 0.1 μ F, 16V, 10% 0402	MURATA, GRM155R71C104KA88D
5	1	C7	CAP., X7R, 2.2nF, 16V, 10% 0603	AVX, 0603YC222KAT2A
6	1	C8	CAP., COG, 47pF, 16V, 5% 0402	MURATA, GRM1555C1E470JA01D
7	1	D2	DIODE, DFLS130L PowerDI123	DIODES., DFLS130L-7
8	2	L1, L2	INDUCTOR, 33 μ H, SD18	COOPER, SD18-330-R
9	2	R1, R11	RES., CHIP., 0 Ω , 1/8W, 0805	VISHAY, CRCW08050000Z0EA
10	1	R2	RES., CHIP., 143k, 1/10W, 1%, 0603	VISHAY, CRCW0603143KFKEA
11	1	R4	RES., CHIP., 10k, 1/8W, 1%, 0805	VISHAY, CRCW080510K0FKEA
12	1	R5	RES., CHIP., 20k, 1/10W, 1%, 0603	VISHAY, CRCW060320K0FKEA
13	1	R6	RES., CHIP., 56.2k, 1/10W, 1%, 0603	VISHAY, CRCW060356K2FKEA
14	1	R8	RES., CHIP., 100k, 1/8W, 1%, 0805	VISHAY, CRCW0805100KFKEA
15	1	R12	RES., CHIP., 22.1k, 1/8W, 1%, 0805	VISHAY, CRCW080522K1FKEA
16	1	U1	IC., LT8580EDD 8L DFN	LINEAR TECH., LT8580EDD#TRPBF
Additional Demo Board Circuit Components				
1	0	C9 (OPT)	CAP., 0805	
2	0	C10 (OPT)	CAP., 1206	
3	0	D3, D4 (OPT)	DIODE, Di123	
4	0	D1 (OPT)	DIODE, PowerDI123	
5	0	R9, R10 (OPT)	RES., CHIP., 0805	
Hardware: For Demo Board Only				
1	6	E1-E6	TESTPOINT, TURRET, .094" PBF	MILL-MAX, 2501-2-00-80-00-00-07-0
2	4	MH1-MH4	STAND-OFF, NYLON 0.25"	KEYSTONE, 8831(SNAP ON)

SCHEMATIC DIAGRAM

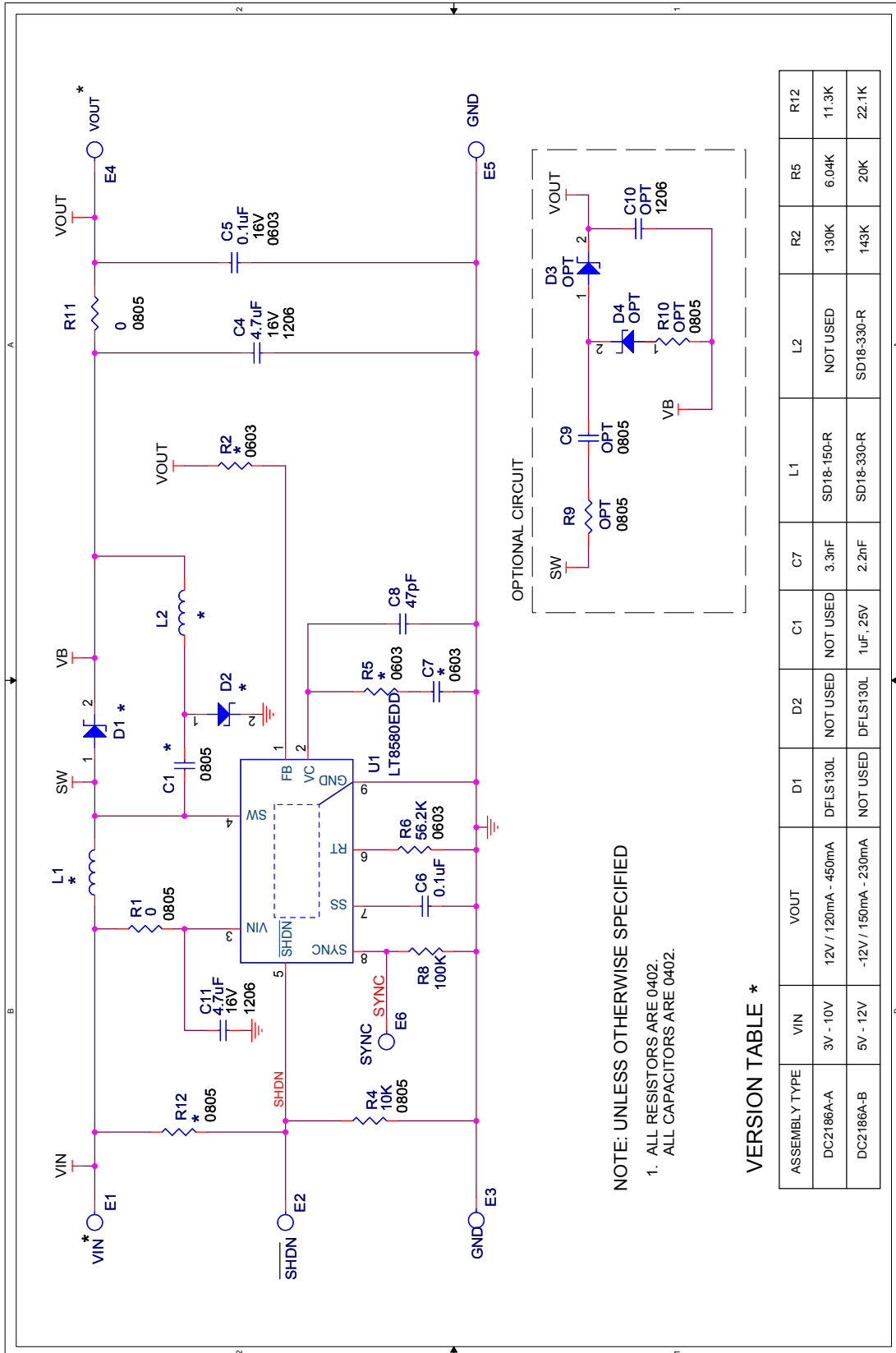

DEMO MANUAL DC2186A

DEMONSTRATION BOARD IMPORTANT NOTICE

Linear Technology Corporation (LTC) provides the enclosed product(s) under the following **AS IS** conditions:

This demonstration board (DEMO BOARD) kit being sold or provided by Linear Technology is intended for use for **ENGINEERING DEVELOPMENT OR EVALUATION PURPOSES ONLY** and is not provided by LTC for commercial use. As such, the DEMO BOARD herein may not be complete in terms of required design-, marketing-, and/or manufacturing-related protective considerations, including but not limited to product safety measures typically found in finished commercial goods. As a prototype, this product does not fall within the scope of the European Union directive on electromagnetic compatibility and therefore may or may not meet the technical requirements of the directive, or other regulations.

If this evaluation kit does not meet the specifications recited in the DEMO BOARD manual the kit may be returned within 30 days from the date of delivery for a full refund. **THE FOREGOING WARRANTY IS THE EXCLUSIVE WARRANTY MADE BY THE SELLER TO BUYER AND IS IN LIEU OF ALL OTHER WARRANTIES, EXPRESSED, IMPLIED, OR STATUTORY, INCLUDING ANY WARRANTY OF MERCHANTABILITY OR FITNESS FOR ANY PARTICULAR PURPOSE. EXCEPT TO THE EXTENT OF THIS INDEMNITY, NEITHER PARTY SHALL BE LIABLE TO THE OTHER FOR ANY INDIRECT, SPECIAL, INCIDENTAL, OR CONSEQUENTIAL DAMAGES.**

The user assumes all responsibility and liability for proper and safe handling of the goods. Further, the user releases LTC from all claims arising from the handling or use of the goods. Due to the open construction of the product, it is the user's responsibility to take any and all appropriate precautions with regard to electrostatic discharge. Also be aware that the products herein may not be regulatory compliant or agency certified (FCC, UL, CE, etc.).

No License is granted under any patent right or other intellectual property whatsoever. **LTC assumes no liability for applications assistance, customer product design, software performance, or infringement of patents or any other intellectual property rights of any kind.**

LTC currently services a variety of customers for products around the world, and therefore this transaction **is not exclusive**.

Please read the DEMO BOARD manual prior to handling the product. Persons handling this product must have electronics training and observe good laboratory practice standards. **Common sense is encouraged.**

This notice contains important safety information about temperatures and voltages. For further safety concerns, please contact a LTC application engineer.

Mailing Address:

Linear Technology
1630 McCarthy Blvd.
Milpitas, CA 95035

Copyright © 2004, Linear Technology Corporation