



## Features:

- Frequency 868-920MHz
- Antenna type Folded PIFA
- Size 39 x 14.4 x 4.8 mm
- Radiation pattern Omni
- Impedance 50 Ohm
- Tape & Reel Packing
- RoHS compliant

## Applications:

- All Sigfox network regions
- Suitable for SMT mounting
- Extremely robust structure using single folded sheet metal radiator
- Tunable for application using radio PCB layout slot tuning features

All dimensions are in mm

Issue: 2042

In the effort to improve our products, we reserve the right to make changes judged to be necessary.

CONFIDENTIAL AND PROPRIETARY INFORMATION

This document contains confidential and proprietary information of Pulse Electronics, Inc. (Pulse) and is protected by copyright, trade secret and other state and federal laws. Its receipt or possession does not convey any rights to reproduce, disclose its contents, or to manufacture, use or sell anything it may describe. Reproduction, disclosure or use without specific written authorization of Pulse is strictly forbidden.

For more information:

Pulse Worldwide Headquarters  
15255 Innovation Drive #100  
San Diego, CA 92128  
USA  
Tel: 1-858-674-8100

Pulse/Larsen Antennas  
18110 SE 34<sup>th</sup> St Bldg 2 Suite 250  
Vancouver, WA 98683  
USA  
Tel: 1-360-944-7551

Europe Headquarters  
Pulse GmbH & Do, KG  
Zeppelinstrasse 15  
Herrenberg, Germany  
Tel: 49 7032 7806 0

Pulse (Suzhou) Wireless Products Co, Inc.  
99 Huo Ju Road(#29 Bldg,4<sup>th</sup> Phase  
Suzhou New District  
Jiangsu Province, Suzhou 215009 PR China  
Tel: 86 512 6807 9998

**ELECTRICAL SPECIFICATIONS**

Antenna Type	PIFA ANTENNA
Frequency	868-920MHz
Nominal Impedance	50 $\Omega$
Return Loss	< -12dB
Radiation Pattern	Omni
Gain	average -1.9dBi
Efficiency	average 30%
Polarization	Vertical

**MECHANICAL SPECIFICATIONS**

Overall Size	39 x 14.4 x 4.8 mm
Weight	3 g
Antenna Material	Ni-Plated Stainless Steel

**ENVIRONMENTAL SPECIFICATIONS**

Operating Temperature	-30 to +85° C
Storage Temperature	-30 to +85° C
RoHS Compliant	Yes

## MECHANICAL DRAWING

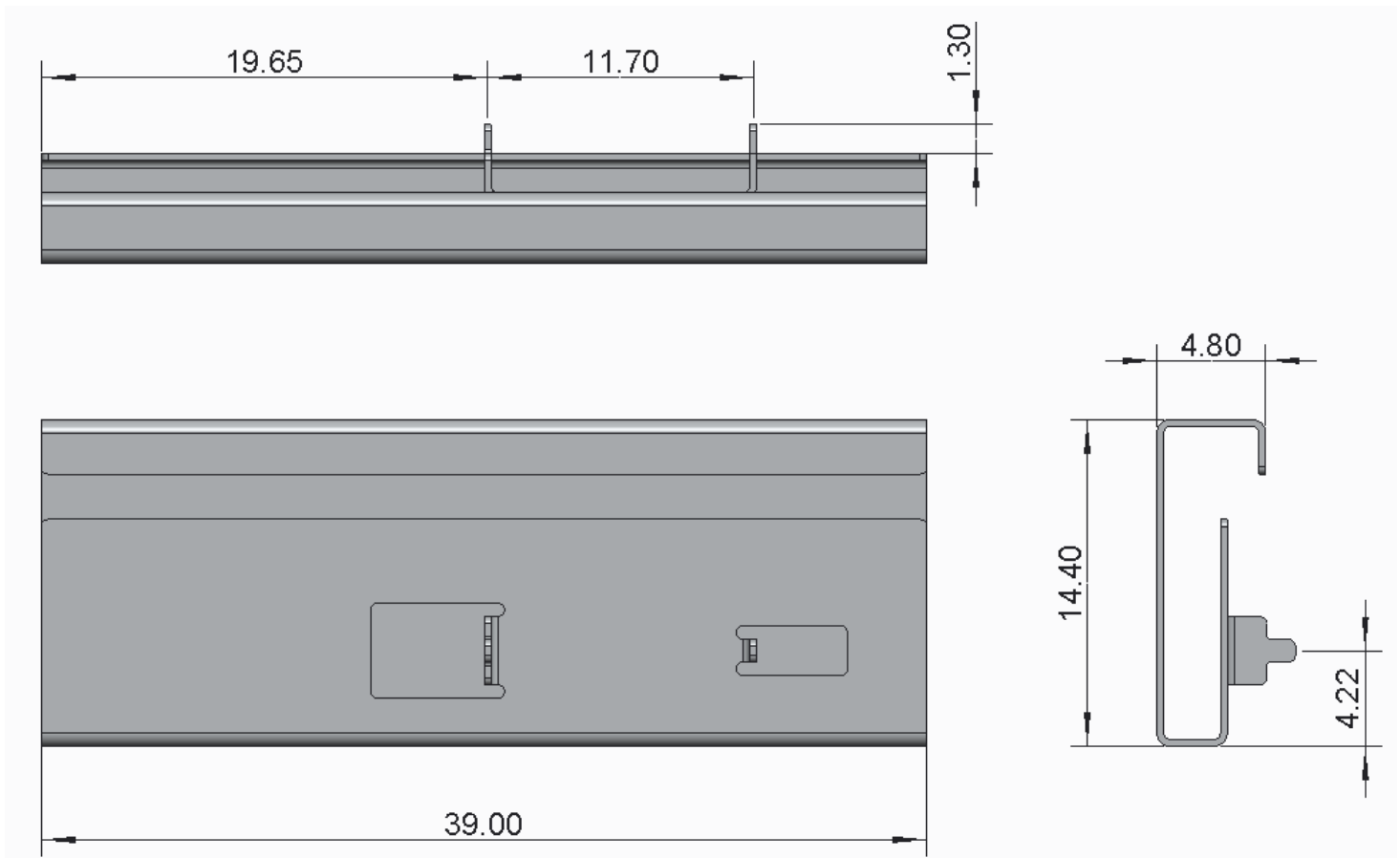

All dimensions are in mm.

## ASSEMBLY INSTRUCTIONS

Insert those 2 guiding pins to the PCB guiding holes (\*), then solder the antenna to PCB by SMT.

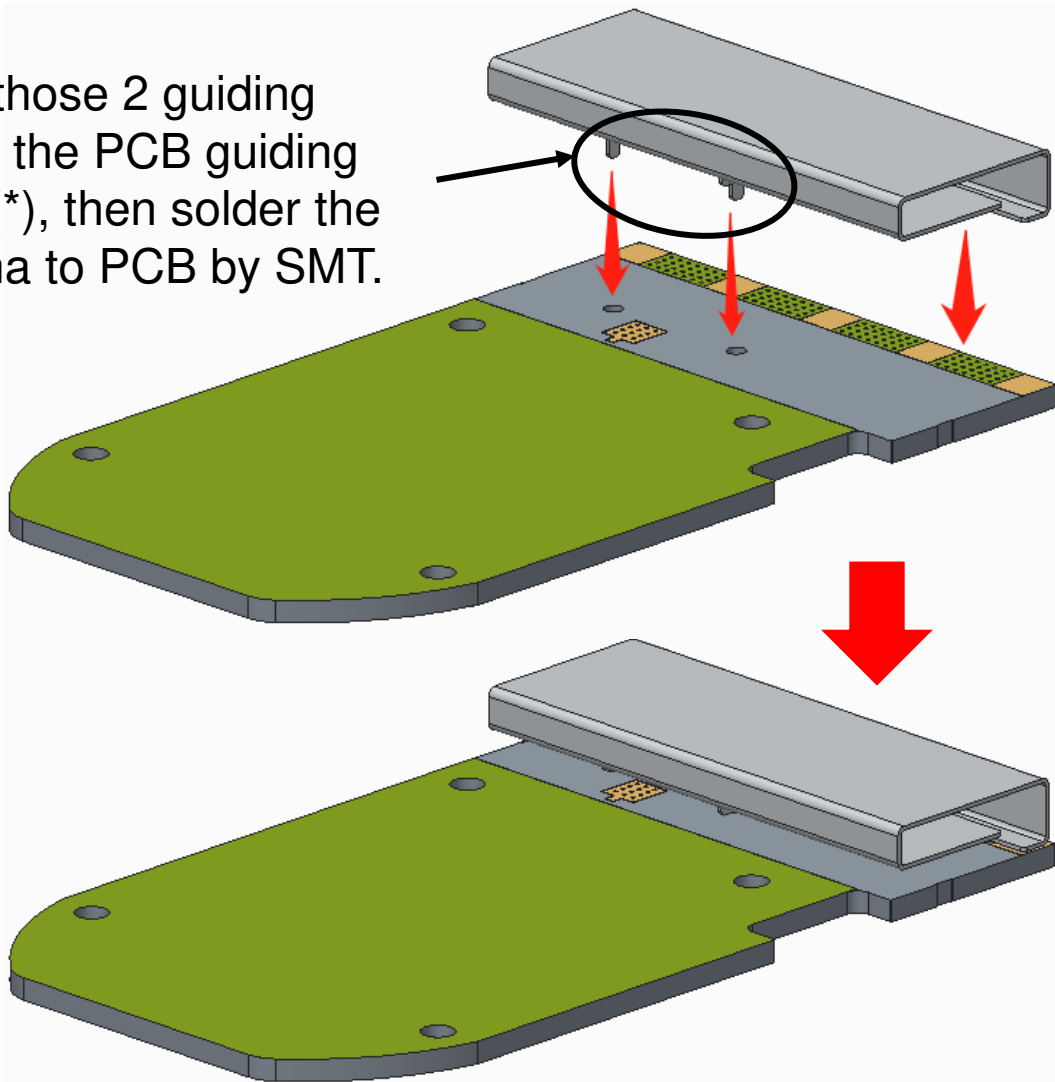

\* The 2 guiding holes on PCB must be non plated holes without any metal.

a YAGEO company

Series: EMBEDDED SMT

Description: 868-920MHz SMT PIFA

PART NUMBER: W3403

### Antenna PAD LAYOUT DRAWING

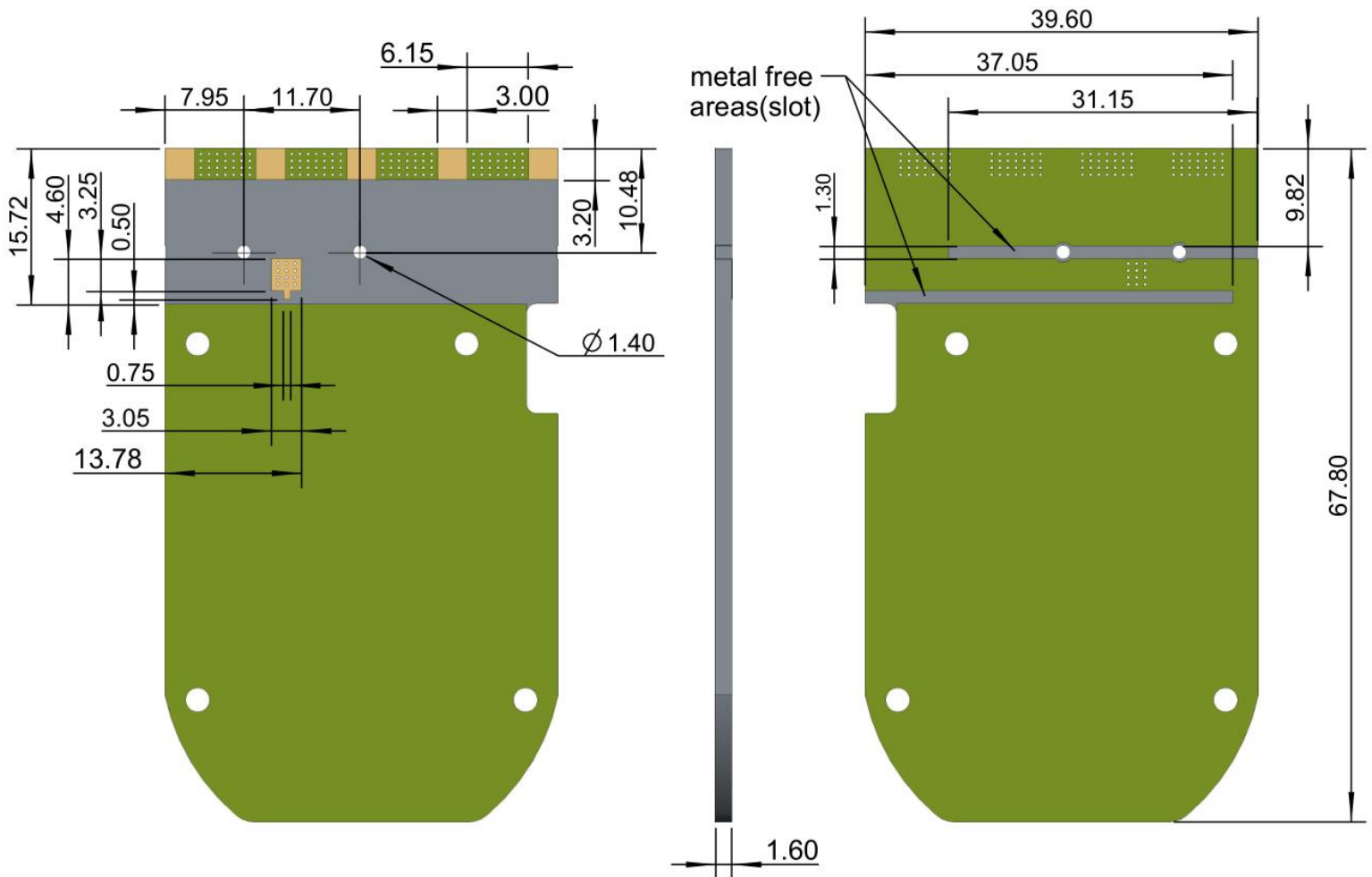

All dimensions are in mm.

Issue: 2042

In the effort to improve our products, we reserve the right to make changes judged to be necessary.

CONFIDENTIAL AND PROPRIETARY INFORMATION

This document contains confidential and proprietary information of Pulse Electronics, Inc. (Pulse) and is protected by copyright, trade secret and other state and federal laws. Its receipt or possession does not convey any rights to reproduce, disclose its contents, or to manufacture, use or sell anything it may describe. Reproduction, disclosure or use without specific written authorization of Pulse is strictly forbidden.

## Antenna PAD LAYOUT DRAWING

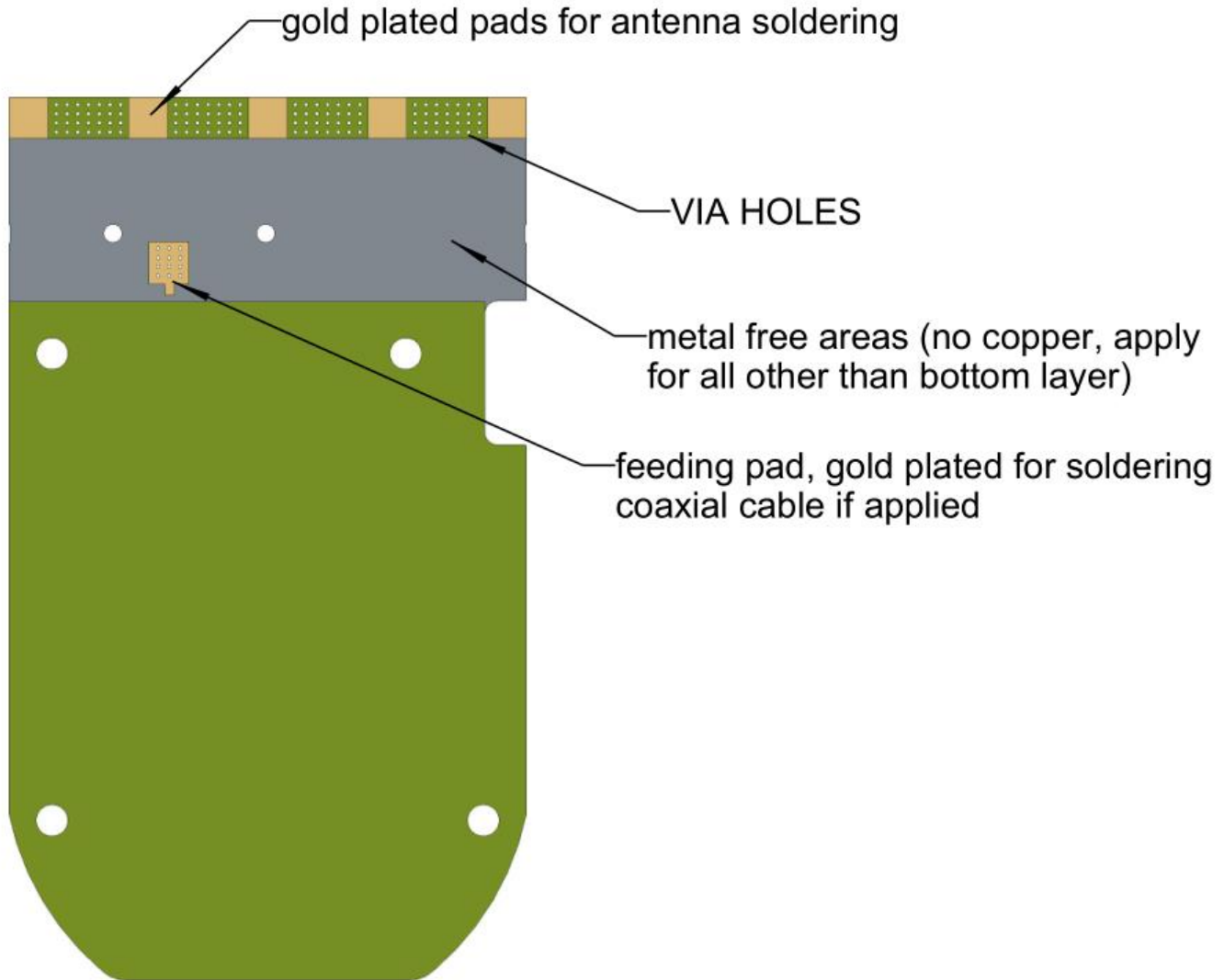

## CHARTS

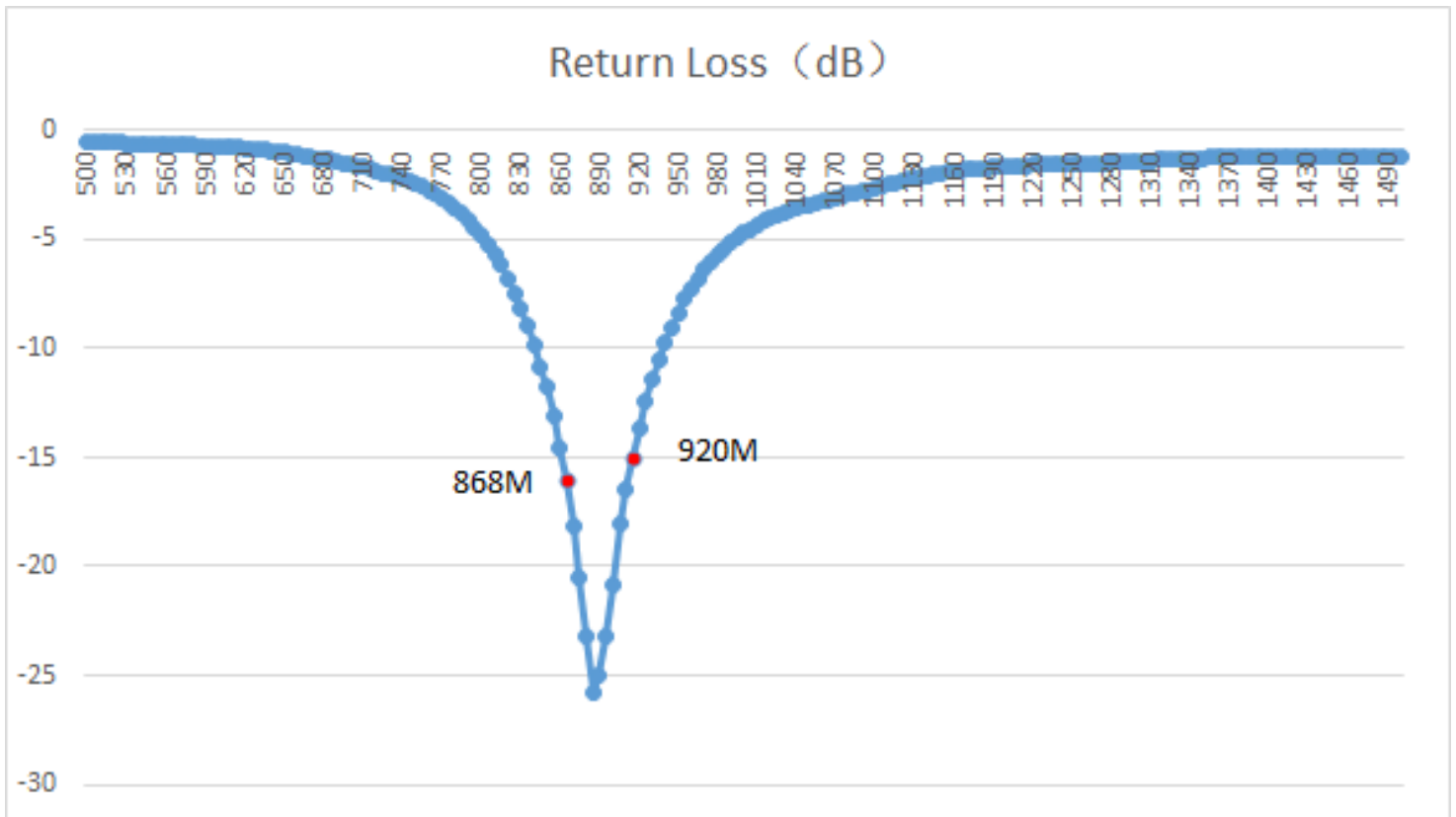

Test PCB size: 67.8mm\*39.6mm

a YAGEO company

Series: EMBEDDED SMT

Description: 868-920MHz SMT PIFA

PART NUMBER: W3403

## CHARTS

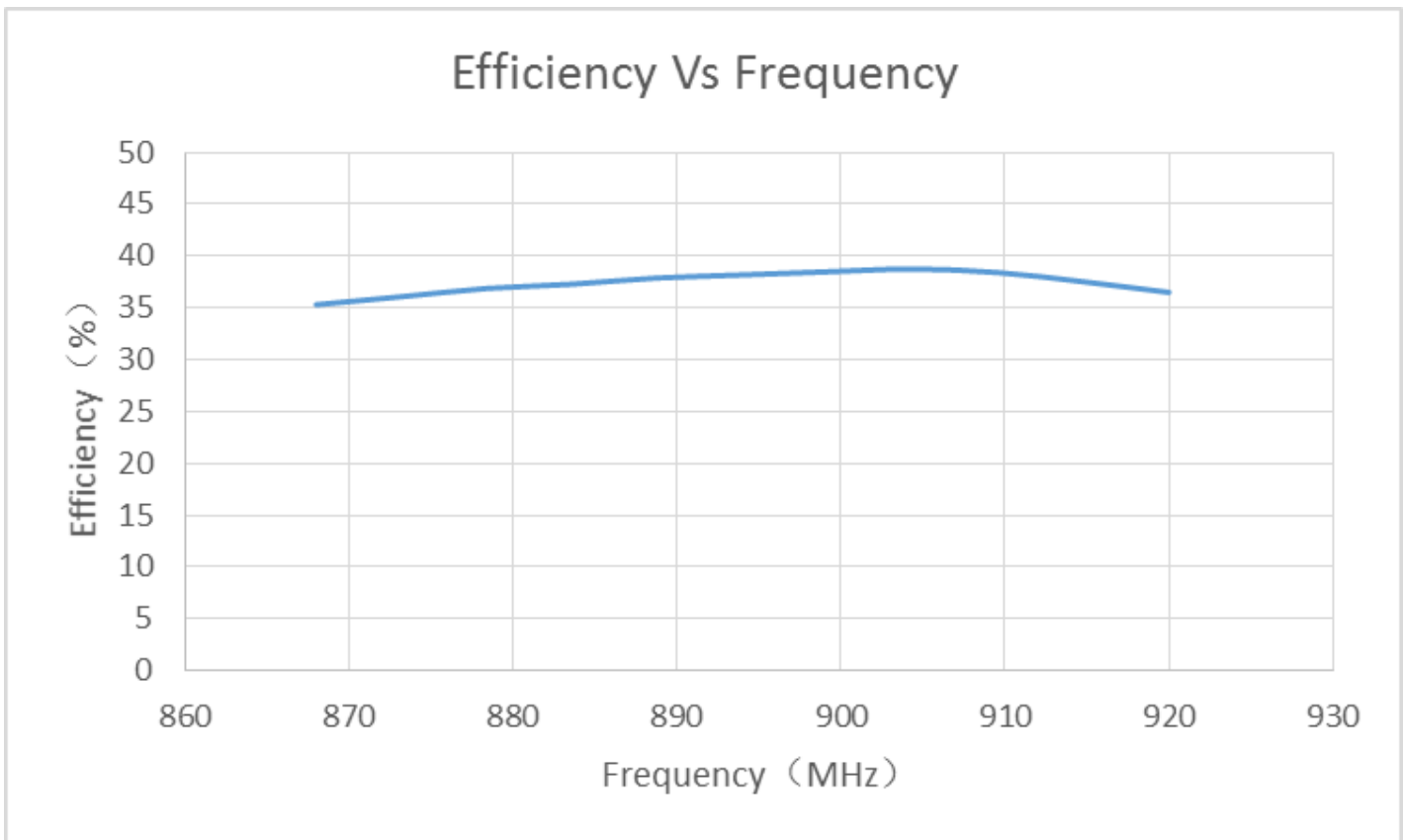

Test PCB size: 67.8mm\*39.6mm

Issue: 2042

In the effort to improve our products, we reserve the right to make changes judged to be necessary.

CONFIDENTIAL AND PROPRIETARY INFORMATION

This document contains confidential and proprietary information of Pulse Electronics, Inc. (Pulse) and is protected by copyright, trade secret and other state and federal laws. Its receipt or possession does not convey any rights to reproduce, disclose its contents, or to manufacture, use or sell anything it may describe. Reproduction, disclosure or use without specific written authorization of Pulse is strictly forbidden.

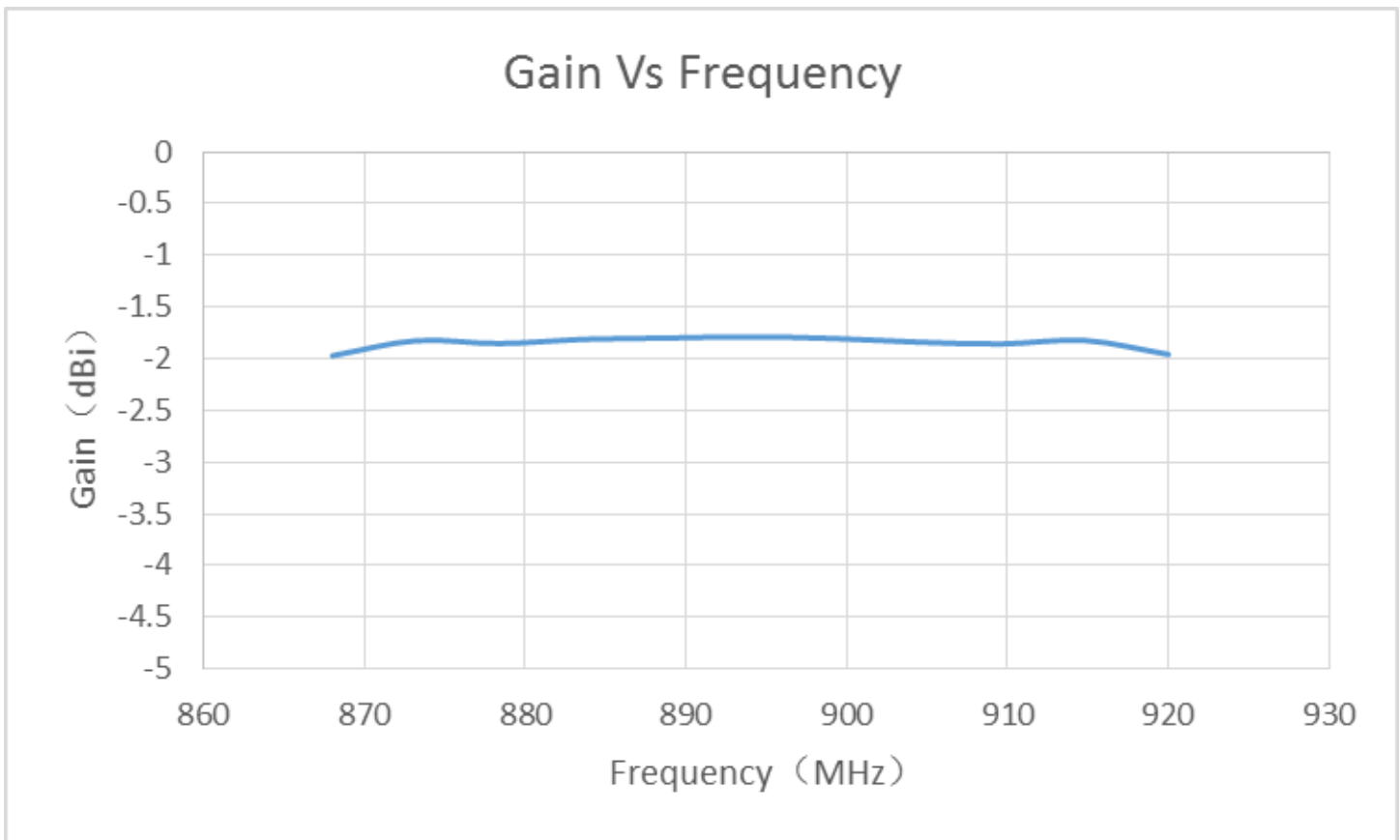

**CHARTS**

Test PCB size: 67.8mm\*39.6mm

a YAGEO company

Series: EMBEDDED SMT

Description: 868-920MHz SMT PIFA

PART NUMBER: W3403

## CHARTS

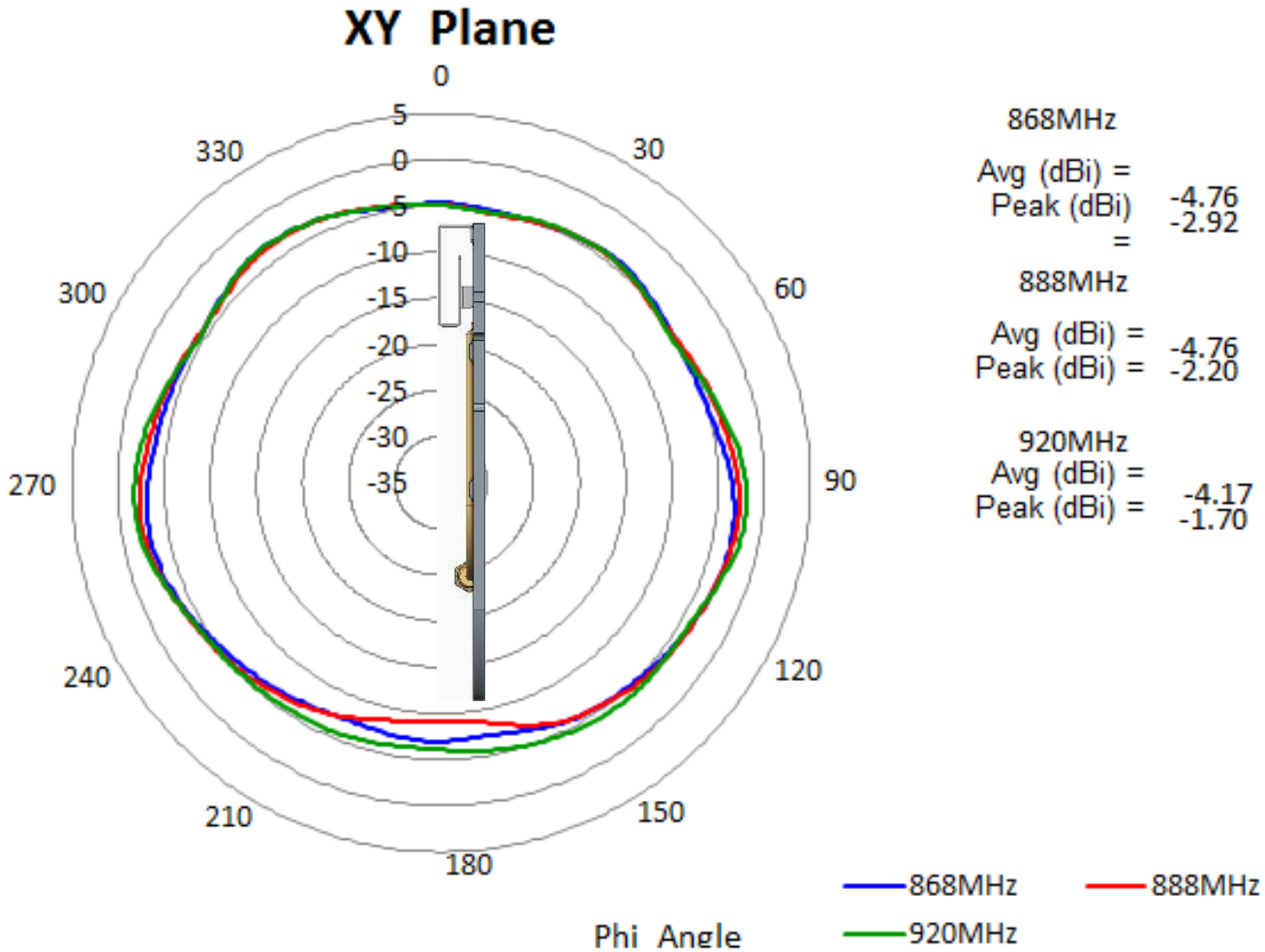

Test PCB size: 67.8mm\*39.6mm

a YAGEO company

Series: EMBEDDED SMT

Description: 868-920MHz SMT PIFA

PART NUMBER: W3403

## CHARTS

### XZ Plane

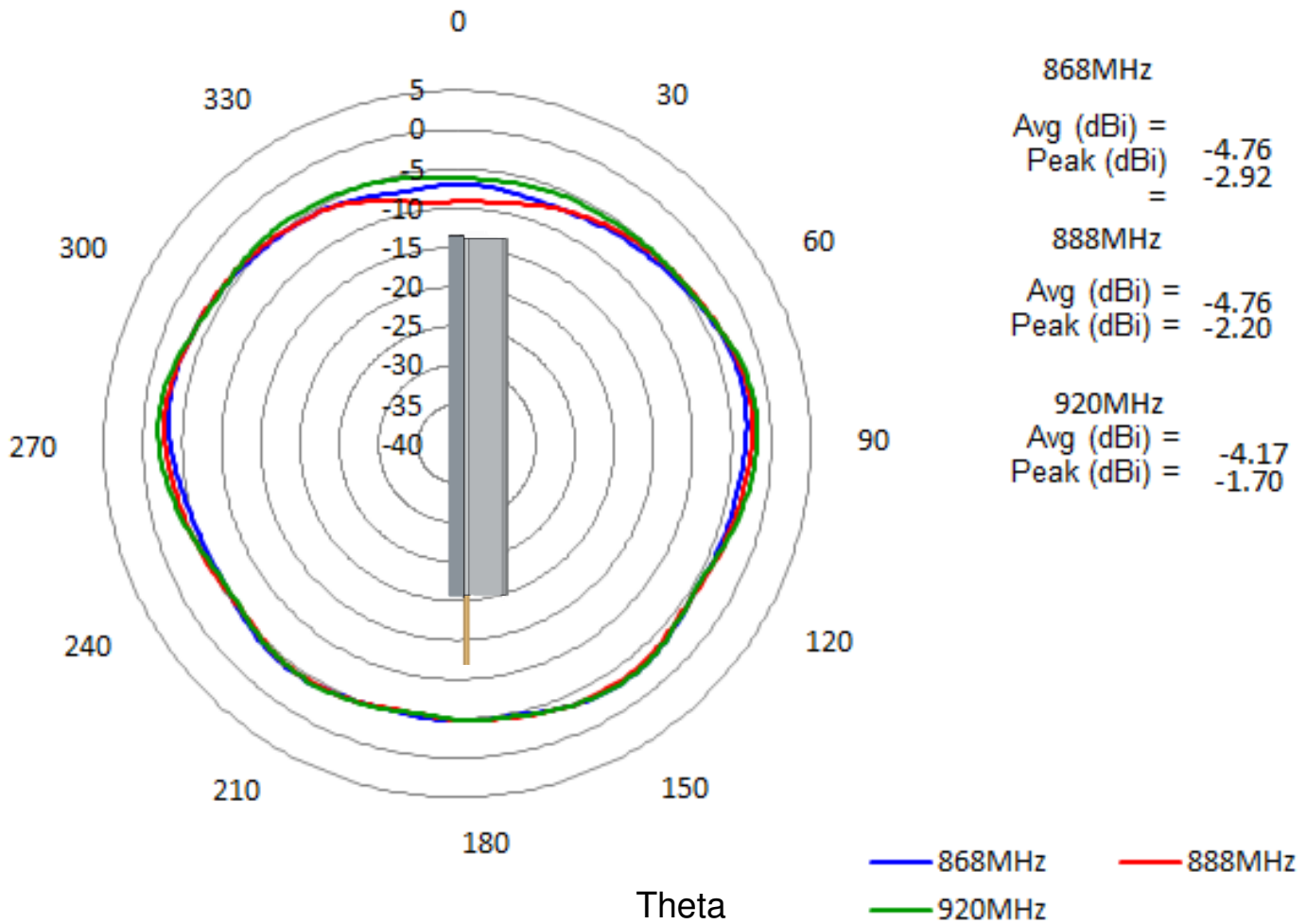

Test PCB size: 67.8mm\*39.6mm

a YAGEO company

Series: EMBEDDED SMT

Description: 868-920MHz SMT PIFA

PART NUMBER: W3403

## CHARTS

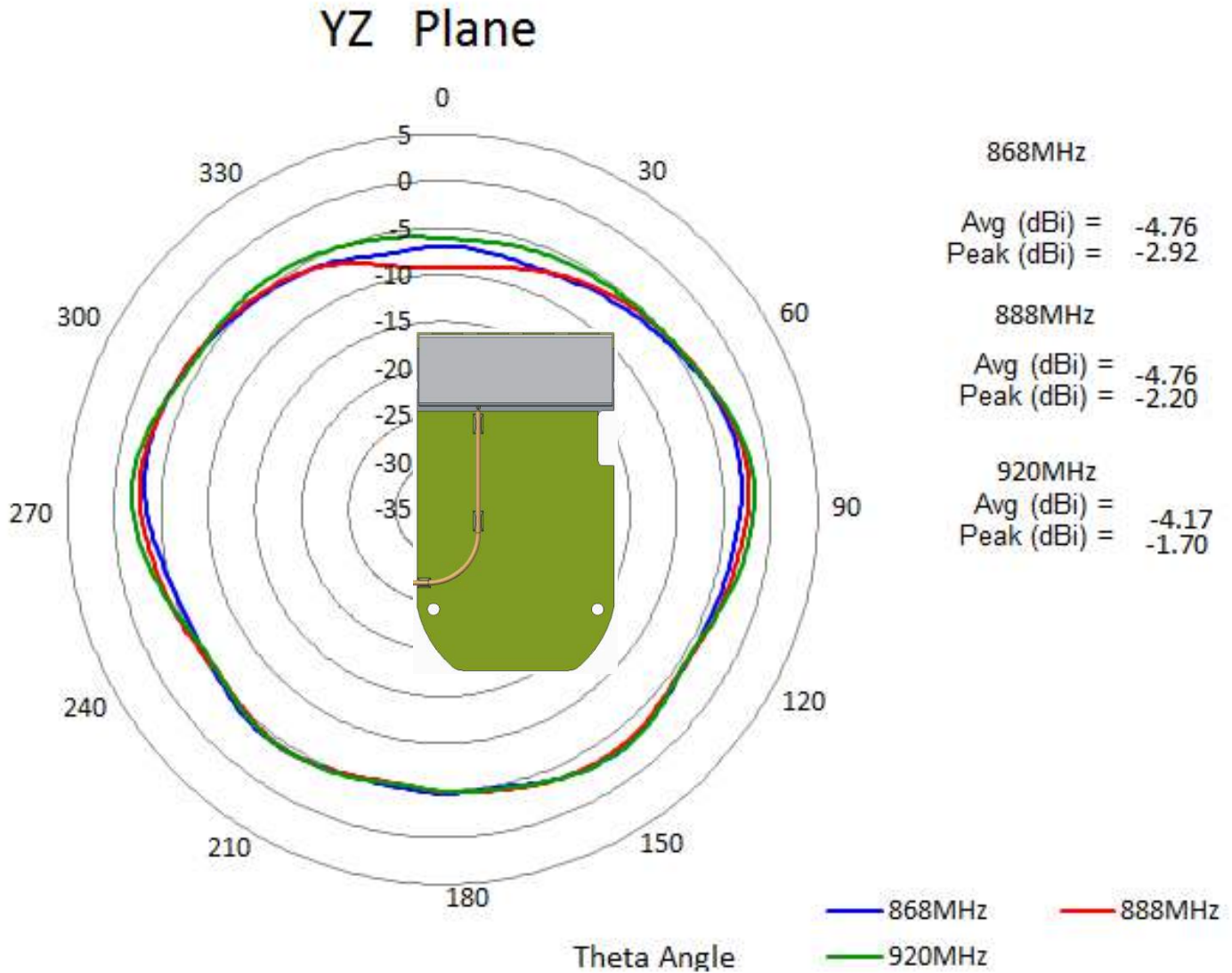

Test PCB size: 67.8mm\*39.6mm

## PACKAGING

450pcs / 13" Tape&Reel  
2 Tape&Reel / Box  
Total 900pcs antennas / Box

P.S.: 4.4Kg /Box

## ASSEMBLY

