

# Photointerrupter, encased type

## RPI-574

A positioning pin is provided on the external case to allow precise mounting.

### ●Application

Optical control equipment

### ●Features

- 1) Small slit width (0.5mm) for high precision.
- 2) Fast response.
- 3) Built-in visible light filter.

### ●External dimensions (Units : mm)

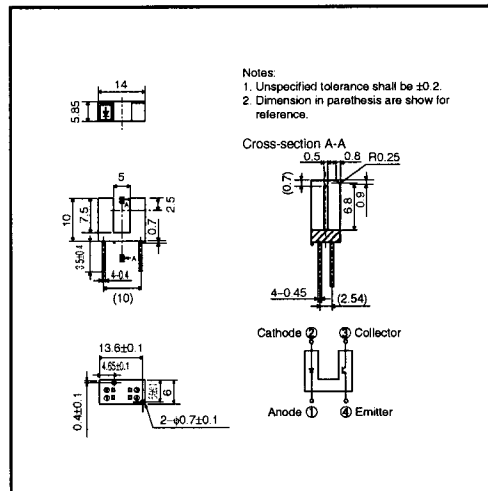

### ●Absolute maximum ratings (Ta = 25°C)

| Parameter                 |                             | Symbol    | Limits  | Unit |
|---------------------------|-----------------------------|-----------|---------|------|
| Input(LED)                | Forward current             | $I_F$     | 50      | mA   |
|                           | Reverse voltage             | $V_R$     | 5       | V    |
|                           | Power dissipation           | $P_D$     | 80      | mW   |
| Output (photo-transistor) | Collector-emitter voltage   | $V_{CEO}$ | 30      | V    |
|                           | Emitter-collector voltage   | $V_{ECO}$ | 4.5     | V    |
|                           | Collector current           | $I_C$     | 30      | mA   |
|                           | Collector power dissipation | $P_C$     | 80      | mW   |
| Operating temperature     |                             | $T_{opr}$ | -25~+85 | °C   |
| Storage temperature       |                             | $T_{stg}$ | -40~+85 | °C   |

Sensors

● Electrical and optical characteristics (Ta = 25°C)

|                          | Parameter                            | Symbol          | Min. | Typ. | Max. | Unit          | Conditions   |
|--------------------------|--------------------------------------|-----------------|------|------|------|---------------|--|
| Input characteristics    | Forward voltage                      | $V_F$           | -    | 1.3  | 1.6  | mV            | $I_F=50\text{mA}$                                  |
|                          | Reverse current                      | $I_R$           | -    | -    | 10   | $\mu\text{A}$ | $V_R=5\text{V}$                                    |
| Output characteristics   | Dark current                         | $I_{CEO}$       | -    | -    | 0.5  | $\mu\text{A}$ | $V_{CE}=10\text{V}$                                |
|                          | Peak sensitivity wavelength          | $\lambda_P$     | -    | 800  | -    | nm            | -  |
| Transfer characteristics | Collector current                    | $I_C$           | 0.5  | -    | -    | mA            | $V_{CE}=5\text{V}, I_F=20\text{mA}$                |
|                          | Collector-emitter saturation voltage | $V_{CE(sat)}$   | -    | 0.1  | 0.5  | V             | $I_F=20\text{mA}, I_C=0.5\text{mA}$                |
|                          | Response time                        | $t_r \cdot t_f$ | -    | 10   | -    | $\mu\text{s}$ | $V_{CC}=5\text{V}, I_F=20\text{mA}, R_L=100\Omega$ |

● Electrical and optical characteristic curves

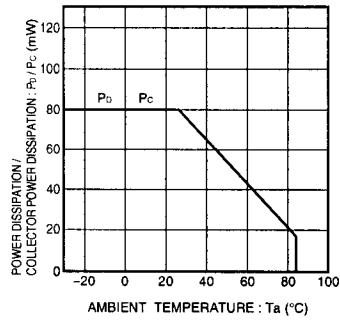

Fig.1 Power dissipation collector vs. ambient temperature

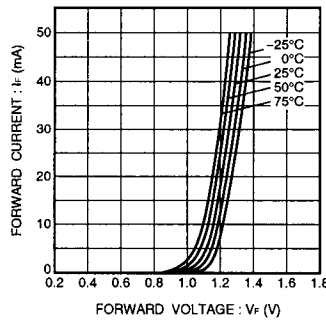

Fig.2 Forward current vs. forward voltage

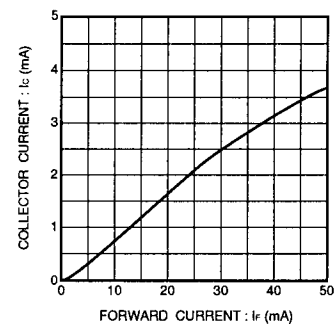

Fig.3 Collector current vs. forward current

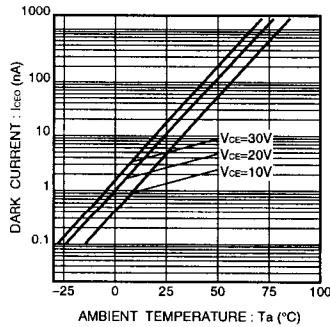

Fig.4 Dark current vs. ambient temperature

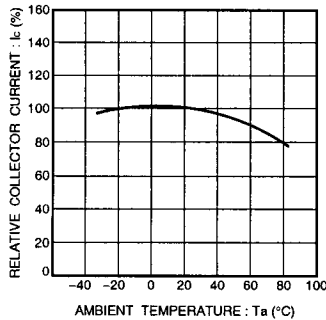

Fig.5 Relative output vs. ambient temperature

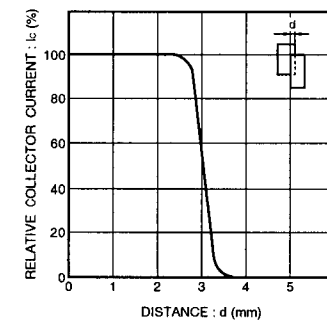

Fig.6 Relative output vs. distance characteristics