

# CoolMOS™ 1) Power MOSFET

Electrically isolated back surface  
 2500 V electrical isolation  
 N-Channel Enhancement Mode  
 Low  $R_{DS(on)}$ , high  $V_{DSS}$  MOSFET  
 Ultra low gate charge

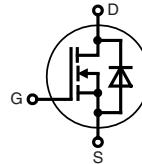

$$V_{DSS} = 600 \text{ V}$$

$$I_{D25} = 47 \text{ A}$$

$$R_{DS(on) \text{ max}} = 45 \text{ m}\Omega$$

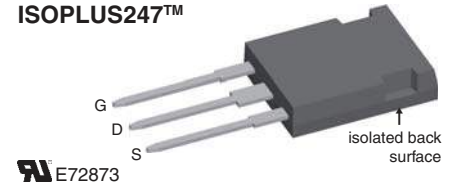
**ISOPLUS247™**

MOSFET			
Symbol	Conditions	Maximum Ratings	
$V_{DSS}$	$T_{VJ} = 25^\circ\text{C}$	600	V
$V_{GS}$		$\pm 20$	V
$I_{D25}$	$T_C = 25^\circ\text{C}$	47	A
$I_{D90}$	$T_C = 90^\circ\text{C}$	32	A
$E_{AS}$ $E_{AR}$	single pulse repetitive } $I_D = 11 \text{ A}; T_C = 25^\circ\text{C}$	1950 3	mJ mJ
$dV/dt$	MOSFET $dV/dt$ ruggedness $V_{DS} = 0 \dots 480 \text{ V}$	50	V/ns

## Features

- Silicon chip on Direct-Copper-Bond substrate
  - high power dissipation
  - isolated mounting surface
  - 2500 V electrical isolation
  - low drain to tab capacitance ( $< 30 \text{ pF}$ )
- Fast CoolMOS™ 1) power MOSFET 4<sup>th</sup> generation
  - high blocking capability
  - lowest resistance
  - avalanche rated for unclamped inductive switching (UIS)
  - low thermal resistance due to reduced chip thickness
- Enhanced total power density

## Applications

- Switched mode power supplies (SMPS)
- Uninterruptible power supplies (UPS)
- Power factor correction (PFC)
- Welding
- Inductive heating
- PDP and LCD adapter

## Advantages

- Easy assembly: no screws or isolation foils required
- Space savings
- High power density
- High reliability

<sup>1)</sup> CoolMOS™ is a trademark of Infineon Technologies AG.

Symbol	wiConditions	Characteristic Values			
		min.	typ.	max.	
$R_{DS(on)}$	$V_{GS} = 10 \text{ V}; I_D = 44 \text{ A}$		40	45	m $\Omega$
$V_{GS(th)}$	$V_{DS} = V_{GS}; I_D = 3 \text{ mA}$	2.5	3	3.5	V
$I_{DSS}$	$V_{DS} = V_{DSS}; V_{GS} = 0 \text{ V}$			10	$\mu\text{A}$
				50	$\mu\text{A}$
$I_{GSS}$	$V_{GS} = \pm 20 \text{ V}; V_{DS} = 0 \text{ V}$			100	nA
$C_{iss}$	} $V_{GS} = 0 \text{ V}; V_{DS} = 100 \text{ V}$ $f = 1 \text{ MHz}$		6800		pF
$C_{oss}$			320		pF
$Q_g$	} $V_{GS} = 0 \text{ to } 10 \text{ V}; V_{DS} = 400 \text{ V}; I_D = 44 \text{ A}$		150	190	nC
$Q_{gs}$			35		nC
$Q_{gd}$			50		nC
$t_{d(on)}$	} $V_{GS} = 10 \text{ V}; V_{DS} = 400 \text{ V}$ $I_D = 44 \text{ A}; R_G = 3.3 \Omega$		30		ns
$t_r$			20		ns
$t_{d(off)}$			100		ns
$t_f$			10		ns
$R_{thJC}$	with heatsink compound			0.45	K/W
$R_{thCH}$			0.25		K/W

**Source-Drain Diode**

Symbol	Conditions	Characteristic Values		
		min.	typ.	max.
( $T_{VJ} = 25^{\circ}\text{C}$ , unless otherwise specified)				
$I_S$	$V_{GS} = 0\text{ V}$		44	A
$V_{SD}$	$I_F = 44\text{ A}; V_{GS} = 0\text{ V}$	0.9	1.2	V
$t_{rr}$ $Q_{RM}$ $I_{RM}$	$I_F = 44\text{ A}; -di_F/dt = 100\text{ A}/\mu\text{s}; V_R = 400\text{ V}$	600		ns
		17		$\mu\text{C}$
		60		A

**Component**

Symbol	Conditions	Maximum Ratings	
$T_{VJ}$	operating	-55...+150	$^{\circ}\text{C}$
$T_{stg}$	storage	-55...+150	$^{\circ}\text{C}$
$V_{ISOL}$	$I_{ISOL} = 1\text{ mA}, 50/60\text{ Hz}, t = 1\text{ min}$	2500	V~
$F_C$	mounting force with clip	20-120	N

Symbol	Conditions	Characteristic Values		
		min.	typ.	max.
$C_P$	coupling capacity between shorted pins and mounting tab in the case		30	pF
$d_S, d_A$	pin - pin	tbd		mm
$d_S, d_A$	pin - backside metal	tbd		mm
Weight			6	g

### ISOPLUS247™ Outline

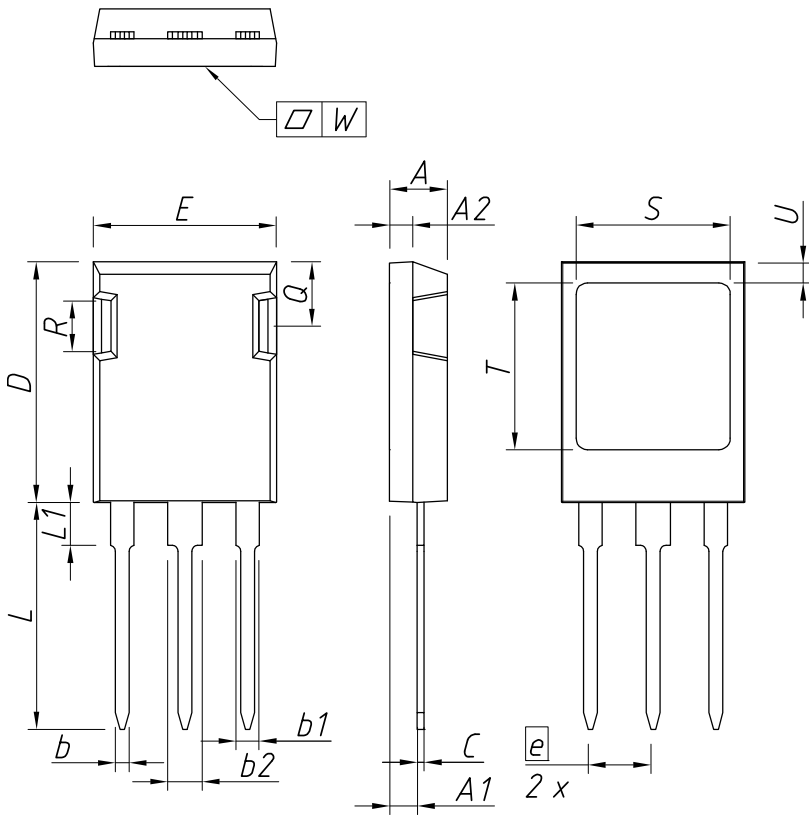

DIM.	MILLIMETER		INCHES	
	MIN	MAX	MIN	MAX
A	4,83	5,21	0,190	0,205
A1	2,29	2,54	0,090	0,100
A2	1,91	2,16	0,075	0,085
b	1,14	1,40	0,045	0,055
b1	1,91	2,15	0,075	0,085
b2	2,92	3,20	0,115	0,126
C	0,61	0,83	0,024	0,033
D	20,80	21,34	0,819	0,840
E	15,75	16,13	0,620	0,635
e	5,45 BSC		0,215 BSC	
L	19,81	20,60	0,780	0,811
L1	3,81	4,38	0,150	0,172
Q	5,59	6,20	0,220	0,244
R	4,32	4,85	0,170	0,191
S	13,21	13,72	0,520	0,540
T	15,75	16,26	0,620	0,640
U	1,65	2,03	0,065	0,080
W	-	0,10	-	0,004

Die konvexe Form des Substrates ist typ. < 0.04 mm über der Kunststoffoberfläche der Bauteilunterseite  
 The convex bow of substrate is typ. < 0.04 mm over plastic surface level of device bottom side

Die Gehäuseabmessungen entsprechen dem Typ TO-247 AD gemäß JEDEC außer Schraubloch und L<sub>max</sub>.  
 This drawing will meet all dimensions requirement of JEDEC outline TO-247 AD except screw hole and except L<sub>max</sub>.

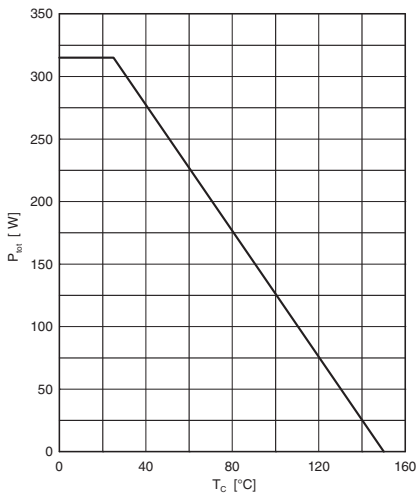

Fig. 1 Typ. power dissipation

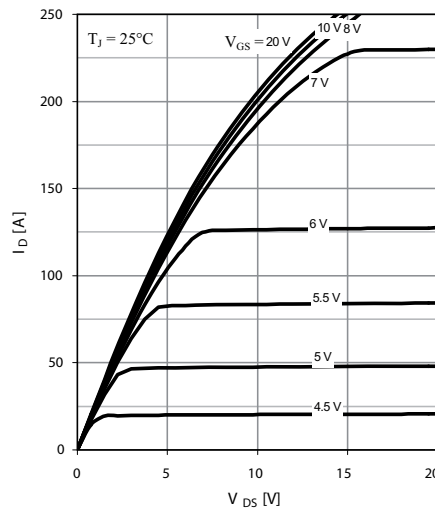

Fig. 2 Typ. output characteristics

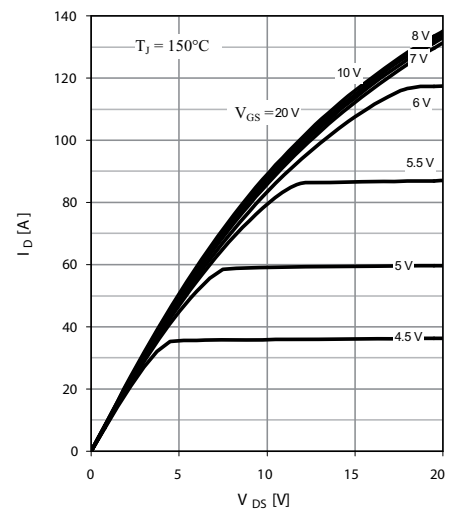

Fig. 3 Typ. output characteristics

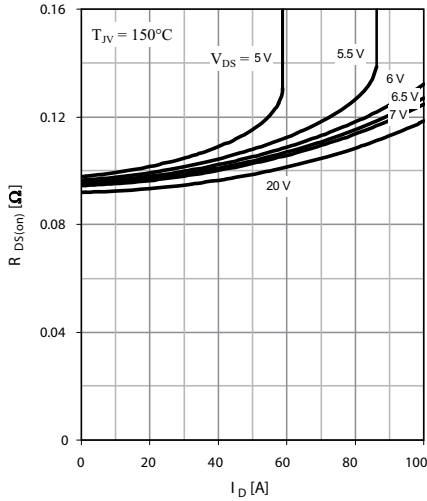

Fig. 4 Typ. drain-source on-state resistance

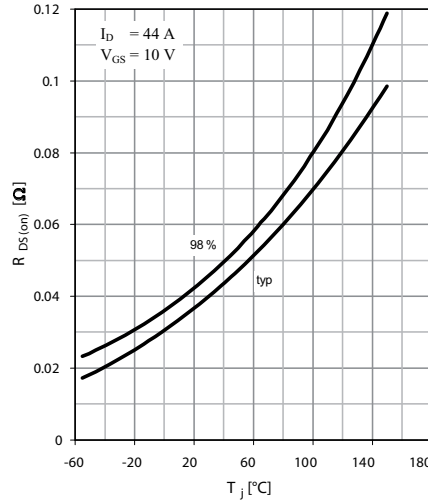

Fig. 5 Drain-source on-state resistance

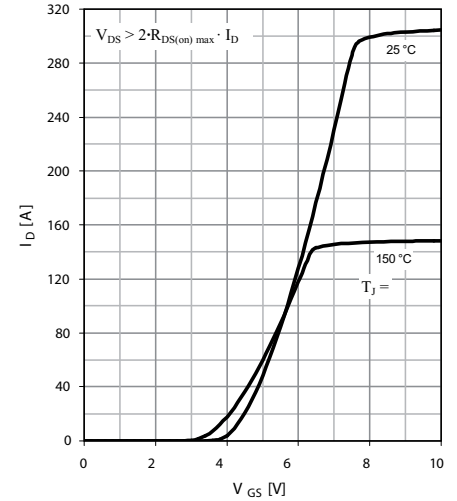

Fig. 6 Typ. transfer characteristics

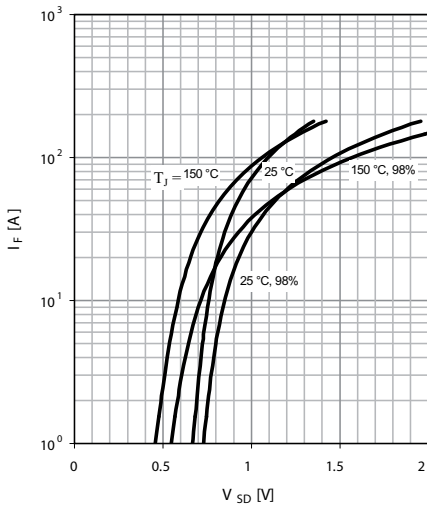

Fig. 7 Forward characteristic of reverse diode

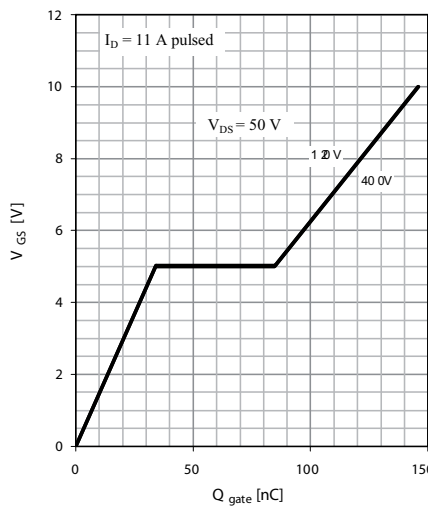

Fig. 8 Typ. gate charge

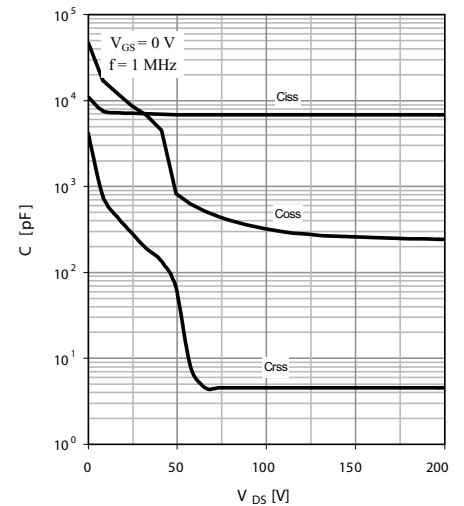

Fig. 9 Typ. capacitances

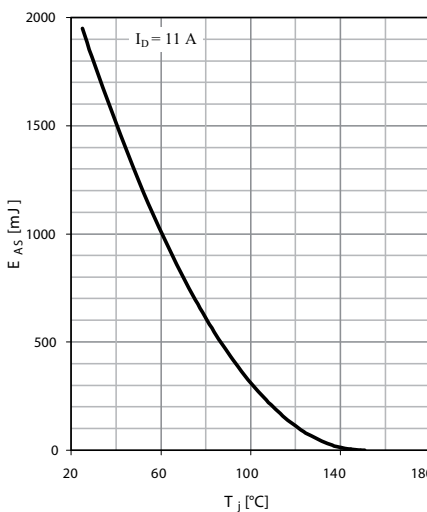

Fig. 9 Avalanche energy

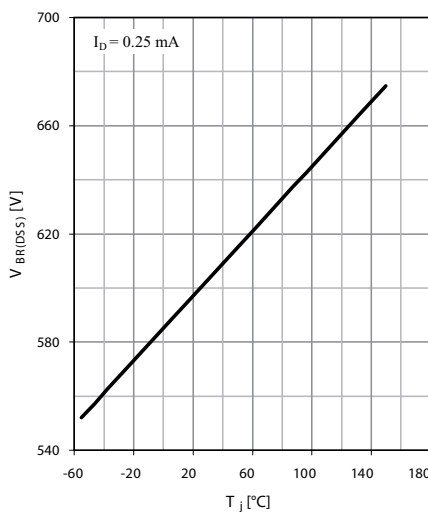

Fig. 10 Drain-source breakdown voltage

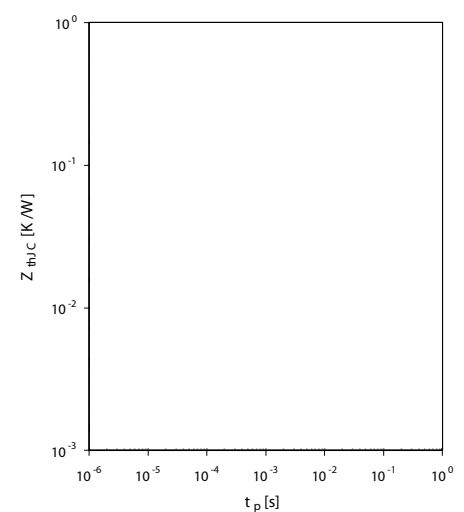

Fig. 12 Max. transient thermal impedance

IXYS reserves the right to change limits, test conditions and dimensions.

20080523b



---

Disclaimer Notice - Information furnished is believed to be accurate and reliable. However, users should independently evaluate the suitability of and test each product selected for their own applications. Littelfuse products are not designed for, and may not be used in, all applications. Read complete Disclaimer Notice at [www.littelfuse.com/disclaimer-electronics](http://www.littelfuse.com/disclaimer-electronics).