

GlobTek, Inc. www.globtek.com 186 Veterans Drive, Northvale, NJ 07647 Tel. (201) 784-1000 Fax (201) 784-0111	Drawing Title: GTM96300-3624-T3, Medical/ICT/ITE/Household use Power Supply, Efficiency Level: USA DOE Level VI / Eco-design Directive 2009/125/EC, (EU) 2019/1782, Case Color/Style: GlobTek Black, Desktop/External, Regulated Switchmode AC-DC Power Supply AC Adaptor, Input Rating: 100-240V~, 50-60 Hz, IEC 60320/C14 , Output Rating: 36W, 24.0V@1.5A, Output Configuration: 1500 mm, 18/1C + Shield Cond, UL 1185, Female Barrel 5.5*2.1*11mm WITH internal Spring Clip and Locking Notch or Equal, Ferrite: None, GlobTek Black, GT Cord # C26632, Pin Out: Center Positive (+V), symbol compliant with IEC 60417 symbol no. 5926, Blades/Input Cord: Not Applicable, Approvals: CCC (up to 48V only); LPS 60950; CAN ICES-3; CB 62368; CB 60950; ETL 1310; ETL; ETL; 230V CoC Tier 2; EAC; UKCA; LPS 62368; GEMS (12V); UL 1310; Conforms to 62368-1; ETL 62368; Morocco; S-Mark 62368; Singapore (5V); NOM (5V only); Korea (5, 5.4, 5.95, 7.5V Only); India BIS (5,5.95,7.5,9,12,15,24,30,36 and 48V); Taiwan BSMI (5,5.4,5.95,7.5,9,12,15,18,19,24,30,36,48V only); IRAM (pending); South Africa; South Africa (pending); S-Mark 60950; RCM; CE; CE; CB 60335; S-Mark IEC/EN 60601-1; WEEE; VCCI; Ukraine;RoHS; Level VI; China RoHS; CE; PSE; PSE; PSE; CB 60601-1;	
	Model No. GTM96300-3624-T3	
	Part No./Ordering No. TR9CI1500CCPIMR6B	Rev C1

In Addition to GlobTek Inc.'s renewed ISO9001:2015 - Quality Management System Certification, GlobTek Inc. is now certified to:

ISO13485:2016 - Medical Devices Quality Management System Certification

ISO14001:2015 - Environmental Management System Certification

ISO Certificates are available online at <https://www.globtek.com/iso-certificates/>

The acceptance of this specification and use of the product described in this document indicates the acceptance and binding of the customer to Globtek TERMS AND CONDITIONS (attached to the end of this document), which supersede all other agreements, terms, and conditions (<https://en.globtek.com/terms-and-conditions/>).

The purchaser of this product (Customer) agrees that it is their sole responsibility to determine suitability/fitness of the product described in this specification for their application and to take precautions for protection against any hazards attendant to the handling and use of the product.

Footnote:

GlobTek Inc. will not be liable for the safety and performance of these power supplies/battery packs if unauthorized access and repair occurs. End user should consult applicable UL, CSA or EN standards for proper installation instruction.

Limitation of Use:

GlobTek products are intended for use with commercial, medical, and/or industrial equipment only. GlobTek product are not authorized for use as mission critical components in life support hazardous environment, nuclear or aircraft applications without prior written approval from the CEO of GlobTek Inc.

Contents of this document are subject to change without prior notice.

Customer Approval of Specification:

Please approve, sign and send back to GlobTek so we can complete order processing.

A delay in receipt of this form will delay delivery schedule.

Company Name:	Customer P/N:
Quote Number:	Date:
Authorized Representative Name:	Authorized Representative Signature:

GlobTek, Inc. www.globtek.com 186 Veterans Drive, Northvale, NJ 07647 Tel. (201) 784-1000 Fax (201) 784-0111	Drawing Title: GTM96300-3624-T3, Medical/ICT/ITE/Household use Power Supply, Efficiency Level: USA DOE Level VI / Eco-design Directive 2009/125/EC, (EU) 2019/1782, Case Color/Style: GlobTek Black, Desktop/External, Regulated Switchmode AC-DC Power Supply AC Adaptor, Input Rating: 100-240V~, 50-60 Hz, IEC 60320/C14 , Output Rating: 36W, 24.0V@1.5A, Output Configuration: 1500 mm, 18/1C + Shield Cond, UL 1185, Female Barrel 5.5*2.1*11mm WITH internal Spring Clip and Locking Notch or Equal, Ferrite: None, GlobTek Black, GT Cord # C26632, Pin Out: Center Positive (+V), symbol compliant with IEC 60417 symbol no. 5926, Blades/Input Cord: Not Applicable, Approvals: CCC (up to 48V only); LPS 60950; CAN ICES-3; CB 62368; CB 60950; ETL 1310; ETL; ETL; 230V CoC Tier 2; EAC; UKCA; LPS 62368; GEMS (12V); UL 1310; Conforms to 62368-1; ETL 62368; Morocco; S-Mark 62368; Singapore (5V); NOM (5V only); Korea (5, 5.4, 5.95, 7.5V Only); India BIS (5,5.95,7.5,9,12,15,24,30,36 and 48V); Taiwan BSMI (5,5.4,5.95,7.5,9,12,15,18,19,24,30,36,48V only); IRAM (pending); South Africa; South Africa (pending); S-Mark 60950; RCM; CE; CE; CB 60335; S-Mark IEC/EN 60601-1; WEEE; VCCI; Ukraine;RoHS; Level VI; China RoHS; CE; PSE; PSE; PSE; CB 60601-1;	
	Model No. GTM96300-3624-T3	
	Part No./Ordering No. TR9CI1500CCPIMR6B	Rev C1

REVISION HISTORY

REV	DESCRIPTION	SUB	DATE	APPROVED
C1	Update label specs to ISO 15223 medical device compliant label, add Morocco, UKCA approvals Update packing to 60pcs, change egg to gift box 142*62*60 mm	QA	09/24/2021	QA
C	Update Output connector Female barrel 5.5*2.1*11 mm with spring clip and locking notch	QA	06/04/2019	QA
B	Update Grounding configuration to F2	QA	11/30/2018	QA
A	Initial release	QA	05/18/2018	QA

POWER SUPPLY INFORMATION

TYPE	Desktop/External
TECHNOLOGY	Regulated Switchmode AC-DC Power Supply AC Adaptor
CASE COLOR	GlobTek Black
NAMEPLATE RATED INPUT	100-240V~, 50-60 Hz, 1.0A
INPUT CONFIG	IEC 60320/C14
WATTS	36.00
VOLTS OUT	24.0
CURRENT OUT (Amps)	1.5
BLADE/CORD INCLUDED	N/A Not Applicable
BLADE/CORD INSTALLED	N/A :Not Applicable
INGRESS PROTECTION	IP42, IP54 Option available
GROUNDING CONFIGURATION	(F2) Isolated Functional Earth for GTM96 series, Improved EMC
EFFICIENCY LEVEL	USA DOE Level VI / Eco-design Directive 2009/125/EC, (EU) 2019/1782 - Europe Code of Conduct on Energy Efficiency of External Power Supplies - Version 5
OUTPUT CONFIGURATION	1500 mm, 18/1C + Shield Cond, UL 1185, Female Barrel 5.5*2.1*11mm WITH internal Spring Clip and Locking Notch or Equal, Ferrite: None, GlobTek Black, GT Cord # C26632
OVERMOLDED	Yes
OUTPUT CONNECTOR GENDER	Female
CONNECTOR PIN OUT	Center Positive (+V), symbol compliant with IEC 60417 symbol no. 5926
LABEL SPECS	ISO 15223 medical device compliant label,L-1470
SPECIAL BARCODE LABEL MATERIAL	No
PACK SPEC	Standard DT, Individually Box, GT User Manual
USER MANUAL	809-DESKTOPUSERMANUAL on A4 paper

PROPRIETARY INFORMATION

PROPRIETARY OF GLOBTEK, INC. ANY REPRODUCTION, DISCLOSURE OR USE OF THIS DRAWING, IN WHOLE OR IN PART, IS HEREBY PROHIBITED EXCEPT AS SPECIFIED IN

WRITING BY GLOBTEK, INC. © GlobTek, Inc. 2018 - 2023

quest / 08/08/2023 6:17:57 AM GMT CLONED FROM RR9KI1500CCPIMNAR6B

GlobTek, Inc. www.globtek.com 186 Veterans Drive, Northvale, NJ 07647 Tel. (201) 784-1000 Fax (201) 784-0111	Drawing Title: GTM96300-3624-T3, Medical/ICT/ITE/Household use Power Supply, Efficiency Level: USA DOE Level VI / Eco-design Directive 2009/125/EC, (EU) 2019/1782, Case Color/Style: GlobTek Black, Desktop/External, Regulated Switchmode AC-DC Power Supply AC Adaptor, Input Rating: 100-240V~, 50-60 Hz, IEC 60320/C14 , Output Rating: 36W, 24.0V@1.5A, Output Configuration: 1500 mm, 18/1C + Shield Cond, UL 1185, Female Barrel 5.5*2.1*11mm WITH internal Spring Clip and Locking Notch or Equal, Ferrite: None, GlobTek Black, GT Cord # C26632, Pin Out: Center Positive (+V), symbol compliant with IEC 60417 symbol no. 5926, Blades/Input Cord: Not Applicable, Approvals: CCC (up to 48V only); LPS 60950; CAN ICES-3; CB 62368; CB 60950; ETL 1310; ETL; ETL; 230V CoC Tier 2; EAC; UKCA; LPS 62368; GEMS (12V); UL 1310; Conforms to 62368-1; ETL 62368; Morocco; S-Mark 62368; Singapore (5V); NOM (5V only); Korea (5, 5.4, 5.95, 7.5V Only); India BIS (5,5.95,7.5,9,12,15,24,30,36 and 48V); Taiwan BSMI (5,5.4,5.95,7.5,9,12,15,18,19,24,30,36,48V only); IRAM (pending); South Africa; South Africa (pending); S-Mark 60950; RCM; CE; CE; CB 60335; S-Mark IEC/EN 60601-1; WEEE; VCCI; Ukraine;RoHS; Level VI; China RoHS; CE; PSE; PSE; PSE; CB 60601-1;	
	Model No. GTM96300-3624-T3	
	Part No./Ordering No. TR9CI1500CCPIMR6B	Rev C1

Notes/Modifications/Customizations (notes in this section supersede the values shown in the standard spec)

DIMENSIONS ARE IN MM UNLESS SPECIFIED OTHERWISE

GlobTek, Inc. www.globtek.com 186 Veterans Drive, Northvale, NJ 07647 Tel. (201) 784-1000 Fax (201) 784-0111	Drawing Title: GTM96300-3624-T3, Medical/ICT/ITE/Household use Power Supply, Efficiency Level: USA DOE Level VI / Eco-design Directive 2009/125/EC, (EU) 2019/1782, Case Color/Style: GlobTek Black, Desktop/External, Regulated Switchmode AC-DC Power Supply AC Adaptor, Input Rating: 100-240V~, 50-60 Hz, IEC 60320/C14 , Output Rating: 36W, 24.0V@1.5A, Output Configuration: 1500 mm, 18/1C + Shield Cond, UL 1185, Female Barrel 5.5*2.1*11mm WITH internal Spring Clip and Locking Notch or Equal, Ferrite: None, GlobTek Black, GT Cord # C26632, Pin Out: Center Positive (+V), symbol compliant with IEC 60417 symbol no. 5926, Blades/Input Cord: Not Applicable, Approvals: CCC (up to 48V only); LPS 60950; CAN ICES-3; CB 62368; CB 60950; ETL 1310; ETL; ETL; 230V CoC Tier 2; EAC; UKCA; LPS 62368; GEMS (12V); UL 1310; Conforms to 62368-1; ETL 62368; Morocco; S-Mark 62368; Singapore (5V); NOM (5V only); Korea (5, 5.4, 5.95, 7.5V Only); India BIS (5,5.95,7.5,9,12,15,24,30,36 and 48V); Taiwan BSMI (5,5.4,5.95,7.5,9,12,15,18,19,24,30,36,48V only); IRAM (pending); South Africa; South Africa (pending); S-Mark 60950; RCM; CE; CE; CB 60335; S-Mark IEC/EN 60601-1; WEEE; VCCI; Ukraine;RoHS; Level VI; China RoHS; CE; PSE; PSE; PSE; CB 60601-1;	
	Model No. GTM96300-3624-T3	
	Part No./Ordering No. TR9CI1500CCPIMR6B	Rev C1

ELECTRICAL SPECIFICATIONS

A) ELECTRICAL SPECIFICATIONS:

01. Input Voltage: Specified 90-264 Vac, Nameplate rated: 100-240Vac
 - 90-264 Vac range @ 100% of rated load current
 - 85-264 Vac range @ 85% of rated load current
 - 110-370 VDC range @ 100% of rated load current
02. Input Frequency: Specified 47-63 Hz, Nameplate rated 50-60Hz
03. Output Regulation: +/- 5% measured at the output connector
04. Line Voltage Regulation: +/- 0.5% typical measured at full load
05. Output Ripple (Vp-p): 1% or 100 mV whichever is greater, measured at 20 MHz bandwidth with 0.1 uf ceramic capacitor in parallel with a low impedance 47 uf electrolytic capacitor connected at the end of the output connector
06. Turn-ON/OFF Overshoot: 5% maximum, 1 mS typical recovery time for 40% to 70% step load
07. Turn-ON Delay: 1 second maximum @ full load, nominal line
08. Hold-Up Time: 8 mS typical @ nominal input voltage and full load
09. Inrush Current: 30A/60A maximum cold start @ 115/230Vac input
10. Efficiency: Compliant with Efficiency Level VI and CoC Tier 2 standards
11. No Load Standby Power: <0.075 W @ 230Vac

B) PROTECTION

01. Input Protection: Input line fusing and 300Vac MOV
02. Short Circuit/ Overload: Electronically Protected unit will auto recover upon removal of fault
 - Output Current Limit: 110% to 160% of rated output current
 - (upper end of current limit range is determined by normal output power rating, not derated output power level)
03. Output Over-Voltage: 110% to 130% of nominal output voltage

C) SAFETY

01. Dielectric Withstand Voltage: 4000Vac or 5656Vdc from input to output, On Class I models, 3000Vac or 4242Vdc from input to earth
02. Earth Leakage Current: Class I models < 300uA, N/A for Class II models
03. Touch Current: Class I models < 20uA, Class II models < 75uA
04. Earth Continuity Test: < 0.1 Ohm between Earth Pin at AC input and PCB termination point (Class I models only)
05. Means of Protection: 2 x MOPP
06. Compliant Standards: See listings at end of this drawing for specifics
07. [Output Isolation Options:](#)
 - a) C8 or C18 Inlet, Class II
 - b) C6 or C14 Inlet, Class II FE, Output Isolated from Earth contact
 - c) C6 or C14 Inlet, Class I, Output negative directly attached to Earth contact

D) EMC

- EN 60601-1-2, 4th edition
- Emissions, per EN 55032, EN 61000-6-3, EN 61000-6-4, CISPR11 and CISPR22
- Conducted Emissions: Class B, FCC Part 15, Class B
 - Radiated Emissions: Class B, FCC Part 15, Class B
 - Line Frequency Harmonics EN61000-3-2, Class A

PROPRIETARY INFORMATION

PROPRIETARY OF GLOBTEK, INC. ANY REPRODUCTION, DISCLOSURE OR USE OF THIS DRAWING, IN WHOLE OR IN PART, IS HEREBY PROHIBITED EXCEPT AS SPECIFIED IN WRITING BY GLOBTEK, INC. © GlobTek, Inc. 2018 - 2023

<p>GlobTek, Inc. www.globtek.com 186 Veterans Drive, Northvale, NJ 07647 Tel. (201) 784-1000 Fax (201) 784-0111</p>	<p>Drawing Title: GTM96300-3624-T3, Medical/ICT/ITE/Household use Power Supply, Efficiency Level: USA DOE Level VI / Eco-design Directive 2009/125/EC, (EU) 2019/1782, Case Color/Style: GlobTek Black, Desktop/External, Regulated Switchmode AC-DC Power Supply AC Adaptor, Input Rating: 100-240V~, 50-60 Hz, IEC 60320/C14, Output Rating: 36W, 24.0V@1.5A, Output Configuration: 1500 mm, 18/1C + Shield Cond, UL 1185, Female Barrel 5.5*2.1*11mm WITH internal Spring Clip and Locking Notch or Equal, Ferrite: None, GlobTek Black, GT Cord # C26632, Pin Out: Center Positive (+V), symbol compliant with IEC 60417 symbol no. 5926, Blades/Input Cord: Not Applicable, Approvals: CCC (up to 48V only); LPS 60950; CAN ICES-3; CB 62368; CB 60950; ETL 1310; ETL; ETL; 230V CoC Tier 2; EAC; UKCA; LPS 62368; GEMS (12V); UL 1310; Conforms to 62368-1; ETL 62368; Morocco; S-Mark 62368; Singapore (5V); NOM (5V only); Korea (5, 5.4, 5.95, 7.5V Only); India BIS (5,5.95,7.5,9,12,15,24,30,36 and 48V); Taiwan BSMI (5,5.4,5.95,7.5,9,12,15,18,19,24,30,36,48V only); IRAM (pending); South Africa; South Africa (pending); S-Mark 60950; RCM; CE; CE; CB 60335; S-Mark IEC/EN 60601-1; WEEE; VCCI; Ukraine;RoHS; Level VI; China RoHS; CE; PSE; PSE; PSE; CB 60601-1;</p>	
	<p>Model No. GTM96300-3624-T3</p>	
	<p>Part No./Ordering No. TR9CI1500CCPIMR6B</p>	<p>Rev C1</p>

Voltage Fluctuations/Flicker EN61000-3-3

Immunity, per EN 55024, EN 61000-6-1, EN 61000-6-2

Static Discharge Immunity EN61000-4-2, 10kV Contact Discharge, 20kV air discharge

Radiated RF Immunity EN61000-4-3, 10V/m 80-1000MHz, 3V/m 1-2.7GHz, 80% 1KHz AM.

EFT/Burst Immunity EN61000-4-4, 4kV/100kHz.

Line Surge Immunity EN61000-4-5, 2kV differential, 4kV common-mode

Conducted RF Immunity EN61000-4-6, 3Vrms, 80% 1KHz AM

Power Frequency Magnetic Field Immunity EN61000-4-8, 3A/m

Voltage Dip Immunity EN61000-4-11, Performance Criteria B/C

E) OTHER:

01. MTBF: 1,000,000 Hours @ 40°C ambient temperature, Full Load

02. GTM96300 Family: -10°C to 40°C ambient temperature with full load

Regarding Operating Temperature,

a- See below derating table for output power capability at alternate temperature

b- Extended low end temperature range available as custom option

03. Operating Humidity: 0% to 95% relative humidity, non-condensing

04. Storage Temperature: -30°C to 80°C

05. Operating Altitude: 5000 Meters

06. ROHS: Compliant with latest regulations, see approvals section below

F) ENCLOSURE

01. Housing: High impact plastic, 94V0 polycarbonate, non-vented

02. Markings: Label or Laser Printed

03. AC Input mechanical options: Desktop C6, C8, C14 or C18 IEC Inlet.

Hybrid option (Desktop or Changeable Blade Wall Plug-in) Class I or Class II input

G) SPECIAL OPTIONS

01. Cost reduction, removal of LED

02. Custom Cordsets, various cordage types, and connector types

03. Custom Markings

04. Short term Output Surge Capability

05. Reduced Leakage Current versions

06. Tightened output voltage tolerance

07. Reduced output ripple level

08. Reduced output power rating marking

09. High Rel PCB laminate with Plated through Holes for IPC610 Class 2 Compliance

10. Special Housing Colors and Cordset Colors

<p>GlobTek, Inc. www.globtek.com 186 Veterans Drive, Northvale, NJ 07647 Tel. (201) 784-1000 Fax (201) 784-0111</p>	Drawing Title: GTM96300-3624-T3, Medical/ICT/ITE/Household use Power Supply, Efficiency Level: USA DOE Level VI / Eco-design Directive 2009/125/EC, (EU) 2019/1782, Case Color/Style: GlobTek Black, Desktop/External, Regulated Switchmode AC-DC Power Supply AC Adaptor, Input Rating: 100-240V~, 50-60 Hz, IEC 60320/C14 , Output Rating: 36W, 24.0V@1.5A, Output Configuration: 1500 mm, 18/1C + Shield Cond, UL 1185, Female Barrel 5.5*2.1*11mm WITH internal Spring Clip and Locking Notch or Equal, Ferrite: None, GlobTek Black, GT Cord # C26632, Pin Out: Center Positive (+V), symbol compliant with IEC 60417 symbol no. 5926, Blades/Input Cord: Not Applicable, Approvals: CCC (up to 48V only); LPS 60950; CAN ICES-3; CB 62368; CB 60950; ETL 1310; ETL; ETL; 230V CoC Tier 2; EAC; UKCA; LPS 62368; GEMS (12V); UL 1310; Conforms to 62368-1; ETL 62368; Morocco; S-Mark 62368; Singapore (5V); NOM (5V only); Korea (5, 5.4, 5.95, 7.5V Only); India BIS (5,5.95,7.5,9,12,15,24,30,36 and 48V); Taiwan BSMI (5,5.4,5.95,7.5,9,12,15,18,19,24,30,36,48V only); IRAM (pending); South Africa; South Africa (pending); S-Mark 60950; RCM; CE; CE; CB 60335; S-Mark IEC/EN 60601-1; WEEE; VCCI; Ukraine;RoHS; Level VI; China RoHS; CE; PSE; PSE; PSE; CB 60601-1;	
	Model No. GTM96300-3624-T3	
	Part No./Ordering No. TR9CI1500CCPIMR6B	Rev C1

- 11. Quasi Constant Current Output, for Battery Charger Applications
- 12. Back EMF applications, custom solutions. For unusual motor load aps and other high inductance reverse energy flow requirements
- 13. Improved Ingress Protection Rating

TO ADDRESS SYSTEM-LEVEL EMI CONCERNS, FERRITE CHOKES/BEADS MAY BE ADDED/REVISED UPON REQUEST. A SAMPLE KIT OF GLOBTEK'S STANDARD FERRITES IS AVAILABLE UNDER GLOBTEK P/N: EMI-MITIGATION-KIT1

FOR ADDITIONAL INFORMATION, PLEASE READ OUR WHITE PAPER AT: <https://r.globtek.info/3QeaqtD>

INGRESS PROTECTION: IP42, IP54 Option available

GlobTek, Inc. www.globtek.com 186 Veterans Drive, Northvale, NJ 07647 Tel. (201) 784-1000 Fax (201) 784-0111	Drawing Title: GTM96300-3624-T3, Medical/ICT/ITE/Household use Power Supply, Efficiency Level: USA DOE Level VI / Eco-design Directive 2009/125/EC, (EU) 2019/1782, Case Color/Style: GlobTek Black, Desktop/External, Regulated Switchmode AC-DC Power Supply AC Adaptor, Input Rating: 100-240V~, 50-60 Hz, IEC 60320/C14 , Output Rating: 36W, 24.0V@1.5A, Output Configuration: 1500 mm, 18/1C + Shield Cond, UL 1185, Female Barrel 5.5*2.1*11mm WITH internal Spring Clip and Locking Notch or Equal, Ferrite: None, GlobTek Black, GT Cord # C26632, Pin Out: Center Positive (+V), symbol compliant with IEC 60417 symbol no. 5926, Blades/Input Cord: Not Applicable, Approvals: CCC (up to 48V only); LPS 60950; CAN ICES-3; CB 62368; CB 60950; ETL 1310; ETL; ETL; 230V CoC Tier 2; EAC; UKCA; LPS 62368; GEMS (12V); UL 1310; Conforms to 62368-1; ETL 62368; Morocco; S-Mark 62368; Singapore (5V); NOM (5V only); Korea (5, 5.4, 5.95, 7.5V Only); India BIS (5,5.95,7.5,9,12,15,24,30,36 and 48V); Taiwan BSMI (5,5.4,5.95,7.5,9,12,15,18,19,24,30,36,48V only); IRAM (pending); South Africa; South Africa (pending); S-Mark 60950; RCM; CE; CE; CB 60335; S-Mark IEC/EN 60601-1; WEEE; VCCI; Ukraine;RoHS; Level VI; China RoHS; CE; PSE; PSE; PSE; CB 60601-1;	
	Model No. GTM96300-3624-T3	
	Part No./Ordering No. TR9CI1500CCPIMR6B	Rev C1

3D File Download <https://www.globtek.com/dl/GTM96300-T3%20without%20a%20waterproof%20barrier.igs>

Mechanical drawing

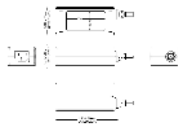

Alternative housing with waterproof barrier. Product PN# ends with suffix "RG"



GlobTek, Inc.
 www.globtek.com
 186 Veterans Drive,
 Northvale, NJ 07647
 Tel. (201) 784-1000
 Fax (201) 784-0111

Drawing Title: GTM96300-3624-T3, Medical/ICT/ITE/Household use Power Supply, Efficiency Level: USA DOE Level VI / Eco-design Directive 2009/125/EC, (EU) 2019/1782, Case Color/Style: GlobTek Black, Desktop/External, Regulated Switchmode AC-DC Power Supply AC Adaptor, Input Rating: 100-240V~, 50-60 Hz, IEC 60320/C14, Output Rating: 36W, 24.0V@1.5A, Output Configuration: 1500 mm, 18/1C + Shield Cond, UL 1185, Female Barrel 5.5*2.1*11mm WITH internal Spring Clip and Locking Notch or Equal, Ferrite: None, GlobTek Black, GT Cord # C26632, Pin Out: Center Positive (+V), symbol compliant with IEC 60417 symbol no. 5926, Blades/Input Cord: Not Applicable, Approvals: CCC (up to 48V only); LPS 60950; CAN ICES-3; CB 62368; CB 60950; ETL 1310; ETL; ETL; 230V CoC Tier 2; EAC; UKCA; LPS 62368; GEMS (12V); UL 1310; Conforms to 62368-1; ETL 62368; Morocco; S-Mark 62368; Singapore (5V); NOM (5V only); Korea (5, 5.4, 5.95, 7.5V Only); India BIS (5,5.95,7.5,9,12,15,24,30,36 and 48V); Taiwan BSMI (5,5.4,5.95,7.5,9,12,15,18,19,24,30,36,48V only); IRAM (pending); South Africa; South Africa (pending); S-Mark 60950; RCM; CE; CE; CB 60335; S-Mark IEC/EN 60601-1; WEEE; VCCI; Ukraine;RoHS; Level VI; China RoHS; CE; PSE; PSE; PSE; CB 60601-1;

Model No. GTM96300-3624-T3

Part No./Ordering No. TR9CI1500CCPIMR6B

Rev C1

DERATING CURVE

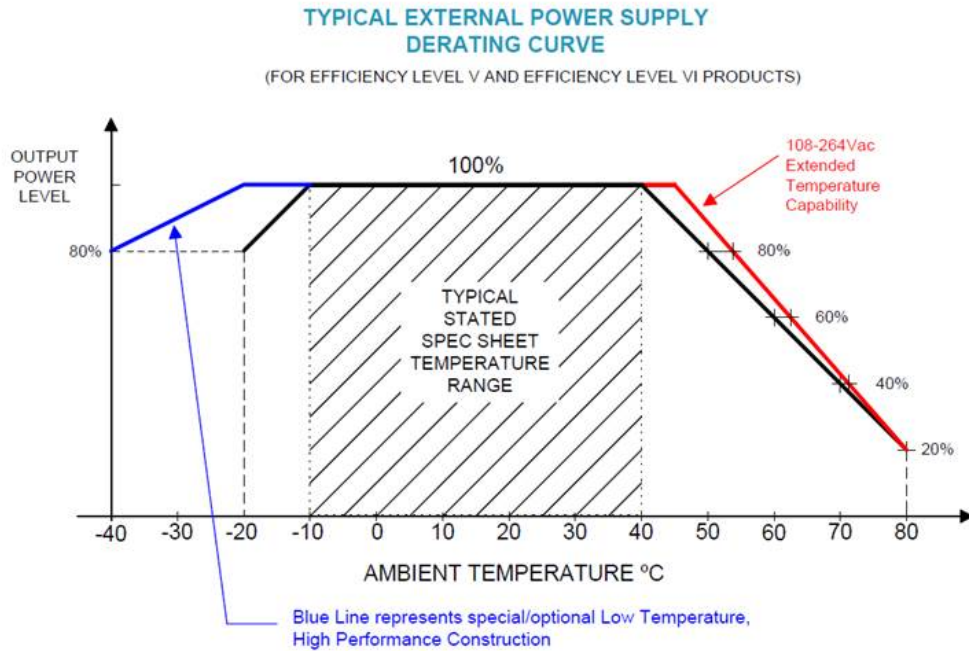

<p>GlobTek, Inc. www.globtek.com 186 Veterans Drive, Northvale, NJ 07647 Tel. (201) 784-1000 Fax (201) 784-0111</p>	<p>Drawing Title: GTM96300-3624-T3, Medical/ICT/ITE/Household use Power Supply, Efficiency Level: USA DOE Level VI / Eco-design Directive 2009/125/EC, (EU) 2019/1782, Case Color/Style: GlobTek Black, Desktop/External, Regulated Switchmode AC-DC Power Supply AC Adaptor, Input Rating: 100-240V~, 50-60 Hz, IEC 60320/C14 , Output Rating: 36W, 24.0V@1.5A, Output Configuration: 1500 mm, 18/1C + Shield Cond, UL 1185, Female Barrel 5.5*2.1*11mm WITH internal Spring Clip and Locking Notch or Equal, Ferrite: None, GlobTek Black, GT Cord # C26632, Pin Out: Center Positive (+V), symbol compliant with IEC 60417 symbol no. 5926, Blades/Input Cord: Not Applicable, Approvals: CCC (up to 48V only); LPS 60950; CAN ICES-3; CB 62368; CB 60950; ETL 1310; ETL; ETL; 230V CoC Tier 2; EAC; UKCA; LPS 62368; GEMS (12V); UL 1310; Conforms to 62368-1; ETL 62368; Morocco; S-Mark 62368; Singapore (5V); NOM (5V only); Korea (5, 5.4, 5.95, 7.5V Only); India BIS (5,5.95,7.5,9,12,15,24,30,36 and 48V); Taiwan BSMI (5,5.4,5.95,7.5,9,12,15,18,19,24,30,36,48V only); IRAM (pending); South Africa; South Africa (pending); S-Mark 60950; RCM; CE; CE; CB 60335; S-Mark IEC/EN 60601-1; WEEE; VCCI; Ukraine;RoHS; Level VI; China RoHS; CE; PSE; PSE; PSE; CB 60601-1;</p>	
	<p>Model No. GTM96300-3624-T3</p>	
	<p>Part No./Ordering No. TR9CI1500CCPIMR6B</p>	<p>Rev C1</p>

INPUT CONFIGURATION

(F2) Isolated Functional Earth for GTM96 series, Improved EMC

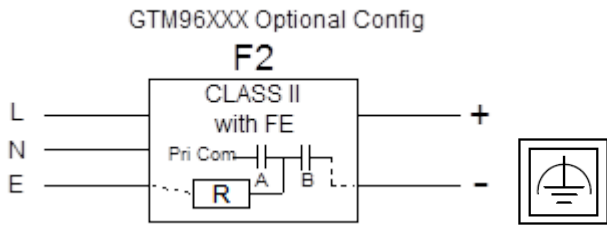

[Alternate grounding configurations](#) available upon request.

Blades/Cord Included:N/A:Not Applicable

Blades/Cord Installed:N/A:Not Applicable

IEC 60320/C14 AC Inlet Connector, Class I, Earth Ground

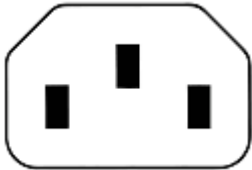

Mates with IEC 60320/C13 Plug

Optional Locking IEC60320 Receptacle and cord option available on some models by request.:



[Standard International IEC 320/C13 Cordsets](#)

Below are standard cordsets which are "not included" (unless stated above); these can be purchased separately or packaged with the power supply. Contact your Sales Engineer if the style required is not shown below. Many more available in different lengths, colors or cable material.

<p>GlobTek, Inc. www.globtek.com 186 Veterans Drive, Northvale, NJ 07647 Tel. (201) 784-1000 Fax (201) 784-0111</p>	<p>Drawing Title: GTM96300-3624-T3, Medical/ICT/ITE/Household use Power Supply, Efficiency Level: USA DOE Level VI / Eco-design Directive 2009/125/EC, (EU) 2019/1782, Case Color/Style: GlobTek Black, Desktop/External, Regulated Switchmode AC-DC Power Supply AC Adaptor, Input Rating: 100-240V~, 50-60 Hz, IEC 60320/C14, Output Rating: 36W, 24.0V@1.5A, Output Configuration: 1500 mm, 18/1C + Shield Cond, UL 1185, Female Barrel 5.5*2.1*11mm WITH internal Spring Clip and Locking Notch or Equal, Ferrite: None, GlobTek Black, GT Cord # C26632, Pin Out: Center Positive (+V), symbol compliant with IEC 60417 symbol no. 5926, Blades/Input Cord: Not Applicable, Approvals: CCC (up to 48V only); LPS 60950; CAN ICES-3; CB 62368; CB 60950; ETL 1310; ETL; ETL; 230V CoC Tier 2; EAC; UKCA; LPS 62368; GEMS (12V); UL 1310; Conforms to 62368-1; ETL 62368; Morocco; S-Mark 62368; Singapore (5V); NOM (5V only); Korea (5, 5.4, 5.95, 7.5V Only); India BIS (5,5.95,7.5,9,12,15,24,30,36 and 48V); Taiwan BSMI (5,5.4,5.95,7.5,9,12,15,18,19,24,30,36,48V only); IRAM (pending); South Africa; South Africa (pending); S-Mark 60950; RCM; CE; CE; CB 60335; S-Mark IEC/EN 60601-1; WEEE; VCCI; Ukraine;RoHS; Level VI; China RoHS; CE; PSE; PSE; PSE; CB 60601-1;</p>	
	<p>Model No. GTM96300-3624-T3</p>	
	<p>Part No./Ordering No. TR9CI1500CCPIMR6B</p>	<p>Rev C1</p>

Stock Power Supply Cords

Part Number/ Link	Country	Plug	Termination	Length (mm)	(Ft)
3021457F701(R)	N. American (Type B)	NEMA 5-15P	IEC 320/C13	2150	7
1191068F0701(R)	N. American (Type B)	NEMA 5-15P Hospital	IEC 320/C13	2459	8
2194272M5701-T(R)	Argentina (Type I)	IRAM 2073	IEC 320/C13	2500	8
5502022M5701A(R)	Australian (Type I)	AS3112 / 3 PRONG	IEC 320/C13	2500	8
204B4272M5701(R)	Brazil (Type N)	BRAZIL	IEC 320/C13	2500	8
6023602M5701(R)	China (Type I)	CCC GR2099	IEC 320/C13	2500	8
G8014272M5701(R)	Danish (Type K)	AFSNIT SECTION 107-2-D1	IEC 320/C13	2500	8
23144272M5701-T(R)	Europe (Type E)	CEE 7/7	IEC 320/C13	2500	8
23134272M5701EUKR(R)	Europe/Korea Combo (Type E)	CEE 7/7 / KSC8305	IEC 320/C13	2500	8
205IN4272M5701(R)	India (Type D)	India IS 1293 (also known as IA16A3 or BS546)	IEC 320/C13	2500	8
208IN4272M5701(R)	India (Type M)	India IS 1293 (also known as IA16A3 or BS546)	IEC320/C13	2500	8
377C4272M5701(R)	Israel (Type H)	ISL 377C	IEC 320/C13	2500	8
23024272M5701(R)	Italy (Type L)	CEI 23-16/VII	IEC 320/C13	2500	8
3003339F701(R) [3x1.25mm2]	Japan (Type B)	JIS 8303 / 3 PINS	IEC 320/C13	2500	8
3003068F2701-HK(R) [3 x 2.0mm2]					
302J115J6F0701J(R)	North America / Japan (Type B – 12A)	NEMA 5-15P (cULus approved), Japan JIS C 8303 (PSE Approved)	IEC 320/C13	1830	6
302J104J6F0701J(R)	North America / Japan (Type B – 15A)	NEMA 5-15P (cULus approved), Japan JIS C 8303 (PSE Approved)	IEC 320/C13	1830	6
302JT104J9F0701JT(R)	North America / Japan / Taiwan (Type B – 15A)	NEMA 5-15P (cULus approved), Japan JIS C 8303 (PSE Approved), Taiwan CNS 6797 (BSMI Approved)	IEC 320/C13	2800	9
2313K3432M5701(R)	Korea (Type F)	KS C 8305	IEC 320/C13	2500	8
5804272M5701(R)	Russia (Type F)	GOST 7396	IEC 320/C13	2500	8
2084272M5701(R)	South Africa (Type M)	South Africa SABS164-1 (16A type)	IEC 320/C13	2500	8

PROPRIETARY INFORMATION

PROPRIETARY OF GLOBTEK, INC. ANY REPRODUCTION, DISCLOSURE OR USE OF THIS DRAWING, IN WHOLE OR IN PART, IS HEREBY PROHIBITED EXCEPT AS SPECIFIED IN Page 10 of 18

WRITING BY GLOBTEK, INC. © GlobTek, Inc. 2018 - 2023

quest / 08/08/2023 6:17:57 AM GMT CLONED FROM RR9K11500CCPIMNAR6B

GlobTek, Inc. www.globtek.com 186 Veterans Drive, Northvale, NJ 07647 Tel. (201) 784-1000 Fax (201) 784-0111	Drawing Title: GTM96300-3624-T3, Medical/ICT/ITE/Household use Power Supply, Efficiency Level: USA DOE Level VI / Eco-design Directive 2009/125/EC, (EU) 2019/1782, Case Color/Style: GlobTek Black, Desktop/External, Regulated Switchmode AC-DC Power Supply AC Adaptor, Input Rating: 100-240V~, 50-60 Hz, IEC 60320/C14 , Output Rating: 36W, 24.0V@1.5A, Output Configuration: 1500 mm, 18/1C + Shield Cond, UL 1185, Female Barrel 5.5*2.1*11mm WITH internal Spring Clip and Locking Notch or Equal, Ferrite: None, GlobTek Black, GT Cord # C26632, Pin Out: Center Positive (+V), symbol compliant with IEC 60417 symbol no. 5926, Blades/Input Cord: Not Applicable, Approvals: CCC (up to 48V only); LPS 60950; CAN ICES-3; CB 62368; CB 60950; ETL 1310; ETL; ETL; 230V CoC Tier 2; EAC; UKCA; LPS 62368; GEMS (12V); UL 1310; Conforms to 62368-1; ETL 62368; Morocco; S-Mark 62368; Singapore (5V); NOM (5V only); Korea (5, 5.4, 5.95, 7.5V Only); India BIS (5,5.95,7.5,9,12,15,24,30,36 and 48V); Taiwan BSMI (5,5.4,5.95,7.5,9,12,15,18,19,24,30,36,48V only); IRAM (pending); South Africa; South Africa (pending); S-Mark 60950; RCM; CE; CE; CB 60335; S-Mark IEC/EN 60601-1; WEEE; VCCI; Ukraine;RoHS; Level VI; China RoHS; CE; PSE; PSE; PSE; CB 60601-1;	
	Model No. GTM96300-3624-T3	
	Part No./Ordering No. TR9CI1500CCPIMR6B	Rev C1

23214272M5701(R)	Switzerland (Type J)	SEV 1011	IEC 320/C13	2500	8
3003322M5701(R)	Taiwan (Type B)	BSMI	IEC 320/C13	2500	8
6363762M5701(R)	Thailand (Type O)	TIS 166-2549	IEC 320/C13	2500	8
PZ0800100-2M5BK13H	UK, Hong Kong, Singapore, Gulf States (Type G)	BS 1363A	IEC 320/C13	2500	8
7055002M5701A(R)	International	IEC 320 C14-C13	IEC 320/C13	2500	8

GlobTek, Inc. www.globtek.com 186 Veterans Drive, Northvale, NJ 07647 Tel. (201) 784-1000 Fax (201) 784-0111	Drawing Title: GTM96300-3624-T3, Medical/ICT/ITE/Household use Power Supply, Efficiency Level: USA DOE Level VI / Eco-design Directive 2009/125/EC, (EU) 2019/1782, Case Color/Style: GlobTek Black, Desktop/External, Regulated Switchmode AC-DC Power Supply AC Adaptor, Input Rating: 100-240V~, 50-60 Hz, IEC 60320/C14 , Output Rating: 36W, 24.0V@1.5A, Output Configuration: 1500 mm, 18/1C + Shield Cond, UL 1185, Female Barrel 5.5*2.1*11mm WITH internal Spring Clip and Locking Notch or Equal, Ferrite: None, GlobTek Black, GT Cord # C26632, Pin Out: Center Positive (+V), symbol compliant with IEC 60417 symbol no. 5926, Blades/Input Cord: Not Applicable, Approvals: CCC (up to 48V only); LPS 60950; CAN ICES-3; CB 62368; CB 60950; ETL 1310; ETL; ETL; 230V CoC Tier 2; EAC; UKCA; LPS 62368; GEMS (12V); UL 1310; Conforms to 62368-1; ETL 62368; Morocco; S-Mark 62368; Singapore (5V); NOM (5V only); Korea (5, 5.4, 5.95, 7.5V Only); India BIS (5,5.95,7.5,9,12,15,24,30,36 and 48V); Taiwan BSMI (5,5.4,5.95,7.5,9,12,15,18,19,24,30,36,48V only); IRAM (pending); South Africa; South Africa (pending); S-Mark 60950; RCM; CE; CE; CB 60335; S-Mark IEC/EN 60601-1; WEEE; VCCI; Ukraine;RoHS; Level VI; China RoHS; CE; PSE; PSE; PSE; CB 60601-1;	
	Model No. GTM96300-3624-T3	
	Part No./Ordering No. TR9CI1500CCPIMR6B	Rev C1

OUTPUT CORD AND CONNECTOR: C1S/C26632

ACTUAL CONNECTORS, OVERMOLDS, FERRITES MAY VARY SLIGHTLY FROM THE PICTURE BELOW

CABLE TYPE	UL 1185
CABLE LENGTH (mm)	1500
CABLE TOLERANCE (mm)	+150,-0
WIRE GAUGE (AWG)	18
CONDUCTORS	1C + Shield
HANK DIMENSION (mm)	80±10
CABLE / CONNECTOR OVERMOLD COLOR	GlobTek Black
FERRITE TYPE AND DIMENSION	None
FERRITE NUMBER OF TURNS (Definition)	N/A
FERRITE DIMENSION FROM STRAIN RELIEF	N/A
FERRITE DIMENSION FROM PLUG	N/A
PLUG TYPE	Female Barrel 5.5*2.1*11mm WITH internal Spring Clip and Locking Notch or Equal
OUTPUT CONNECTOR GENDER	Female
OVERMOLDED	Yes
OVER MOLD ORIENTATION	Straight
CONNECTOR PIN OUT	Center Positive (+V), symbol compliant with IEC 60417 symbol no. 5926

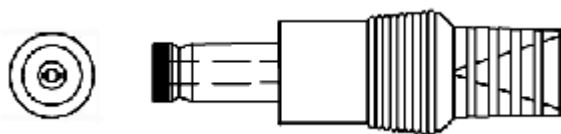

ADDITIONAL OUTPUT PLUG OPTIONS ARE AVAILABLE AT <https://www.globtek.com/connectors/>
STANDARD PLUGS AND CONNECTORS CAN BE SEEN ONLINE AT <https://www.globtek.com/connectors/>
CALCULATE VOLTAGE REGULATION/DROP WITH OUR ONLINE CALCULATOR: <https://en.globtek.com/output-cable-regulation-calculator/>

<p>GlobTek, Inc. www.globtek.com 186 Veterans Drive, Northvale, NJ 07647 Tel. (201) 784-1000 Fax (201) 784-0111</p>	<p>Drawing Title: GTM96300-3624-T3, Medical/ICT/ITE/Household use Power Supply, Efficiency Level: USA DOE Level VI / Eco-design Directive 2009/125/EC, (EU) 2019/1782, Case Color/Style: GlobTek Black, Desktop/External, Regulated Switchmode AC-DC Power Supply AC Adaptor, Input Rating: 100-240V~, 50-60 Hz, IEC 60320/C14 , Output Rating: 36W, 24.0V@1.5A, Output Configuration: 1500 mm, 18/1C + Shield Cond, UL 1185, Female Barrel 5.5*2.1*11mm WITH internal Spring Clip and Locking Notch or Equal, Ferrite: None, GlobTek Black, GT Cord # C26632, Pin Out: Center Positive (+V), symbol compliant with IEC 60417 symbol no. 5926, Blades/Input Cord: Not Applicable, Approvals: CCC (up to 48V only); LPS 60950; CAN ICES-3; CB 62368; CB 60950; ETL 1310; ETL; ETL; 230V CoC Tier 2; EAC; UKCA; LPS 62368; GEMS (12V); UL 1310; Conforms to 62368-1; ETL 62368; Morocco; S-Mark 62368; Singapore (5V); NOM (5V only); Korea (5, 5.4, 5.95, 7.5V Only); India BIS (5,5.95,7.5,9,12,15,24,30,36 and 48V); Taiwan BSMI (5,5.4,5.95,7.5,9,12,15,18,19,24,30,36,48V only); IRAM (pending); South Africa; South Africa (pending); S-Mark 60950; RCM; CE; CE; CB 60335; S-Mark IEC/EN 60601-1; WEEE; VCCI; Ukraine;RoHS; Level VI; China RoHS; CE; PSE; PSE; PSE; CB 60601-1;</p>	
	<p>Model No. GTM96300-3624-T3</p>	
	<p>Part No./Ordering No. TR9CI1500CCPIMR6B</p>	<p>Rev C1</p>

OUTPUT CONNECTOR HOOK UP

TO ADDRESS SYSTEM-LEVEL EMI CONCERNS, FERRITE CHOKES/BEADS MAY BE ADDED/REVISED UPON REQUEST. A SAMPLE KIT OF GLOBTEK'S STANDARD FERRITES IS AVAILABLE UNDER GLOBTEK P/N: EMI-MITIGATION-KIT1

FOR ADDITIONAL INFORMATION, PLEASE READ OUR WHITE PAPER AT:

<https://en.globtek.com/technical-articles/ferrite-kit-radiated-emi-suppression-kit-for-globtek-power-supplies-cable-assemblies>

GlobTek, Inc. www.globtek.com 186 Veterans Drive, Northvale, NJ 07647 Tel. (201) 784-1000 Fax (201) 784-0111	Drawing Title: GTM96300-3624-T3, Medical/ICT/ITE/Household use Power Supply, Efficiency Level: USA DOE Level VI / Eco-design Directive 2009/125/EC, (EU) 2019/1782, Case Color/Style: GlobTek Black, Desktop/External, Regulated Switchmode AC-DC Power Supply AC Adaptor, Input Rating: 100-240V~, 50-60 Hz, IEC 60320/C14, Output Rating: 36W, 24.0V@1.5A, Output Configuration: 1500 mm, 18/1C + Shield Cond, UL 1185, Female Barrel 5.5*2.1*11mm WITH internal Spring Clip and Locking Notch or Equal, Ferrite: None, GlobTek Black, GT Cord # C26632, Pin Out: Center Positive (+V), symbol compliant with IEC 60417 symbol no. 5926, Blades/Input Cord: Not Applicable, Approvals: CCC (up to 48V only); LPS 60950; CAN ICES-3; CB 62368; CB 60950; ETL 1310; ETL; ETL; 230V CoC Tier 2; EAC; UKCA; LPS 62368; GEMS (12V); UL 1310; Conforms to 62368-1; ETL 62368; Morocco; S-Mark 62368; Singapore (5V); NOM (5V only); Korea (5, 5.4, 5.95, 7.5V Only); India BIS (5.5.95, 7.5.9, 12, 15, 24, 30, 36 and 48V); Taiwan BSMI (5.5.4, 5.95, 7.5.9, 12, 15, 18, 19, 24, 30, 36, 48V only); IRAM (pending); South Africa; South Africa (pending); S-Mark 60950; RCM; CE; CE; CB 60335; S-Mark IEC/EN 60601-1; WEEE; VCCI; Ukraine; RoHS; Level VI; China RoHS; CE; PSE; PSE; PSE; CB 60601-1;
	Model No. GTM96300-3624-T3
	Part No./Ordering No. TR9CI1500CCPIMR6B

Rev C1

LABEL:L-1470

LABEL P/N	ISO 15223 medical device compliant label
MATERIAL	Flat Thermal Transfer, Imprintable, Polyester Label and/or Pad Printed and/or Molded, and/or Laser Engraved in the case
BACKGROUND COLOR	Black if housing is Black, White or Silver if housing is White or Gray.
TEXT COLOR	White or Silver if label is Black Background for Black housing. Black if label is White or Silver background and Housing is White or Gray.
LABEL WIDTH (mm)	35.0
LABEL HEIGHT (mm)	70.0
SPECIAL BARCODE LABEL MATERIAL	No

Below is the minimum information which will appear on the label. NOTE: in the logo area additional/actual positioning of symbols and text is subjected to change as per agency updates/requirements or additional model approvals become available.

Agency logos may be in Regulatory Certifications/Label Markings area on the label or molded into the case housing outside the label area. Information will be shown via Label and/or Pad Printed and/or Molded in the case.

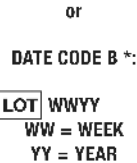
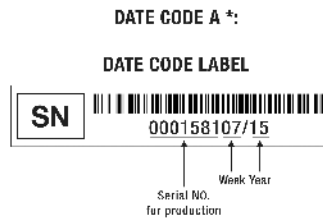

- A=Medical/ICT/ITE/Household use Power Supply
- B=P/N: (料号) TR9CI1500CCPIMR6B
- C=Model (型号) GTM96300-3624-T3
- D=Input (输入) 100-240V~, 50-60 Hz, 1.0A
- E=Output (输出) 24.0 V 1.5 A, 36.00W

GlobTek, Inc. www.globtek.com 186 Veterans Drive, Northvale, NJ 07647 Tel. (201) 784-1000 Fax (201) 784-0111	Drawing Title: GTM96300-3624-T3, Medical/ICT/ITE/Household use Power Supply, Efficiency Level: USA DOE Level VI / Eco-design Directive 2009/125/EC, (EU) 2019/1782, Case Color/Style: GlobTek Black, Desktop/External, Regulated Switchmode AC-DC Power Supply AC Adaptor, Input Rating: 100-240V~, 50-60 Hz, IEC 60320/C14 , Output Rating: 36W, 24.0V@1.5A, Output Configuration: 1500 mm, 18/1C + Shield Cond, UL 1185, Female Barrel 5.5*2.1*11mm WITH internal Spring Clip and Locking Notch or Equal, Ferrite: None, GlobTek Black, GT Cord # C26632, Pin Out: Center Positive (+V), symbol compliant with IEC 60417 symbol no. 5926, Blades/Input Cord: Not Applicable, Approvals: CCC (up to 48V only); LPS 60950; CAN ICES-3; CB 62368; CB 60950; ETL 1310; ETL; ETL; 230V CoC Tier 2; EAC; UKCA; LPS 62368; GEMS (12V); UL 1310; Conforms to 62368-1; ETL 62368; Morocco; S-Mark 62368; Singapore (5V); NOM (5V only); Korea (5, 5.4, 5.95, 7.5V Only); India BIS (5.5.95,7.5.9,12,15,24,30,36 and 48V); Taiwan BSMI (5.5.4,5.95,7.5.9,12,15,18,19,24,30,36,48V only); IRAM (pending); South Africa; South Africa (pending); S-Mark 60950; RCM; CE; CE; CB 60335; S-Mark IEC/EN 60601-1; WEEE; VCCI; Ukraine;RoHS; Level VI; China RoHS; CE; PSE; PSE; PSE; CB 60601-1;	
	Model No. GTM96300-3624-T3	
	Part No./Ordering No. TR9CI1500CCPIMR6B	Rev C1

AGENCY ONLINE DOCUMENTS	http://www.globtek.info/certs/GTM96300-TZ/
CE EC-Declaration for Medical	http://globtek.force.com/models/ec_declaration_product?id=01t0c000008OkOw&m=1
CE EC-Declaration for Industrial/Commercial/ITE	http://globtek.force.com/models/ec_declaration_product?id=01t0c000008OkOw&i=2
CE EC-Declaration for Household	http://globtek.force.com/models/ec_declaration_product?id=01t0c000008OkOw&h=2
UKCA-Declaration for Medical	http://globtek.force.com/models/ukca_declaration_product?id=01t0c000008OkOw&m=1
UKCA-Declaration for Industrial/Commercial/ITE	http://globtek.force.com/models/ukca_declaration_product?id=01t0c000008OkOw&i=2
UKCA-Declaration for Household	http://globtek.force.com/models/ukca_declaration_product?id=01t0c000008OkOw&h=2
Morocco SDoC Declaration	https://globtek.secure.force.com/models/Morocco_SDoC_Declaration?id=a0Oa000000MmJbIEAF
RoHS/RoHS3 Declaration	https://www.globtek.com/pdf/rohs_cert/01t0c000008OkOwAAK
REACH Declaration	https://www.globtek.com/pdf/iso_certificates/REACH.pdf
Conflict Minerals Declaration	https://www.globtek.com/pdf/conflict-minerals.pdf
Prop 65 Statement	https://en.globtek.com/prop-65-statement.pdf
IPXY rating is based on 3rd party testing and customers should check suitability and test system level IPXY rating before ordering.	

Regulatory Certifications/Label Markings

Below follows a link to the latest regulatory certifications and marks for this specific product. National standards as well as certification schemes are constantly changing and so is the set of certification marks and symbols applicable to this product. Various standards, marks and symbols, and certificates are subject to change at any time without notice.

Additional standards or unique country certifications are available upon request. Please contact Globtek to request a quotation.

LATEST PRODUCT/MODEL CERTIFICATIONS:	https://www.globtek.com/datasheet/w71088
AGENCY ONLINE DOCUMENTS	http://www.globtek.info/certs/GTM96300-TZ/
	(F2) Isolated Functional Earth for GTM96 series, Improved EMC

	Center Positive (+V), symbol compliant with IEC 60417 symbol no. 5926
--	---

GlobTek, Inc. www.globtek.com 186 Veterans Drive, Northvale, NJ 07647 Tel. (201) 784-1000 Fax (201) 784-0111	Drawing Title: GTM96300-3624-T3, Medical/ICT/ITE/Household use Power Supply, Efficiency Level: USA DOE Level VI / Eco-design Directive 2009/125/EC, (EU) 2019/1782, Case Color/Style: GlobTek Black, Desktop/External, Regulated Switchmode AC-DC Power Supply AC Adaptor, Input Rating: 100-240V~, 50-60 Hz, IEC 60320/C14 , Output Rating: 36W, 24.0V@1.5A, Output Configuration: 1500 mm, 18/1C + Shield Cond, UL 1185, Female Barrel 5.5*2.1*11mm WITH internal Spring Clip and Locking Notch or Equal, Ferrite: None, GlobTek Black, GT Cord # C26632, Pin Out: Center Positive (+V), symbol compliant with IEC 60417 symbol no. 5926, Blades/Input Cord: Not Applicable, Approvals: CCC (up to 48V only); LPS 60950; CAN ICES-3; CB 62368; CB 60950; ETL 1310; ETL; ETL; 230V CoC Tier 2; EAC; UKCA; LPS 62368; GEMS (12V); UL 1310; Conforms to 62368-1; ETL 62368; Morocco; S-Mark 62368; Singapore (5V); NOM (5V only); Korea (5, 5.4, 5.95, 7.5V Only); India BIS (5,5.95,7.5,9,12,15,24,30,36 and 48V); Taiwan BSMI (5,5.4,5.95,7.5,9,12,15,18,19,24,30,36,48V only); IRAM (pending); South Africa; South Africa (pending); S-Mark 60950; RCM; CE; CE; CB 60335; S-Mark IEC/EN 60601-1; WEEE; VCCI; Ukraine;RoHS; Level VI; China RoHS; CE; PSE; PSE; PSE; CB 60601-1;	
	Model No. GTM96300-3624-T3	
	Part No./Ordering No. TR9CI1500CCPIMR6B	Rev C1

PACKAGING

Packing Spec P/N	Standard DT, Individually Box, GT User Manual
Box Qty	60
Gift Box Size (mm)	142*62*60
Gift Box Color	White
Master Carton Size (mm)	442 x 330 x 275
Master Carton Cubic Volume (m³)	0.04
Master GW (Kg)	15.2 kg
BLADES INCLUDED	N/A: Not Applicable
BLADE/CORD INSTALLED	N/A: Not Applicable
USER MANUAL*	809-DESKTOPUSERMANUAL on A4 paper
USER MANUAL WEB LINK	https://en.globtek.com/pdf/809-DESKTOPUSERMANUAL.jpg

* This specification sheet is considered the user manual for all applications. It is expected that the buyer of this product will use it to formulate their own user manual for their end product and a user manual specifically for the power adapter is not usually required. If a user manual is not specifically listed above then none will be provided with this unit.

If specific packaging is required, this section must specify all requirements and note "no exceptions". If this section does not specify packaging, it is subject to change without notice at GlobTek's discretion

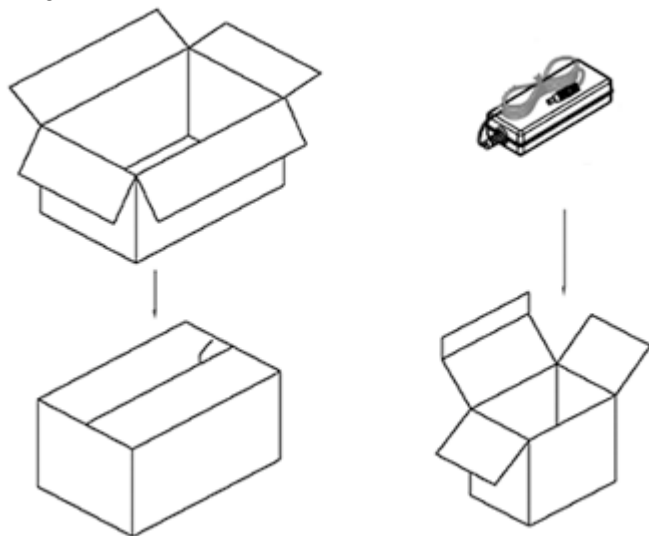

PROPRIETARY INFORMATION

PROPRIETARY OF GLOBTEK, INC. ANY REPRODUCTION, DISCLOSURE OR USE OF THIS DRAWING, IN WHOLE OR IN PART, IS HEREBY PROHIBITED EXCEPT AS SPECIFIED IN Page 16 of 18
WRITING BY GLOBTEK, INC. © GlobTek, Inc. 2018 - 2023
quest / 08/08/2023 6:17:57 AM GMT CLONED FROM RR9KI1500CCPIMNAR6B

<p>GlobTek, Inc. www.globtek.com 186 Veterans Drive, Northvale, NJ 07647 Tel. (201) 784-1000 Fax (201) 784-0111</p>	<p>Drawing Title: GTM96300-3624-T3, Medical/ICT/ITE/Household use Power Supply, Efficiency Level: USA DOE Level VI / Eco-design Directive 2009/125/EC, (EU) 2019/1782, Case Color/Style: GlobTek Black, Desktop/External, Regulated Switchmode AC-DC Power Supply AC Adaptor, Input Rating: 100-240V~, 50-60 Hz, IEC 60320/C14 , Output Rating: 36W, 24.0V@1.5A, Output Configuration: 1500 mm, 18/1C + Shield Cond, UL 1185, Female Barrel 5.5*2.1*11mm WITH internal Spring Clip and Locking Notch or Equal, Ferrite: None, GlobTek Black, GT Cord # C26632, Pin Out: Center Positive (+V), symbol compliant with IEC 60417 symbol no. 5926, Blades/Input Cord: Not Applicable, Approvals: CCC (up to 48V only); LPS 60950; CAN ICES-3; CB 62368; CB 60950; ETL 1310; ETL; ETL; 230V CoC Tier 2; EAC; UKCA; LPS 62368; GEMS (12V); UL 1310; Conforms to 62368-1; ETL 62368; Morocco; S-Mark 62368; Singapore (5V); NOM (5V only); Korea (5, 5.4, 5.95, 7.5V Only); India BIS (5,5.95,7.5,9,12,15,24,30,36 and 48V); Taiwan BSMI (5,5.4,5.95,7.5,9,12,15,18,19,24,30,36,48V only); IRAM (pending); South Africa; South Africa (pending); S-Mark 60950; RCM; CE; CE; CB 60335; S-Mark IEC/EN 60601-1; WEEE; VCCI; Ukraine;RoHS; Level VI; China RoHS; CE; PSE; PSE; PSE; CB 60601-1;</p>	
	<p>Model No. GTM96300-3624-T3</p>	
	<p>Part No./Ordering No. TR9CI1500CCPIMR6B</p>	<p>Rev C1</p>

INSTRUCTIONS TO THE OEM SYSTEMS ENGINEER

It is the responsibility of the OEM systems engineer to provide the end system user instructions and warnings for the use of this product in the end system.

If an input cord is required for this product, AC Mains voltage should be provided to the power supply by a power supply cord approved to the national standards of the country in which it will be used.

This product is not designed to be repaired. No serviceable parts inside. A blown internal fuse is an indication of catastrophic failure of circuit component(s). If a Failure Analysis is required for a failed power supply/battery charger, please return the damaged unit to GlobTek for an accurate determination of the root cause of the failure.

EMC Compliance of the complete OEM product, including the GlobTek power supply/battery charger needs to be verified by the OEM systems engineer.

INSTRUCTION SHEET

N/A

<p>GlobTek, Inc. www.globtek.com 186 Veterans Drive, Northvale, NJ 07647 Tel. (201) 784-1000 Fax (201) 784-0111</p>	<p>Drawing Title: GTM96300-3624-T3, Medical/ICT/ITE/Household use Power Supply, Efficiency Level: USA DOE Level VI / Eco-design Directive 2009/125/EC, (EU) 2019/1782, Case Color/Style: GlobTek Black, Desktop/External, Regulated Switchmode AC-DC Power Supply AC Adaptor, Input Rating: 100-240V~, 50-60 Hz, IEC 60320/C14 , Output Rating: 36W, 24.0V@1.5A, Output Configuration: 1500 mm, 18/1C + Shield Cond, UL 1185, Female Barrel 5.5*2.1*11mm WITH internal Spring Clip and Locking Notch or Equal, Ferrite: None, GlobTek Black, GT Cord # C26632, Pin Out: Center Positive (+V), symbol compliant with IEC 60417 symbol no. 5926, Blades/Input Cord: Not Applicable, Approvals: CCC (up to 48V only); LPS 60950; CAN ICES-3; CB 62368; CB 60950; ETL 1310; ETL; ETL; 230V CoC Tier 2; EAC; UKCA; LPS 62368; GEMS (12V); UL 1310; Conforms to 62368-1; ETL 62368; Morocco; S-Mark 62368; Singapore (5V); NOM (5V only); Korea (5, 5.4, 5.95, 7.5V Only); India BIS (5,5.95,7.5,9,12,15,24,30,36 and 48V); Taiwan BSMI (5,5.4,5.95,7.5,9,12,15,18,19,24,30,36,48V only); IRAM (pending); South Africa; South Africa (pending); S-Mark 60950; RCM; CE; CE; CB 60335; S-Mark IEC/EN 60601-1; WEEE; VCCI; Ukraine;RoHS; Level VI; China RoHS; CE; PSE; PSE; PSE; CB 60601-1;</p>	
	<p>Model No. GTM96300-3624-T3</p>	
	<p>Part No./Ordering No. TR9CI1500CCPIMR6B</p>	<p>Rev C1</p>

