

1871843-4 ✓ ACTIVE



GRACE INERTIA 2.5

TE Internal #: 1871843-4

PCB Mount Header, Vertical, Wire-to-Board, 4 Position, 2.5 mm [.098 in] Centerline, Fully Shrouded, Tin, Through Hole - Solder, GRACE INERTIA 2.5

[View on TE.com >](#)

Connectors > PCB Connectors > PCB Headers & Receptacles



Connector System: **Wire-to-Board**

Number of Positions: **4**

Number of Rows: **1**

Centerline (Pitch): **2.5 mm [.098 in]**

PCB Mount Orientation: **Vertical**

Features

Product Type Features

Connector System	Wire-to-Board
Header Type	Fully Shrouded
Sealable	No
Connector & Contact Terminates To	Printed Circuit Board
PCB Connector Assembly Type	PCB Mount Header

Configuration Features

Number of Positions	4
Number of Rows	1
PCB Mount Orientation	Vertical

Electrical Characteristics

Operating Voltage	50 VAC
-------------------	--------

Body Features

Primary Product Color	Natural
-----------------------	---------



Contact Features

PCB Contact Termination Area Plating Material Thickness	1 µm[39.37 µin]
Contact Layout	Inline
Mating Tab Width	.7 mm[.028 in]
Mating Tab Thickness	.5 mm[.02 in]
Contact Underplating Material Thickness	1.27 µm[50 µin]
Contact Mating Area Plating Material Thickness	1 µm[39.37 µin]
PCB Contact Termination Area Plating Material Finish	Matte
Contact Mating Area Plating Material Finish	Matte
Contact Underplating Material	Nickel
PCB Contact Termination Area Plating Material	Tin
Contact Base Material	Brass
Contact Mating Area Plating Material	Tin
Contact Type	Tab
Contact Current Rating (Max)	3.5 A

Termination Features

Square Termination Post & Tail Dimension	.5 mm[.02 in]
Termination Post & Tail Length	3 mm[.118 in]
Termination Method to Printed Circuit Board	Through Hole - Solder

Mechanical Attachment

PCB Mount Alignment Type	Boss
Mating Alignment Type	Polarization
Mating Retention	With
PCB Mount Retention Type	Kinked
Connector Mounting Type	Board Mount
Mating Alignment	With
PCB Mount Alignment	With
PCB Mount Retention	With

Housing Features

Housing Material	6/6 Nylon GF
Centerline (Pitch)	2.5 mm[.098 in]

Dimensions

--	--



Connector Length	12.5 mm[.492 in]
Connector Height	11.3 mm[.44 in]
Connector Width	7 mm[.27 in]
PCB Thickness (Recommended)	1.6 mm[.063 in]

Usage Conditions

Operating Temperature Range	-30 – 105 °C[-22 – 221 °F]
-----------------------------	----------------------------

Operation/Application

Circuit Application	Signal
---------------------	--------

Industry Standards

Agency/Standard	UL
UL Flammability Rating	UL 94V-0

Packaging Features

Packaging Quantity	300
Packaging Type	Bag

Product Compliance

[For compliance documentation, visit the product page on TE.com>](#)

EU RoHS Directive 2011/65/EU	Compliant
EU ELV Directive 2000/53/EC	Compliant
China RoHS 2 Directive MIIT Order No 32, 2016	No Restricted Materials Above Threshold
EU REACH Regulation (EC) No. 1907/2006	Current ECHA Candidate List: JUNE 2023 (235) Candidate List Declared Against: JUNE 2023 (235) Does not contain REACH SVHC
Halogen Content	Not Low Halogen - contains Br or Cl > 900 ppm.
Solder Process Capability	Wave solder capable to 265°C

Product Compliance Disclaimer

This information is provided based on reasonable inquiry of our suppliers and represents our current actual knowledge based on the information they provided. This information is subject to change. The part numbers that TE has identified as EU RoHS compliant have a maximum concentration of 0.1% by weight in homogenous materials for lead, hexavalent chromium, mercury, PBB, PBDE, DBP, BBP, DEHP, DIBP, and 0.01% for cadmium, or qualify for an exemption to these limits as defined in the Annexes of Directive 2011/65/EU (RoHS2). Finished electrical and electronic equipment products will be CE marked as required by Directive 2011/65/EU. Components may not be CE marked. Additionally, the part numbers that TE has identified as EU ELV compliant have a maximum concentration of 0.1% by weight in homogenous materials for lead, hexavalent chromium, and mercury, and 0.01% for cadmium, or qualify for an exemption to these limits as defined in the Annexes of Directive 2000/53/EC (ELV). Regarding the REACH Regulation, the information TE provides

on SVHC in articles for this part number is based on the latest European Chemicals Agency (ECHA) 'Guidance on requirements for substances in articles' posted at this URL: <https://echa.europa.eu/guidance-documents/guidance-on-reach>

Compatible Parts



TE Part # 1-1871843-3
GIC 2.5 HDR ASSY TIN VERSION 3P RED

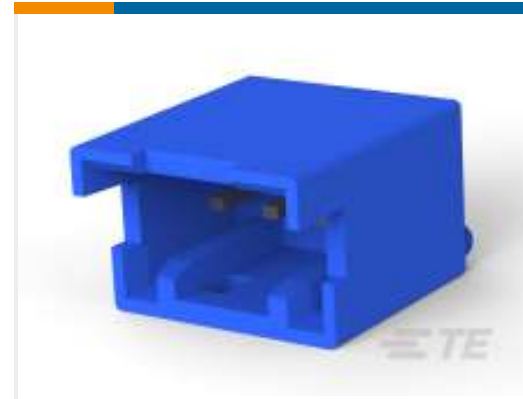

TE Part # 2-1871843-3
GIC 2.5 HDR ASSY TIN VERSION 3P BLUE

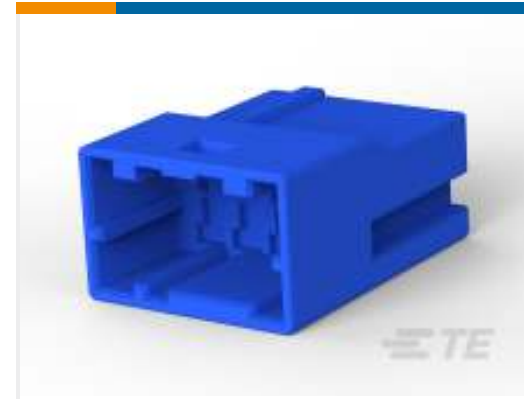

TE Part # 2-1903393-3
GIC 2.5 W CAP HSG 4P BLUE



TE Part # 1-1871843-2
GIC2.5 HDR ASSY TIN VERSION 2P RED



TE Part # 2134303-1
GIC 2.5 HDR ASSY TIN VERSION 2/4P



TE Part # 1-1903393-2
GIC 2.5 W CAP HSG 4P RED



TE Part # 1903393-1
GIC 2.5 W CAP HSG 4P NATURAL



TE Part # 1903535-1
GIC 2.5 PITCH CONN. HDR Assy (5 POS)



TE Part # 3-1903393-4
GIC 2.5 W CAP HSG 4P YELLOW



TE Part # 1-1871843-5
GIC 2.5 HDR ASSY TIN VERSION 5P RED



TE Part # 1-1871843-6
GIC2.5 HDR ASSY TIN VERSION 6P RED



TE Part # 1-1871843-8
GIC 2.5 HDR ASSY TIN VERSION 8P RED



TE Part # 1871843-8
GIC2.5 HDR ASSY TIN VERSION 8P NATURAL



TE Part # 2-1871843-5
GIC 2.5 HDR ASSY TIN VERSION 5P BLUE



TE Part # 2013485-1
GIC 2.5 HDR ASSY TIN VERSION 3/5P



TE Part # 2013523-1
GIC 2.5 HDR ASSY TIN VERSION 2/3P



Also in the Series | GRACE INERTIA 2.5

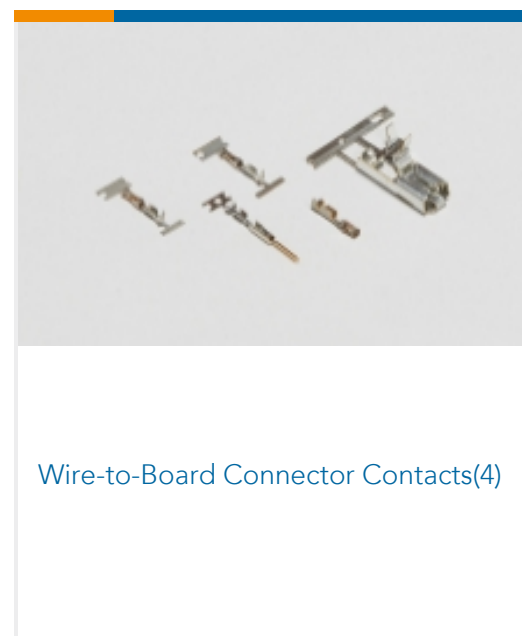
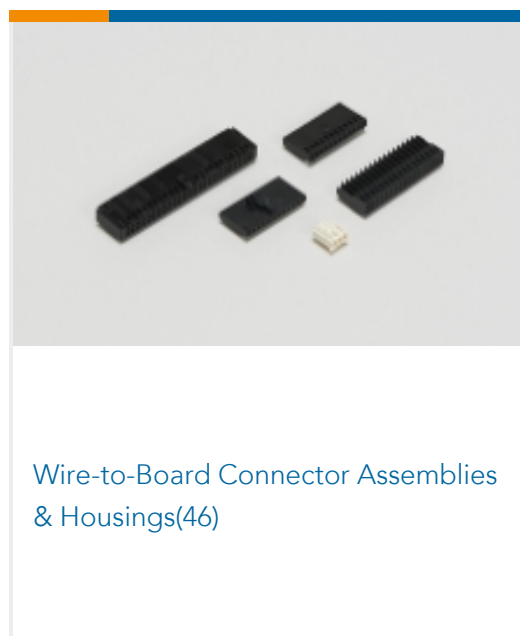
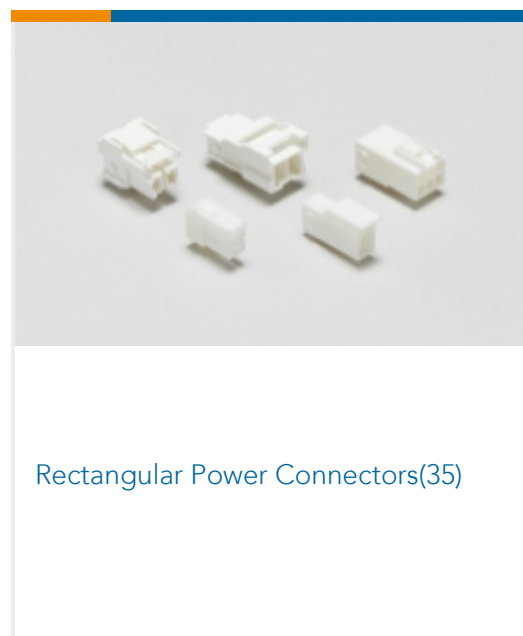
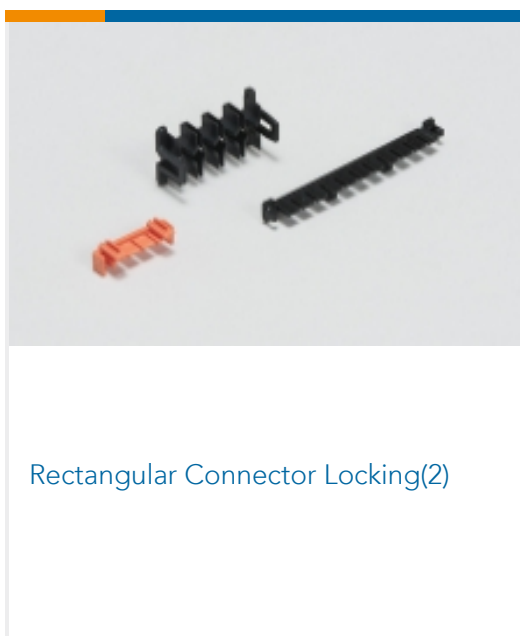
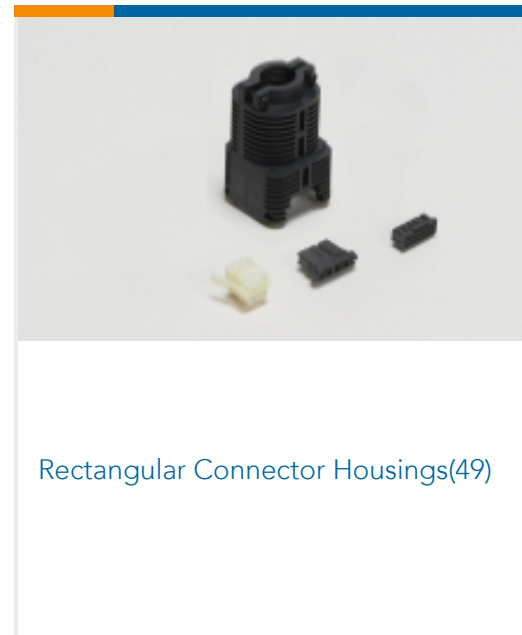
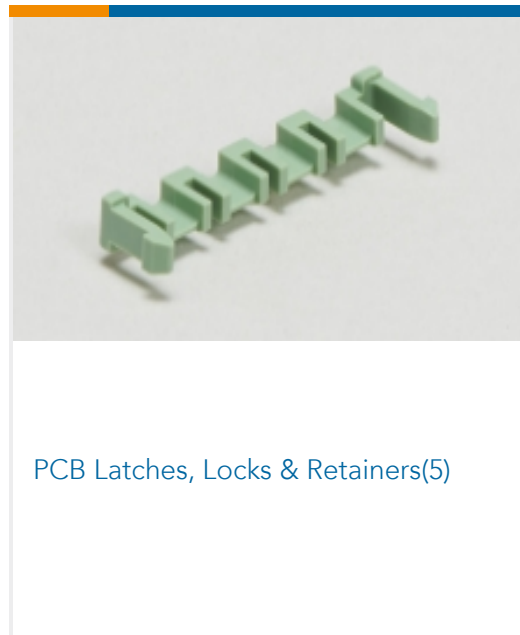
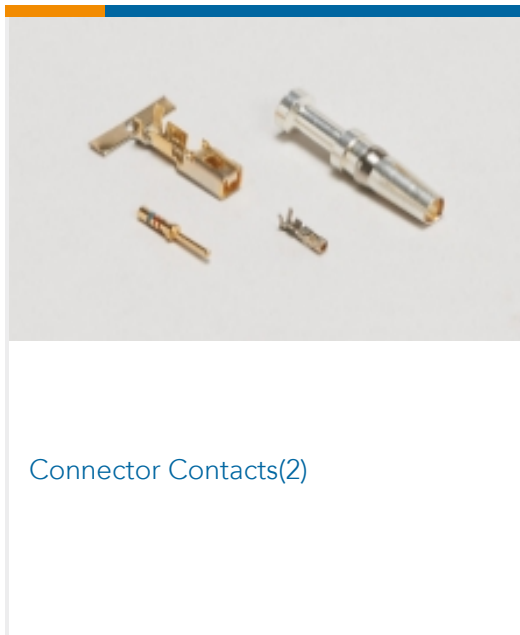

Customers Also Bought

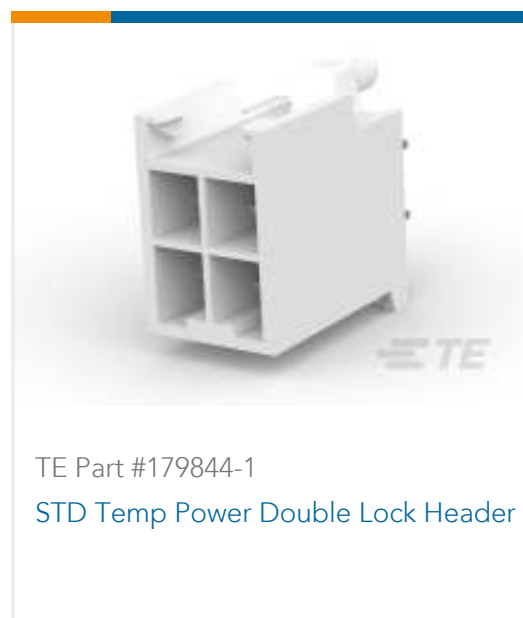

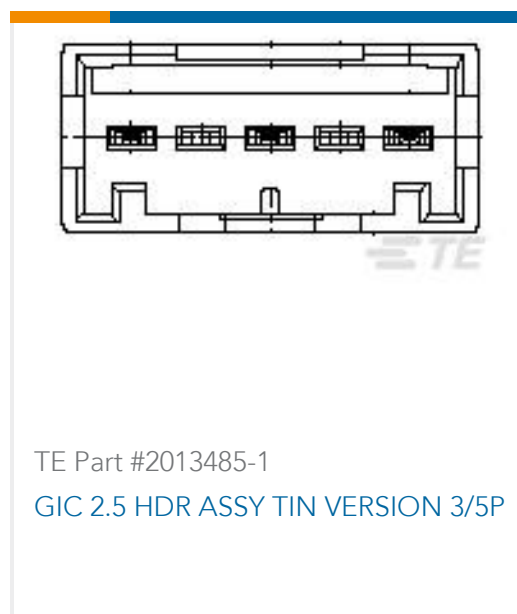

Documents

Product Drawings

[GIC2.5 HDR ASSY TIN VERSION 4P NATURAL](#)

English

CAD Files

[3D PDF](#)

3D

Customer View Model

[ENG_CVM_CVM_1871843-4_D.2d_dxf.zip](#)

English

Customer View Model

[ENG_CVM_CVM_1871843-4_D.3d_igs.zip](#)

English

Customer View Model

[ENG_CVM_CVM_1871843-4_D.3d_stp.zip](#)

English

By downloading the CAD file I accept and agree to the [Terms and Conditions](#) of use.

Product Specifications

[Application Specification](#)

English

Product Environmental Compliance

[MD_1871843-4_082020181142_dmtec](#)

English

[MD_1871843-4_082020181142_dmtec](#)

English