

QT-Brightek SMD Display Series

0.39" Single Digit Display

Part No.: QBSS39ZCX

C= Special Color

X= Color

Z= 1: Common Cathode

Z = 0: Common Anode

Product: QBSS39ZCX	Date: April 03, 2018	Page 1 of 13
	Version# 1.0	

Table of Contents:

Introduction	3
Electrical / Optical Characteristic: (Ta=25 °C)	4
Absolute Maximum Rating	4
Pin Configuration	5
Correlated Color Temperature Chart	6
Characteristic Curves.....	7
Solder Profile & Footprint.....	9
Packing & Labeling	11
Ordering Information	12
Revision History	13
Disclaimer	13

Electrical / Optical Characteristic: (Ta=25 °C)

Product		Material	Color	V _F (V)@ I _F =10mA		Chromaticity Coordinates @ I _F =10mA			I _V (mcd) @ I _F =5mA
CC	CA			Typ.	Max.	Min.	Typ.	Max.	Typ.
QBSS391CR	QBSS390CR	InGaN	Pink	3.2	3.8	--	X=0.39 Y=0.25	--	30
QBSS391CG	QBSS390CG	InGaN	Apple Green	3.2	3.8	--	X=0.23 Y=0.31	--	50
QBSS391CB	QBSS390CB	InGaN	Sky Blue	3.2	3.8	--	X=0.17 Y=0.14	--	40

Absolute Maximum Rating

Material	P _d (mW)	Derating linear from 25°C per dice (mA/°C)	I _F (mA)	I _{PF} (mA)*	V _R (V)	T _{OP} (°C)	T _{ST} (°C)	T _{SOL} (°C)**
InGaN	120	0.4	30	100	5	-40 to +105	-40 to +105	260

*Duty 1/10 @ 1KHz

**IR Reflow for no more than 5 sec @ 260 °C

Luminous Intensity I_V For CR @ I_F=5mA

Bin	Min.	Max.	Unit
L	17	27.5	mcd
M	27.5	44	
N	44	70.5	

Luminous Intensity I_V For CG @ I_F=5mA

Bin	Min.	Max.	Unit
M	27.5	44	mcd
N	44	70.5	
P	70.5	112.9	

Luminous Intensity I_V For CB @ I_F=5mA

Bin	Min.	Max.	Unit
M	27.5	44	mcd
N	44	70.5	
P	70.5	112.9	

Note:

Tolerance of measurement of luminous intensity: ±15%

Pin Configuration

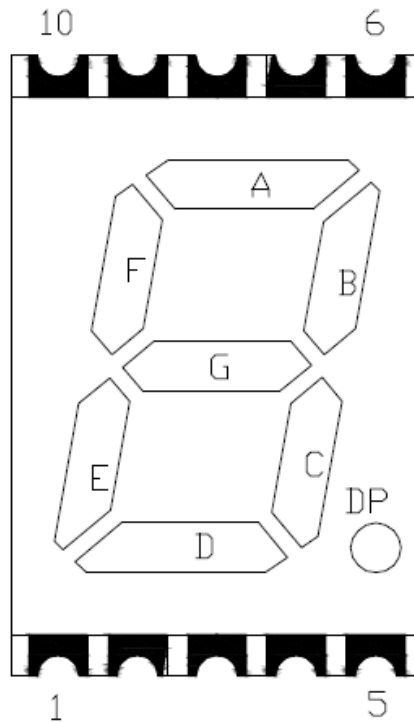

CC

CA

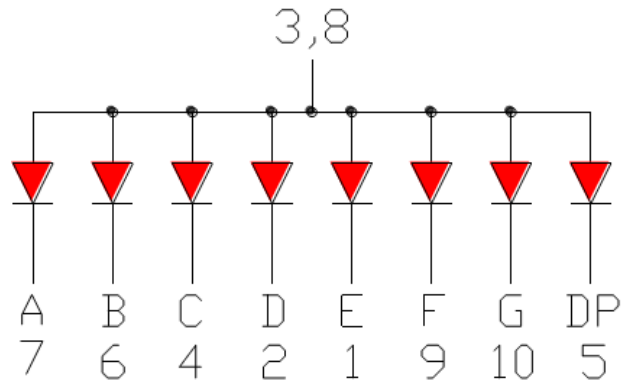
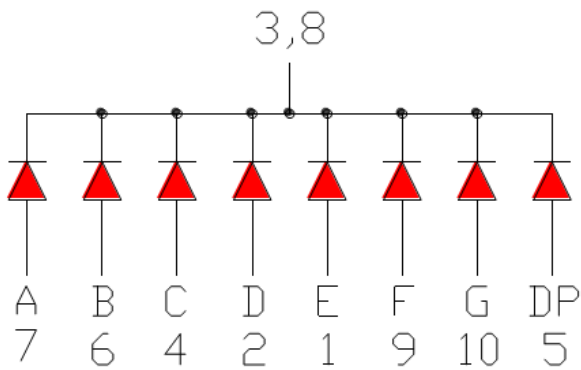

Correlated Color Temperature Chart

@ $I_F=10mA$

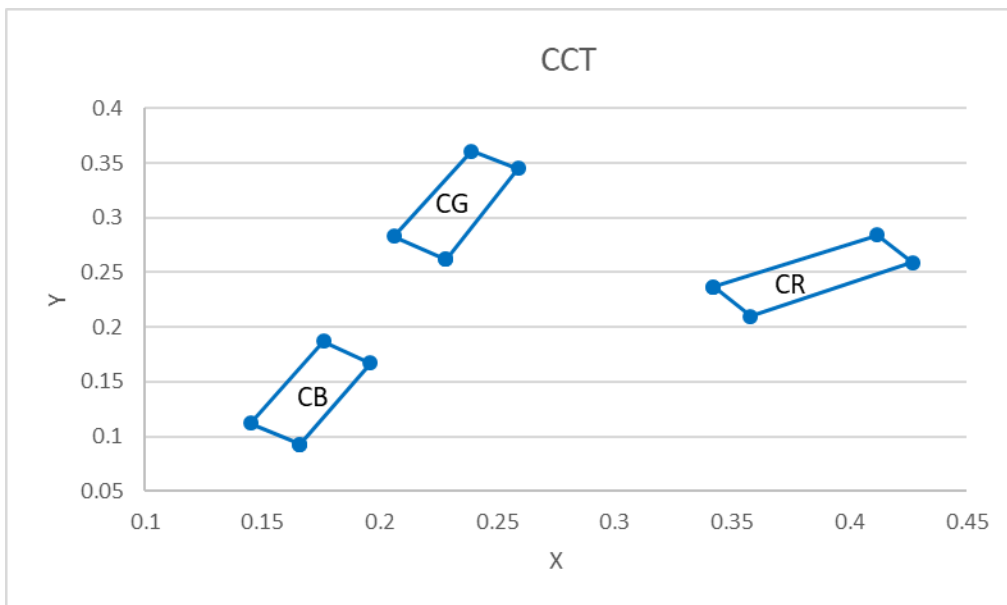

Sky Blue (CB)		Apple Green (CG)		Pink (CR)	
0.166	0.093	0.228	0.262	0.342	0.237
0.145	0.112	0.206	0.283	0.358	0.21
0.176	0.187	0.239	0.361	0.427	0.259
0.196	0.167	0.259	0.345	0.412	0.284
0.166	0.093	0.228	0.262	0.342	0.237

Characteristic Curves

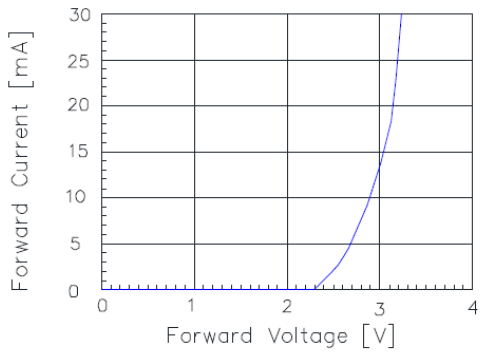

Fig 1. Forward Current vs. Forward Voltage

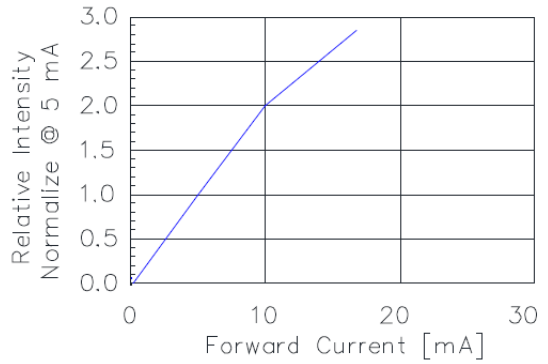

Fig 2. Relative Intensity vs. Forward Current

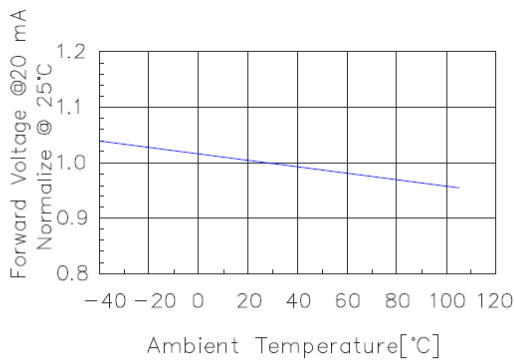

Fig 3. Forward Voltage vs. Temperature

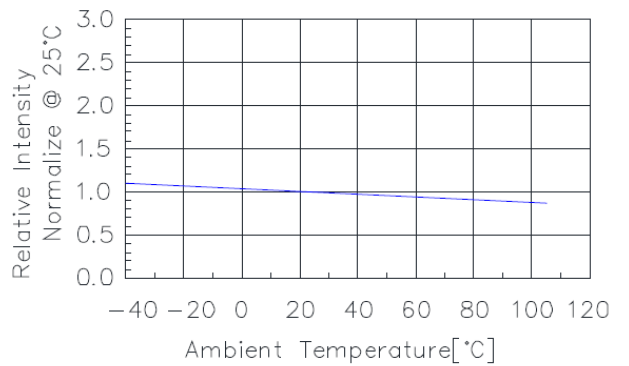

Fig 4. Relative Intensity vs. Temperature

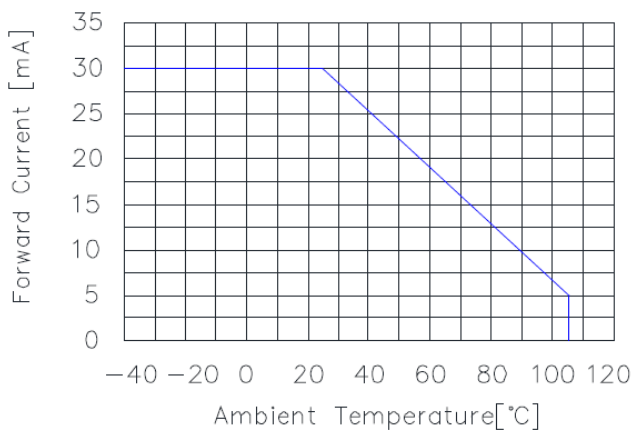

Fig 5. Forward current vs. Temperature

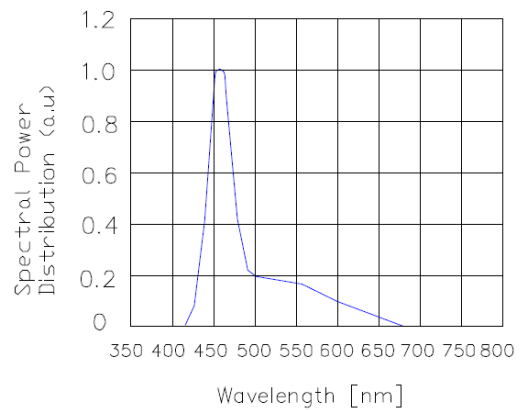

Fig 6.CB Spectral Power Distribution vs. Wavelength

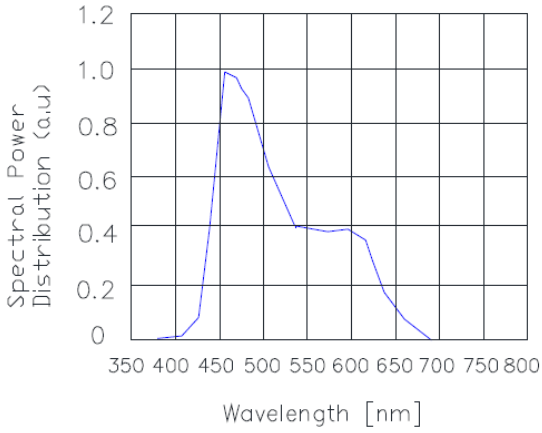

Fig 7.CG Spectral Power Distribution vs. Wavelength

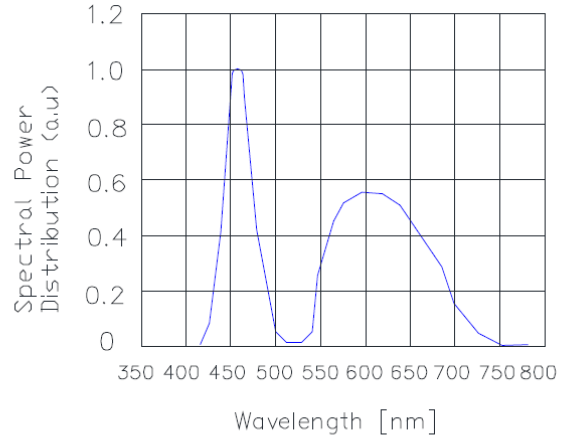
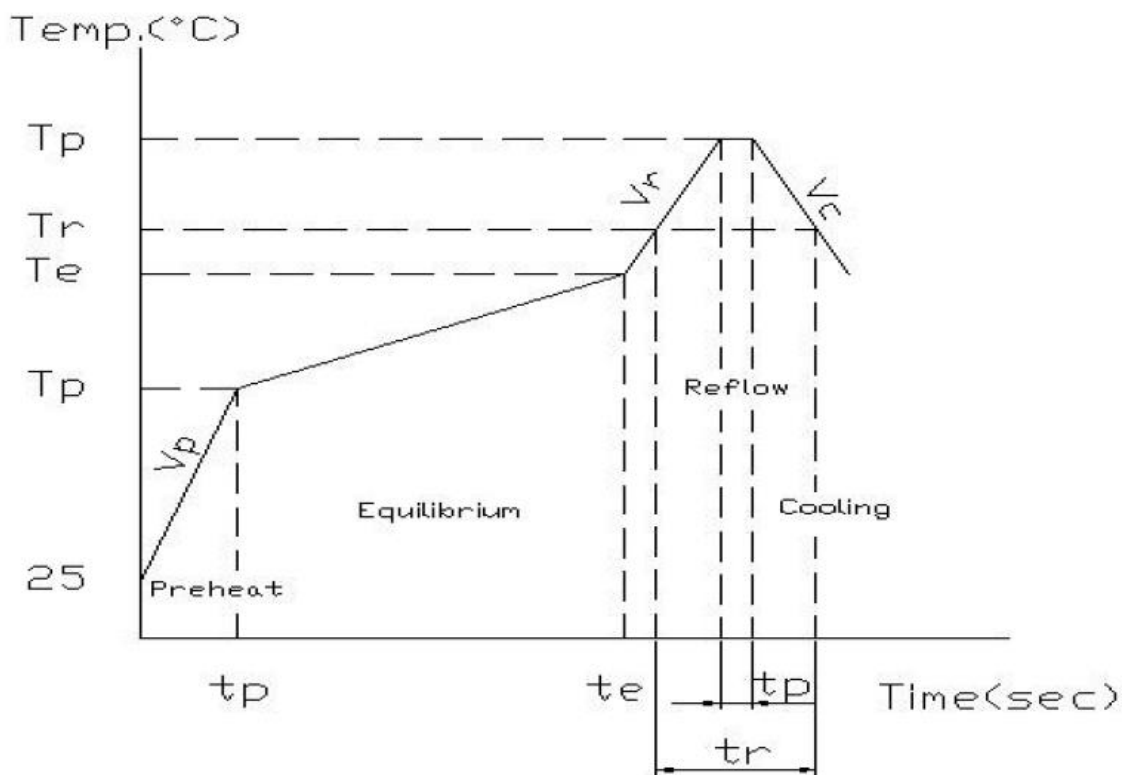

Fig 8.CR Spectral Power Distribution vs. Wavelength

Solder Profile & Footprint

1.IR-Reflow Soldering Profile(Pb Free)

Area	Title	Symbol	Min	Max	Unit
(1)Preheat	Ramp-up rate	Vp	1	5	°C/sec
	temperature	Tp	150	—	°C
	time	tp	—	—	sec
(2)Equilibrium	Ramp-up rate	Ve	—	—	°C/sec
	temperature	Te	150	200	°C
	Time	te	60	120	sec
(3)Reflow	Ramp-up rate	Vr	1	5	°C/sec
	temperature	Tr	220	—	°C
	Time	tr	—	60	sec
	Peak temperature	Trp	—	260	°C
	Peak time	trp	—	10	sec
(4)Cooling	Ramp-down rate	Vc	3	6	°C/sec



Recommended Pad Layout

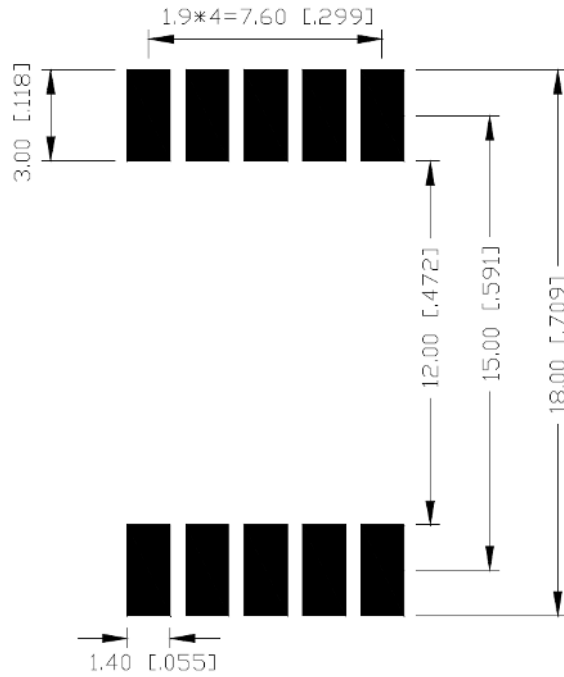

Units: mm

Tolerance: ±0.25mm

Packing & Labeling

Reel Dimensions:

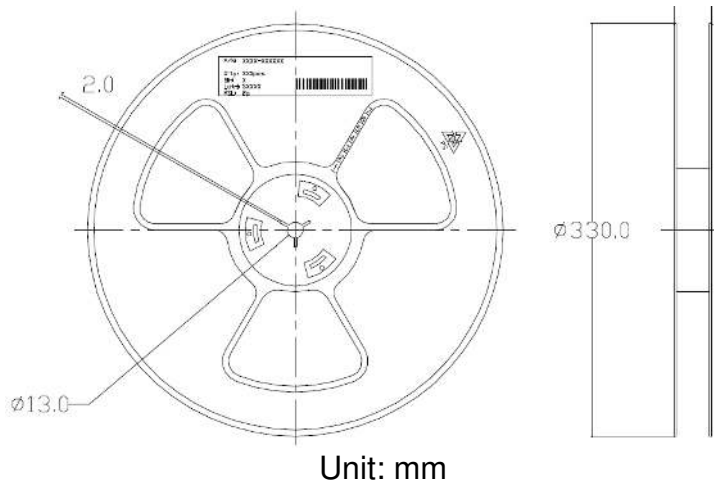

Packing Method:

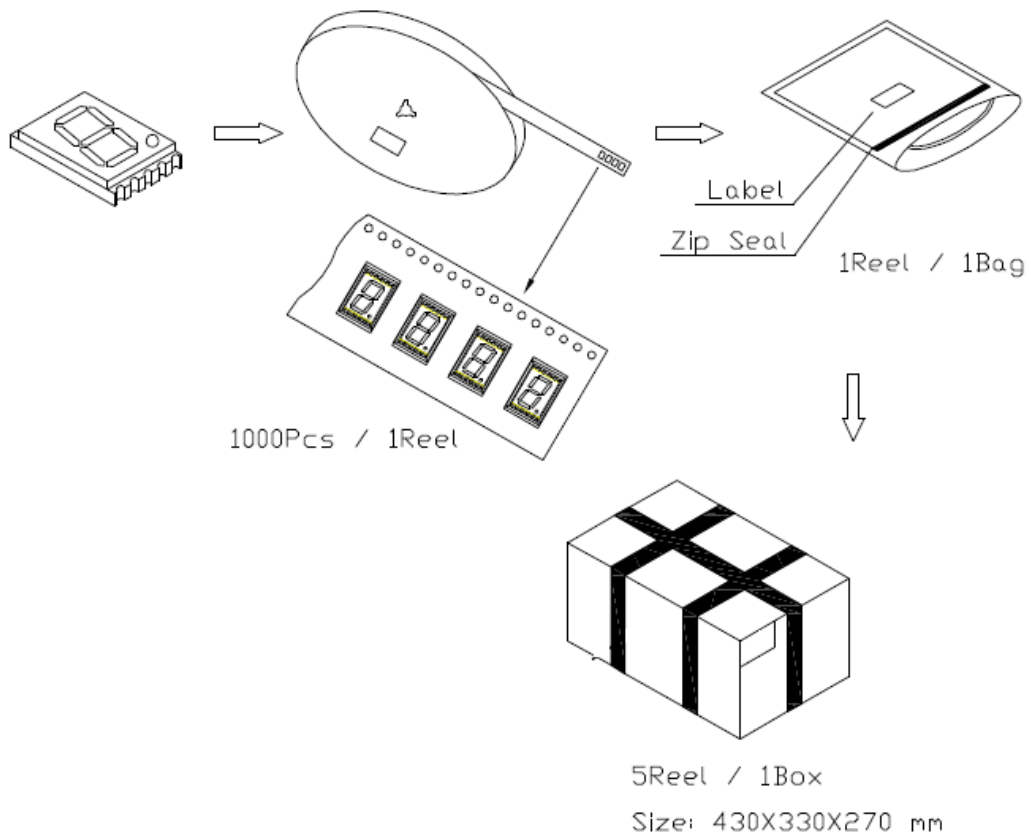

Ordering Information

Product		Orderable Part #		Spec Range	Quantity per Reel
CC	CA	CC	CA		
QBSS391CR	QBSS390CR	QBSS391CR	QBSS390CR	$I_v=30\text{mcd typ. @ } I_F=5\text{mA} / (X,Y)=(0.39,0.25)$	1000
QBSS391CG	QBSS390CG	QBSS391CG	QBSS390CG	$I_v=50\text{mcd typ. @ } I_F=5\text{mA} / (X,Y)=(0.23,0.31)$	1000
QBSS391CB	QBSS390CB	QBSS391CB	QBSS390CB	$I_v=40\text{mcd typ. @ } I_F=5\text{mA} / (X,Y)=(0.17,0.14)$	1000

Revision History

Description:	Revision #	Revision Date
New Release of QBSS39ZCX	V1.0	04/03/2018

Disclaimer

QT-BRIGHTTEK reserves the right to make changes without further notice to any products herein to improve reliability, function or design. QT-BRIGHTTEK does not assume any liability arising out of the application or use of any product or circuit described herein; neither does it convey any license under its patent rights, nor the rights of others.

Life Support Policy

QT-BRIGHTTEK's products are not authorized for use as critical components in life support devices or systems without the express written approval of QT-BRIGHTTEK. As used herein:

1. Life support devices or systems are devices or systems which, (a) are intended for surgical implant into the body, or (b) support or sustain life, and (c) whose failure to perform when properly used in accordance with instructions for use provided in the labeling, can be reasonably expected to result in a significant injury of the user.
2. A critical component in any component of a life support device or system whose failure to perform can be reasonably expected to cause the failure of the life support device or system, or to affect its safety or effectiveness.

Product: QBSS39ZCX	Date: April 03, 2018	Page 13 of 13
	Version# 1.0	