



May. 2021 Ver.3.0
TDK Corporation

Multilayer Diplexer

For LTE

DPX Series 2.5x2.0mm [EIA 1008] TYPE

P/N: **DPX252690DT-5072A1**

DPX252690DT-5072A1

■ SHAPES AND DIMENSIONS

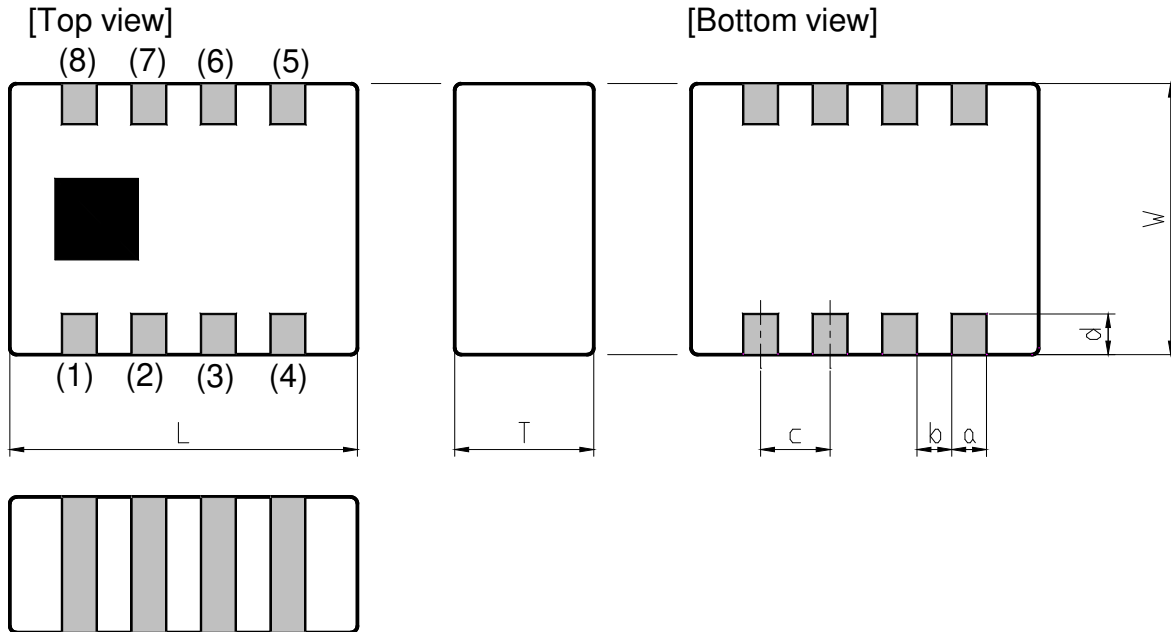

Dimensions (mm)

L	W	T	a	b	c	d
2.50	2.00	0.65	0.25	0.25	0.50	0.20
+/-0.15	+/-0.15	Max	+/-0.15	+/-0.15	+/-0.15	+/-0.15

Terminal functions

(1)	GND
(2)	GND
(3)	Common Port
(4)	GND
(5)	High-Band Port

(6)	GND
(7)	GND
(8)	Low-Band Port

■ TERMINATION FINISH

Material
Sn plate

DPX252690DT-5072A1

■ ELECTRICAL CHARACTERISTICS

(Measurement)

Low-Band

Parameter	Frequency (MHz)	TDK Spec.		
		Min.	Typ.	Max.
Insertion Loss (dB)	617 to 960	-	0.34	0.42
Insertion Loss (dB) (-40 to +90 °C)	617 to 960	-	-	0.52
	to	-	-	-
Return Loss (dB) (Low-Band Port)	617 to 960	16	20	-
	to	-	-	-
Attenuation (dB)	1427 to 1463	22	27	-
	1452 to 1496	22	32	-
	1463 to 1496	22	32	-
	1496 to 1511	25	31	-
	1554 to 1605	22	26	-
	1695 to 1710	22	25	-
	1710 to 1850	22	25	-
	1760 to 1850	22	25	-
	1850 to 2108	22	26	-
	2109 to 2200	24	29	-
	2300 to 2400	25	32	-
	2401 to 2496	25	33	-
	2496 to 2586	25	33	-
	2620 to 2745	25	34	-
	3400 to 3800	30	39	-
5150 to 5925	25	32	-	
5926 to 12750	-	10	-	
Characteristic Impedance (ohm)		50 (Nominal)		

Ta = +25+/-5°C

DPX252690DT-5072A1

■ ELECTRICAL CHARACTERISTICS

(Measurement)

High-Band

Parameter	Frequency (MHz)	TDK Spec		
		Min.	Typ.	Max.
Insertion Loss (dB)	1452 to 1496	-	0.63	0.75
	1710 to 1995	-	0.42	0.60
	2010 to 2690	-	0.57	0.70
Insertion Loss (dB) (-40 to +90 °C)	1452 to 1496	-	-	0.85
	1710 to 1995	-	-	0.70
	2010 to 2690	-	-	0.85
Return Loss (dB) (High-Band Port)	1452 to 1496	15	24	-
	1710 to 1995	12	17	-
	2010 to 2690	12	17	-
Attenuation (dB)	617 to 915	25	27	-
	915 to 960	24.5	27	-
	3400 to 3600	20	21	-
	3600 to 3800	20	21	-
	3800 to 5130	20	22	-
	5130 to 5925	28	38	-
	5925 to 12750	-	5	-
Characteristic Impedance (ohm)		50 (Nominal)		

 $T_a = +25 \pm 5^\circ\text{C}$

DPX252690DT-5072A1

■ ELECTRICAL CHARACTERISTICS

(Measurement)

Common

Parameter	Frequency (MHz)	TDK Spec TBD		
		Min.	Typ.	Max.
Isolation (dB)	617 to 960	24	26	-
	1452 to 1496	25	37	-
	1710 to 1805	24	26	-
	1830 to 2690	24.5	26	-
Return Loss (dB) (Common Port)	617 to 960	17	20	-
	1452 to 1496	15	22	-
	1710 to 1995	12	16	-
	2010 to 2690	12	16	-
Characteristic Impedance (ohm)		50 (Nominal)		

Ta = +25+/-5°C

■ MAXIMUM RATINGS

Parameter		TDK Spec	Conditions
Operating temperature (°C)		-40 to +90 °C	
Storage temperature (°C)		-40 to +90 °C	
Power Handling (W) *1	Frequency (MHz)		
	Common Port	617 to 960	Duty 50%
		1452 to 2690	CW
	Low-Band	617 to 960	Duty 50%
High-Band	1452 to 2690	CW	
Human Body Model : HBM	@Each Port (V)	+/-1000	100pF / 1500ohm
Machine Model : MM	@Each Port (V)	+/-150	200pF / 0ohm
Charged Device Model : CDM	@Each Port (V)	+/-500	Humidity : 60%RH max

*1 : Refer to 3GPP TS 38.101-1 V15.2.0

DPX252690DT-5072A1

FREQUENCY CHARACTERISTICS

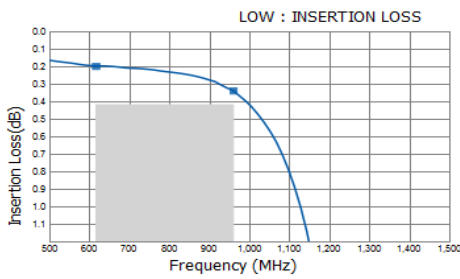

P/N	DPX252690DT-
Freq	5072A1_Ver_1_1_N_20171208
617	0.20
960	0.34

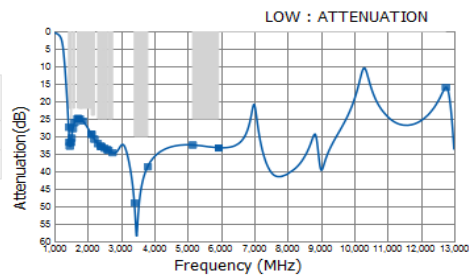

P/N	DPX252690DT-
Freq	5072A1_Ver_1_1_N_20171208
1427	27.39
1452	31.66
1463	32.80
1496	31.78
1511	30.53
1554	27.81
1605	26.07
1695	24.95
1710	24.90
1760	24.95
1850	25.59
2108	29.38
2109	29.39
2200	30.82
2300	32.09
2400	32.90
2401	32.91
2496	33.39
2586	33.81
2620	33.98
2745	34.66
3400	49.01
3800	38.68
5150	32.49
5925	33.27
5926	33.27
12750	16.01

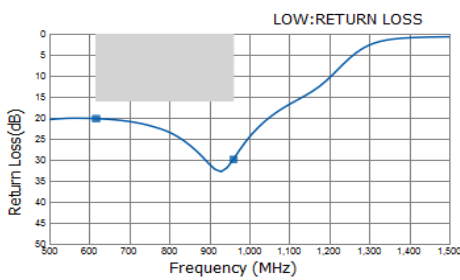

P/N	DPX252690DT-
Freq	5072A1_Ver_1_1_N_20171208
617	20.20
960	29.92

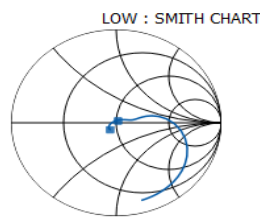

P/N	DPX252690DT-
Freq	5072A1_Ver_1_1_N_20171208
617	-0.07 / -0.07
960	0.01 / 0.03

DPX252690DT-5072A1

FREQUENCY CHARACTERISTICS

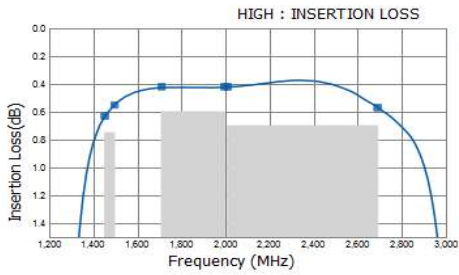

P/N	DPX252690DT-5072A1_Ver_1_1_N_20171208
Freq	
1452	0.63
1496	0.55
1710	0.42
1995	0.42
2010	0.42
2690	0.57

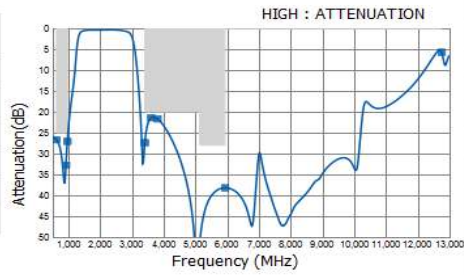

P/N	DPX252690DT-5072A1_Ver_1_1_N_20171208
Freq	
617	26.66
915	32.74
960	27.08
3400	27.39
3600	21.40
3800	21.67
5130	51.58
5925	38.21
12750	5.73

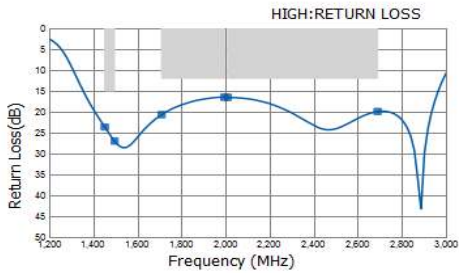

P/N	DPX252690DT-5072A1_Ver_1_1_N_20171208
Freq	
1452	23.62
1496	27.01
1710	20.68
1995	16.52
2010	16.54
2690	19.93

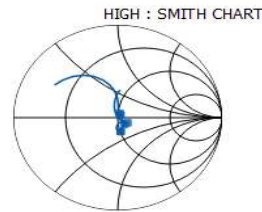

P/N	DPX252690DT-5072A1_Ver_1_1_N_20171208
Freq	
1452	0.01 / 0.06
1496	0.02 / 0.04
1710	0.06 / -0.07
1995	0.02 / -0.15
2010	0.02 / -0.15
2690	0.09 / -0.05

DPX252690DT-5072A1

■ FREQUENCY CHARACTERISTICS

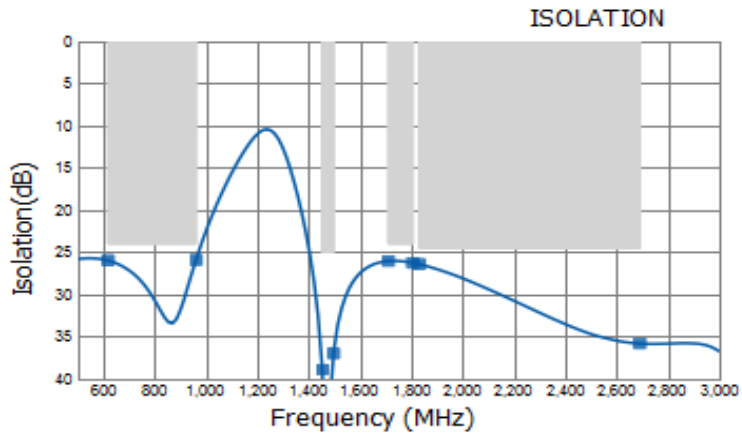

P/N	DPX252690DT-
Freq	5072A1_Ver_1_1_N_20171208
617	25.94
960	25.89
1452	38.85
1496	36.96
1710	26.01
1805	26.22
1830	26.38
2690	35.78

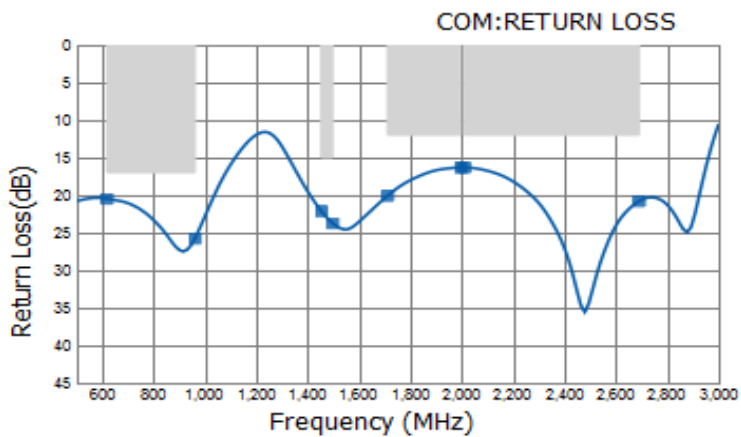

P/N	DPX252690DT-
Freq	5072A1_Ver_1_1_N_20171208
617	20.48
960	25.77
1452	22.12
1496	23.73
1710	20.08
1995	16.33
2010	16.32
2690	20.79

DPX252690DT-5072A1

RECOMMENDED LAND PATTERN

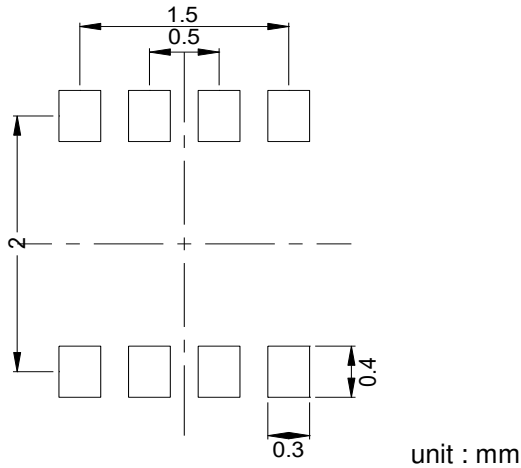

EVALUATION BOARD

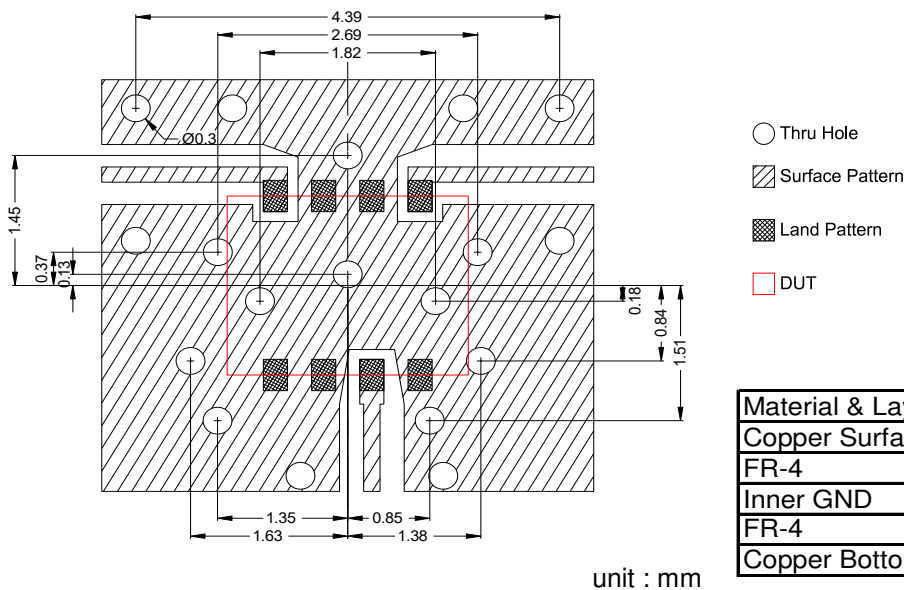

- Thru Hole
- Surface Pattern
- Land Pattern
- DUT

Material & Layer	Thickness
Copper Surface Pattern	0.035 mm
FR-4	0.10 mm
Inner GND	0.018 mm
FR-4	0.30 mm
Copper Bottom GND	0.035 mm

* Line width should be designed to match 50 ohm characteristic impedance depending on PCB material and thickness.

** The position of the thru hole which have possibility of influence to the performance are indicated by dimension line.

ENVIRONMENT INFORMATION

RoHS Statement
RoHS Compliance

DPX252690DT-5072A1

RECOMMENDED REFLOW PROFILE

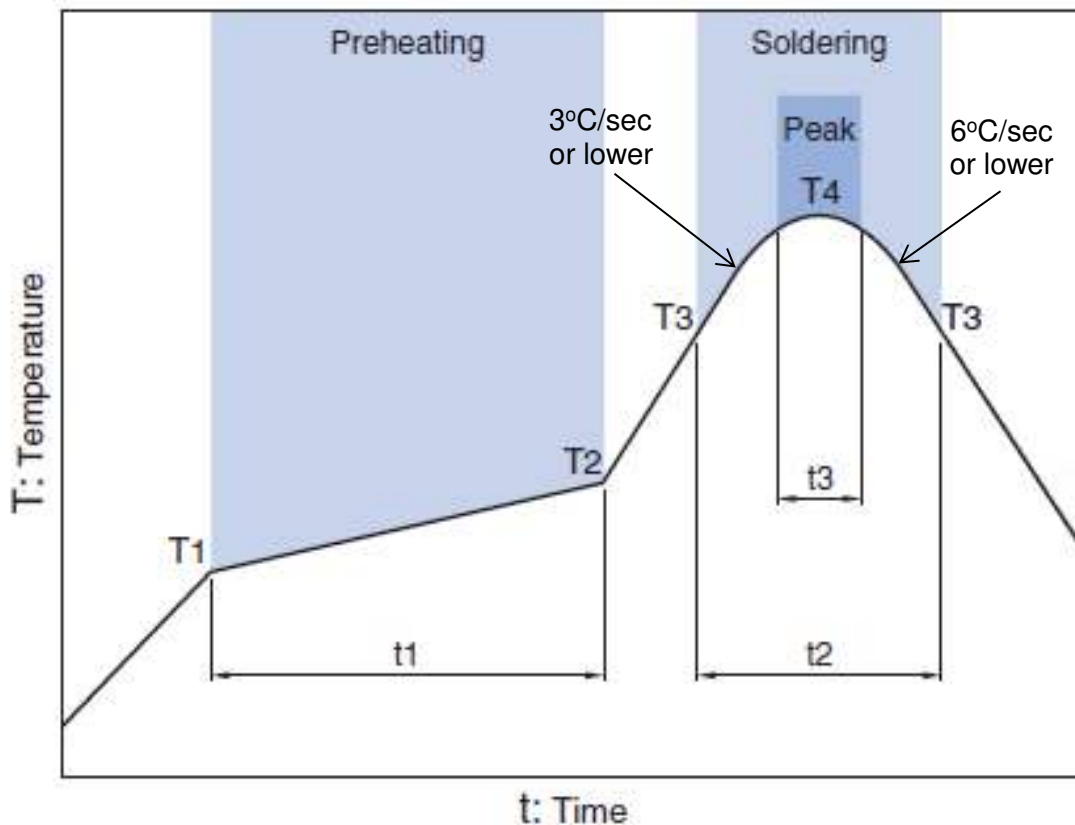

Preheating			Soldering			
Temp.		Time	Critical zone (T3 to T4)		Peak	
T1	T2	t1	T3	t2	T4	t3 *
150°C	200°C	60 to 120sec	217°C	60 to 120sec	240 to 260°C	30 sec Max

* t3 : Time within 5°C of actual peak temperature

The maximum number of reflow is 3.

Note: Lead free solder is recommended.
Recommended solder is Sn-3.0Ag-0.5Cu. (M705 by Senju Metal Industry)

DPX252690DT-5072A1**PACKAGING STYLE**

Reel Dimensions

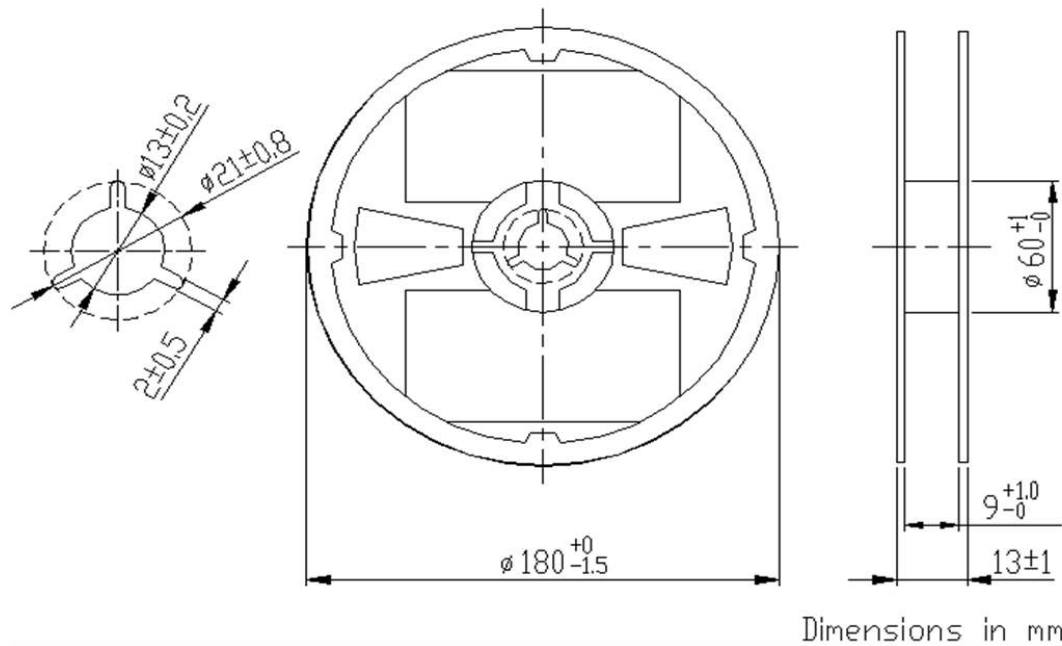

Carrier Tape

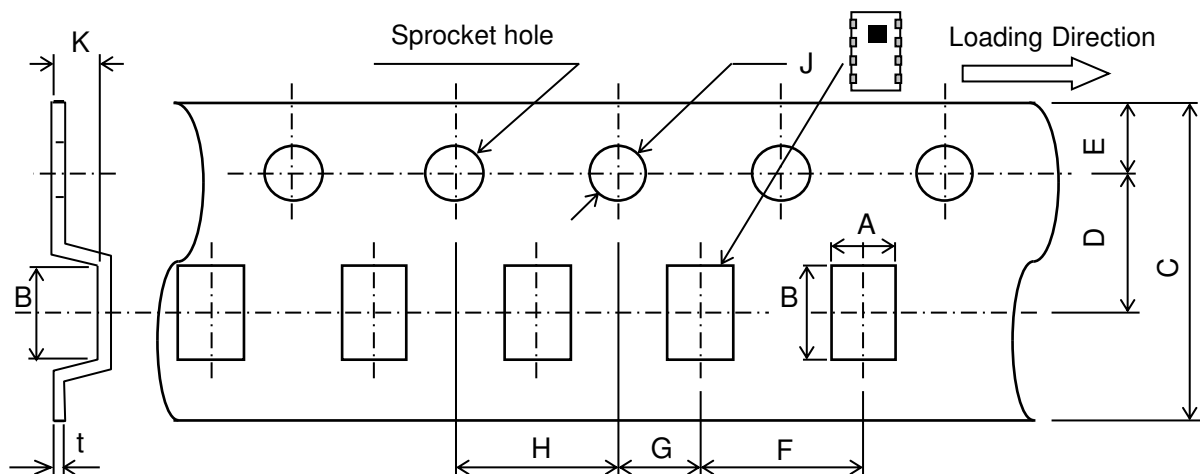

Dimensions (mm)

A	B	C	D	E	F	G	H	J	K	t
2.2	2.7	8.0	3.5	1.75	4.0	2.0	4.0	1.5	0.85	0.25
+/-0.05	+/-0.05	+0.3/-0.1	+/-0.05	+/-0.1	+/-0.1	+/-0.05	+/-0.1	+0.1/-0	MAX	+/-0.05

STANDARD PACKAGE QUANTITY (pieces/reel)
2,000

REMINDERS FOR USING THESE PRODUCTS

Before using these products, be sure to request the delivery specifications.

SAFETY REMINDERS

Please pay sufficient attention to the warnings for safe designing when using these products.

 REMINDERS
--

The products listed on this specification sheet are intended for use in general electronic equipment (AV equipment, telecommunications equipment, home appliances, amusement equipment, computer equipment, personal equipment, office equipment, measurement equipment, industrial robots) under a normal operation and use condition.

The products are not designed or warranted to meet the requirements of the applications listed below, whose performance and/or quality require a more stringent level of safety or reliability, or whose failure, malfunction or trouble could cause serious damage to society, person or property. Please understand that we are not responsible for any damage or liability caused by use of the products in any of the applications below or for any other use exceeding the range or conditions set forth in this specification sheet.

1. Aerospace/Aviation equipment
2. Transportation equipment (cars, electric trains, ships, etc.)
3. Medical equipment
4. Power-generation control equipment
5. Atomic energy-related equipment
6. Seabed equipment
7. Transportation control equipment
8. Public information-processing equipment
9. Military equipment
10. Electric heating apparatus, burning equipment
11. Disaster prevention/crime prevention equipment
12. Safety equipment
13. Other applications that are not considered general-purpose applications

When using this product in general-purpose applications, you are kindly requested to take into consideration securing protection circuit/equipment or providing backup circuits, etc., to ensure higher safety.