

REV.	DESCRIPTION	DATE	APPROVED
A	Engineering Release.	10/15/03	M. C.
B	Updated TO-21 ID.	09/05/06	M. C.
C	Updated Part Thickness Offered.	09/08/10	T. Y.
D	Corrected TO-13 OD Typo.	07/03/12	T. Y.
E	Added Figure H.	07/18/12	T. Y.
F	Removed Part Numbers from Part Offering, Table 1	07/01/14	J. C.
G	Removed Part Numbers, See Page 2	03/06/15	J. C.
H	Add Part Number, See Page 2	03/31/15	J. C.

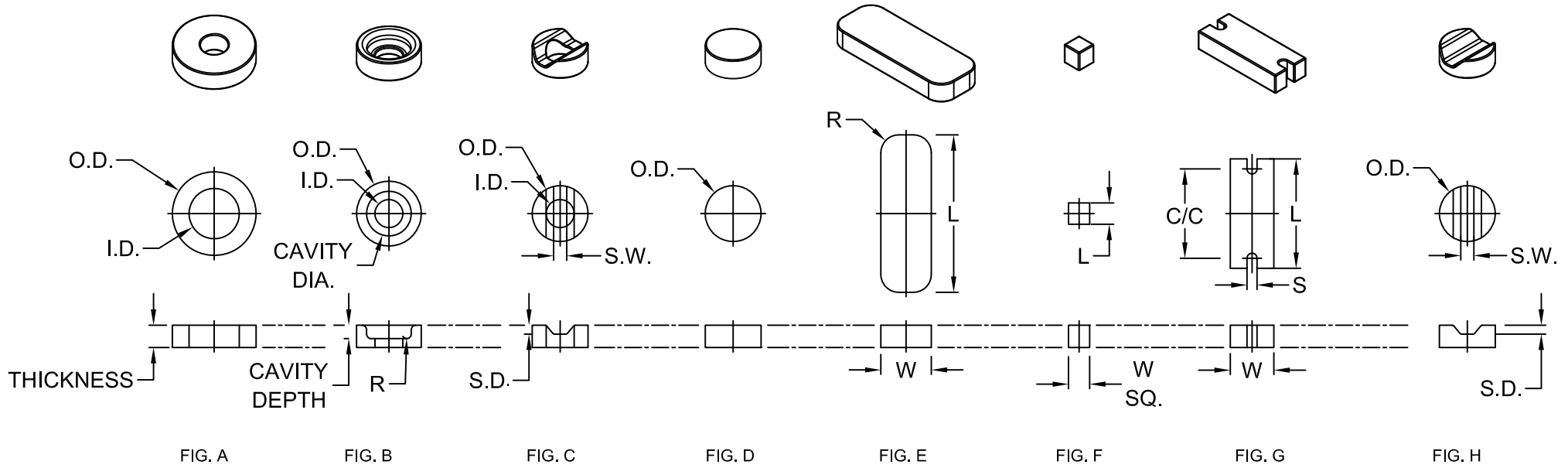

EXAMPLE:

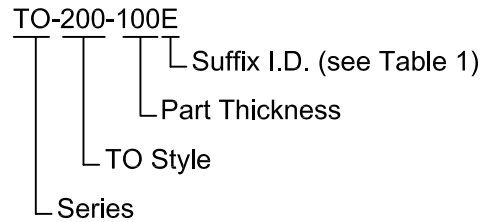

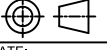

TABLE 1

SUFFIX I.D.	I.D. DESCRIPTION	NOTES
NONE	Wax	Offered for all part numbers.
E	Effervescent	Offered for all part numbers.
CR	Color Removed	Offered for all part numbers.
DR	Detergent Removed	Offered for all part numbers.
H	Salt	Not offered for P/Ns: TO-10, TO-11, TO-64, TO-65, TO-68.
XH	Extra Hard	Not offered for P/Ns: TO-10, TO-11, TO-64, TO-65, TO-68.

STANDARD TOLERANCE (UNLESS OTHERWISE SPECIFIED)		 BIVAR [®] 4 THOMAS, IRVINE, CA. 92618 TEL: (949) 951-8808 FAX: (949) 951-3974
DECIMALS	ANGULAR	
.X ±.1	X° ± 1°	
.XX ±.01		 TITLE: DISS-O-PADS, WASH-AWAY SPACERS
.XXX ±.005		
DESIGNED: D. Green	DATE: 10/15/03	PART NO: TO-XXX-XXX REVISION: H
CHECKED: Michael Chen	DATE: 10/15/03	
		CAGE CODE : 32559 SHEET # 1 OF 3 CAD GENERATED DOCUMENT. DO NOT MEASURE DRAWING.

REV	DESCRIPTION	DATE	APPROVED
	SEE SHEET #1.		

TO-5

PART NO.	I.D.	O.D.	THICKNESS	FIG.	TO-5
TO-5	.225 (5.7mm)	.375 (9.5mm)	.030, .040, .050, .060, .070, .085, .090, .100, .120, .130, .150, .170, .200	A	Spacer
TO-6	.250 (6.4mm)	.375 (9.5mm)	.030, .040, .050, .060, .070, .090, .100, .120, .130, .150, .160, .180, .190	A	I.C. Spacer
TO-9	.300 (7.8mm)	.437 (11.1mm)	.030, .040, .050, .070, .080, .090, .100, .120, .130, .150, .180, .200	A	-
TO-13	.225 (5.7mm)	.310 (7.9mm)	.030, .040, .050, .060, .070, .080, .090, .100, .120, .130, .150	A	Epoxy Case

TO-18

PART NO.	I.D.	O.D.	CAVITY DIA.	CAVITY DEPTH	THICKNESS	FIG.	TO-18
TO-12	.125 (3.2mm)	.310 (7.9mm)	.215 (5.5mm)	.065 (1.7mm)	.080, .090, .100, .120, .130, .180	B	.250 (6.4mm) L.S.
TO-16	.125 (3.2mm)	.205 (5.2mm)	-	-	.030, .040, .045, .050, .060, .070, .080, .090, .100, .120, .130, .150, .175, .200	A	Epoxy Case
TO-17	.170 (4.3mm)	.250 (6.4mm)	-	-	.030, .035, .040, .050, .060, .070, .090, .100, .120, .130, .140, .150, .170, .180, .200	A	Thin Walls
TO-18	.125 (3.2mm)	.250 (6.4mm)	-	-	.030, .040, .045, .050, .055, .060, .070, .080, .090, .100, .120, .125, .130, .150, .170, .190, .200, .250	A	Standard
TO-20	.125 (3.2mm)	.290 (7.4mm)	.200 (5.1mm)	.065 (1.7mm)	.070, .090, .100, .120, .130, .150	B	.200 (5.1mm) L.S.
TO-27	.125 (3.2mm)	.290 (7.4mm)	-	-	.030, .040, .050, .060, .070, .090, .100, .120, .130	A	Heavy Walls

AXIAL

PART NO.	I.D.	O.D.	THICKNESS	SLOT DEPTH	SLOT WIDTH	FIG.
TO-21	.125 (3.2mm)	.250 (6.4mm)	.050, .070, .080, .090, .100, .120, .130, .150, .170, .200, .230, .250	.045 (1.1mm)	.060 (1.5mm)	C
TO-35	-	.440 (11.2mm)	.100, .120, .130, .140, .150, .170, .180, .190, .220, .230, .250	.065 (1.7mm)	.230 (5.8mm)	H
TO-36	-	.187 (4.7mm)	.050, .060, .070, .080, .090, .100, .120, .130, .150	.040 (1.0mm)	.080 (2.0mm)	H
TO-37	-	.156 (4.0mm)	.050, .070, .080, .090, .100, .120	.025 (.64mm)	.050 (1.3mm)	H

ON-END/CORDWOOD

PART NO.	I.D.	O.D.	CAVITY DIA.	CAVITY DEPTH	THICKNESS	FIG.
TO-7	.075 (1.9mm)	.175 (4.4mm)	-	-	.030, .040, .050, .060, .070, .090, .100, .120, .130, .150, .180, .210	A
TO-8	.062 (1.6mm)	.156 (4.0mm)	-	-	.030, .035, .040, .050, .055, .060, .065, .070, .080, .085, .090, .100, .105, .120, .130, .150, .160, .190, .200, .210	A
TO-10	.040 (1.0mm)	.085 (2.2mm)	-	-	.025, .030, .040, .050, .060, .065, .070, .080, .090, .100	A
TO-11	.045 (1.1mm)	.100 (2.5mm)	-	-	.030, .040, .050, .060, .070, .080, .100, .110, .120	A
TO-26	.070 (1.8mm)	.187 (4.7mm)	-	-	.030, .040, .050, .060, .070, .090, .100, .120, .125, .150	A
TO-40	.045 (1.1mm)	.156 (4.0mm)	-	-	.030, .040, .050, .060, .070, .080, .090, .100, .120, .130, .150, .160	A
TO-64	.045 (1.1mm)	.140 (3.6mm)	-	-	.030, .035, .040, .050, .060, .070, .090, .100, .120, .125, .130, .140, .150, .160, .175	A
TO-65	.075 (1.9mm)	.140 (3.6mm)	-	-	.030, .035, .040, .045, .050, .060, .070, .080, .090, .100, .120, .125, .130, .150, .175	A
TO-67	.045 (1.1mm)	.140 (3.6mm)	.090 (2.3mm)	.025 (.64mm)	.050, .055, .060, .070, .090, .100, .120, .130	B
TO-68	.045 (1.1mm)	.110 (2.8mm)	.075 (1.9mm)	.025 (.64mm)	.040, .050, .055, .060, .070, .090, .100, .120, .130, .150, .160	B

SOLID

PART NO.	I.D.	O.D.	THICKNESS	FIG.
TO-29	-	.156 (4.0mm)	.040, .050, .060, .070, .090, .100, .120, .130	D
TO-31	-	.125 (3.2mm)	.040, .050, .060, .070, .090, .100, .120, .130	D
TO-32	-	.187 (4.7mm)	.030, .040, .050, .060, .070, .080, .090, .100, .120, .130	D
TO-33	-	.250 (6.4mm)	.030, .040, .050, .060, .070, .080, .090, .100, .120, .130	D
TO-34	-	.375 (9.5mm)	.040, .050, .060, .070, .090, .100, .120, .130, .250	D

STANDARD TOLERANCE (UNLESS OTHERWISE SPECIFIED)		 BIVAR [®] 4 THOMAS, IRVINE, CA. 92618 TEL: (949) 951-8808 FAX: (949) 951-3974
DECIMALS .X ± .1 .XX ± .01 .XXX ± .005	ANGULAR X° ± 1°	
DESIGNED: D. Green CHECKED: Michael Chen		DATE: 10/15/03 DATE: 10/15/03
TITLE: DISS-O-PADS, WASH-AWAY SPACERS		PART NO: TO-XXX-XXX REVISION: H CAGE CODE : 32559 SHEET # 2 OF 3 CAD GENERATED DOCUMENT, DO NOT MEASURE DRAWING.

REV	DESCRIPTION	DATE	APPROVED
	SEE SHEET #1.		

GENERAL PURPOSE



PART NO.	I.D.	O.D.	THICKNESS	FIG.
TO-46	.090 (2.3mm)	.250 (6.4mm)	.030, .040, .050, .060, .070, .090, .100, .120, .130, .150, .200, .240	A
TO-19	.250 (6.4mm)	.480 (12.2mm)	.030, .040, .050, .060, .070, .090, .100, .120, .130, .150, .190, .200, .230, .250	A
TO-22	.225 (5.7mm)	.437 (11.1mm)	.030, .040, .050, .060, .070, .080, .090, .100, .110, .120, .130, .150, .190, .200, .250	A
TO-23	.090 (2.3mm)	.310 (7.9mm)	.030, .040, .050, .055, .060, .070, .090, .100, .120, .130, .150, .180, .190, .200, .250	A
TO-24	.090 (2.3mm)	.340 (8.6mm)	.030, .040, .050, .060, .070, .090, .100, .120, .130, .150	A
TO-30	.275 (7.0mm)	.397 (10.0mm)	.030, .040, .050, .060, .070, .090, .100, .120, .130, .150	A
TO-25	.180 (4.6mm)	.480 (12.2mm)	.030, .040, .050, .060, .070, .090, .100, .120, .130, .150, .250	A
TO-28	.172 (4.4mm)	.343 (8.7mm)	.030, .040, .050, .060, .070, .090, .100, .120, .130, .180, .190	A
TO-41	.156 (4.0mm)	.360 (9.1mm)	.030, .040, .050, .060, .070, .090, .100, .120, .130, .140	A
TO-42	.250 (6.4mm)	.438 (11.1mm)	.030, .040, .050, .060, .070, .090, .100, .120, .130	A

RECTANGULAR & SQUARE

PART NO.	L	W	R	THICKNESS	FIG.	
TO-100	.670 (17.0mm)	.100 (2.5mm)	.031 (.79mm)	.030, .035, .040, .045, .050, .060, .065, .070, .075, .080, .090, .100, .120, .130, .150, .200	E	Rectangular
TO-101	.562 (14.3mm)	.185 (4.7mm)	-	.030, .040, .050, .060, .070, .080, .090, .100, .120, .130, .150, .160, .220	E	Rectangular
TO-102	.505 (12.8mm)	.160 (4.1mm)	-	.040, .050, .060, .070, .090, .100, .120, .130, .150	E	Rectangular
TO-116	.666 (16.9mm)	.300 (7.8mm)	.063 (1.6mm)	.030, .040, .050, .055, .060, .065, .070, .075, .080, .090, .100, .110, .120, .125, .130, .150, .180, .200	E	Rectangular
TO-117	.666 (16.9mm)	.281 (7.1mm)	.100 (2.54mm)	.030, .040, .050, .060, .070, .080, .090, .100, .120, .125, .130, .140, .150, .160	E	Rectangular
TO-118	.705 (17.9mm)	.260 (6.6mm)	.080 (2.0mm)	.030, .040, .050, .060, .070, .080, .090, .100, .110, .120, .130, .150, .160, .170, .175, .200	E	Rectangular
TO-120	.085 (2.2mm)	.085 (2.2mm)	-	.030, .035, .040, .045, .050, .060, .070, .090, .100, .120	F	Square
TO-121	.095 (2.4mm)	.095 (2.4mm)	-	.030, .035, .040, .045, .050, .060, .070, .075, .085, .090, .095, .100, .120	F	Square

RADIAL & AXIAL DEVICE

PART NO.	C/C	S	W	L	THICKNESS	FIG.
TO-200	.100 (2.5mm)	.035 (.89mm)	.095 (2.4mm)	.190 (4.8mm)	.030, .035, .040, .050, .060, .070, .080, .090, .100, .120, .130, .150	G
TO-201	.150 (3.8mm)	.035 (.89mm)	.095 (2.4mm)	.240 (6.1mm)	.030, .040, .050, .060, .070, .090, .100, .120, .130, .150	G
TO-203	.200 (5.1mm)	.035 (.89mm)	.095 (2.4mm)	.290 (7.4mm)	.030, .040, .050, .060, .070, .090, .100, .120, .130, .140, .150, .200	G
TO-204	.250 (6.4mm)	.040 (1.0mm)	.145 (3.7mm)	.340 (8.6mm)	.040, .050, .060, .070, .080, .090, .100, .120, .130, .150	G
TO-205	.300 (7.8mm)	.040 (1.0mm)	.145 (3.7mm)	.390 (9.9mm)	.040, .050, .060, .070, .090, .100, .120, .130, .150, .215	G
TO-206	.400 (10.2mm)	.045 (1.1mm)	.195 (5.0mm)	.490 (12.4mm)	.040, .050, .060, .070, .080, .090, .100, .120, .130, .150, .215	G
TO-207	.500 (12.7mm)	.045 (1.1mm)	.195 (5.0mm)	.590 (15.0mm)	.040, .050, .060, .070, .090, .100, .120, .130, .150	G

STANDARD TOLERANCE (UNLESS OTHERWISE SPECIFIED)		 BIVAR [®] 4 THOMAS, IRVINE, CA. 92618 TEL: (949) 951-8808 FAX: (949) 951-3974		
.X ± .1	ANGULAR X° ± 1°			
.XX ± .01		TITLE: DISS-O-PADS, WASH-AWAY SPACERS		
.XXX ± .005		DESIGNED: D. Green	DATE: 10/15/03	PART NO: TO-XXX-XXX
CHECKED: Michael Chen		DATE: 10/15/03	CAGE CODE : 32559	REVISION: H
			SHEET # 3 OF 3	
CAD GENERATED DOCUMENT. DO NOT MEASURE DRAWING.				