

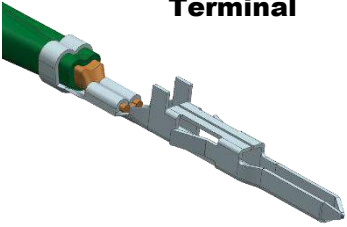
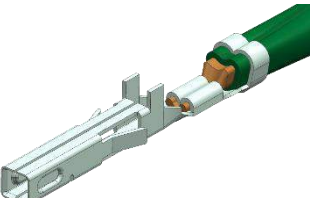
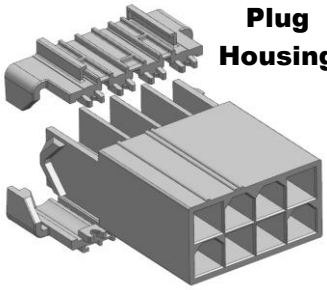
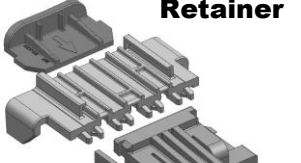
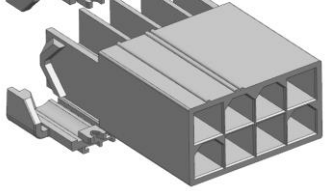
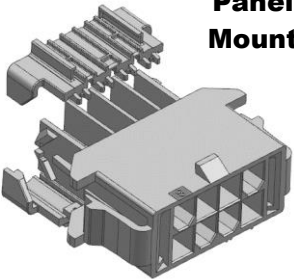

Mini-fit TPA2

INTERCONNECT SYSTEMS

Plug w/ TPA	Receptacle w/ TPA
See section 2.1 for series numbers	
<p data-bbox="613 695 781 762" style="text-align: center;">Male Crimp Terminal</p> 	<p data-bbox="878 705 1084 772" style="text-align: center;">Female Crimp Terminal</p> 
<p data-bbox="493 974 688 1003" style="text-align: center;">TPA Retainer</p> 	<p data-bbox="878 1087 1149 1157" style="text-align: center;">CPA TPA Retainer</p> 
<p data-bbox="699 1010 818 1079" style="text-align: center;">Plug Housing</p>  <p data-bbox="472 1346 818 1478" style="text-align: center;">TPA Retainer Plug Housing, Panel Mount</p> 	<p data-bbox="992 1472 1159 1541" style="text-align: center;">Receptacle Housing</p> 

REVISION: B	ECR/ECN INFORMATION: EC No: 609086 DATE: 2018/13/12	TITLE: APPLICATION SPECIFICATION FOR MINI-FIT TPA2 CONNECTOR SYSTEM	SHEET No. 1 of 12
DOCUMENT NUMBER: AS-172718-0000	CREATED / REVISED BY: sgangadhardo	CHECKED BY: mramakrishna	APPROVED BY: ishwarg

molex[®] APPLICATION SPECIFICATION

1.0 SCOPE

This Application Specification covers the performance requirements for the MINI-FIT TPA2 Wire-To-Board and Wire-To-Wire, 4.20mm pitch dual row and single row connector series using brass, phos bronze and high conductive copper alloy terminals with Tin and Gold plating terminated with 16 to 24 AWG wire using Molex crimp technology. The TPA Retainer (terminal position assurance) is intended to ensure the crimp terminals are fully seated and to prevent incidence of terminal back-out due to partially seated terminals. The connector position assurance (CPA) latch optional, will prevent connector accidental un-mating. This document is NOT intended to be the final process definition nor is it intended to constrain design.

2.0 PRODUCT DESCRIPTION

2.1 NAMES AND SERIES NUMBER(S)

WIRE-TO-BOARD				
Description	Series Number	UL (600 V)	CSA (250 V)	IEC (600 V)
Mini-Fit TPA2, Receptacle Hsg, Dual Row	172708	Yes	Yes	Yes
Mini-Fit TPA2, Receptacle Hsg, Single Row	200453	Yes	Yes	Yes
Mini-Fit TPA2, Female Crimp Terminal	172718	Yes	Yes	Yes
Mini-Fit TPA2, TPA Retainer	172709	Yes	Yes	Yes
Mini-Fit TPA2, CPA	203603	Yes	Yes	Yes

WIRE-TO-WIRE				
Description	Series Number	UL (600 V)	CSA (250 V)	IEC (600 V)
Mini-Fit TPA2, Female Crimp Terminal	172718	Yes	Yes	Yes
	202988	Yes	Yes	Yes
Mini-Fit TPA2, Receptacle Hsg, Dual Row	172708	Yes	Yes	Yes
Mini-Fit TPA2, Receptacle Hsg, Single Row	200453	Yes	Yes	Yes
Mini-Fit TPA2, TPA Retainer	172709	Yes	Yes	Yes
Mini-Fit TPA2, CPA	203603	Yes	Yes	Yes
Mini-Fit TPA2, Male Crimp Terminal	172765	Yes	Yes	Yes
	203070	Yes	Yes	Yes
Mini-Fit TPA2, Plug Hsg, Dual Row	172762	Yes	Yes	Yes
Mini-Fit TPA2, Plug Hsg, Panel Mount, Dual Row	172767	Yes	Yes	Yes
Mini-Fit TPA2, Plug Hsg, Single Row	200471	Yes	Yes	Yes
Mini-Fit TPA2, Plug Hsg, Panel Mount, Single Row	200488	Yes	Yes	Yes

2.2 DIMENSIONS, MATERIALS, PLATINGS AND MARKINGS

See the appropriate sales drawings for the information on dimensions, materials, platings and markings.

REVISION: B	ECR/ECN INFORMATION: EC No: 609086 DATE: 2018/13/12	TITLE: APPLICATION SPECIFICATION FOR MINI-FIT TPA2 CONNECTOR SYSTEM	SHEET No. 2 of 12
DOCUMENT NUMBER: AS-172718-0000	CREATED / REVISED BY: sgangadhardo	CHECKED BY: mramakrishna	APPROVED BY: ishwarg

molex[®] APPLICATION SPECIFICATION

3.0 APPLICABLE DOCUMENTS AND SPECIFICATIONS

Product Specification.....	PS-172718-0000/2029880001-PS
Receptacle Crimp Terminal Sales Drawing.....	SD-172718-0000/2029880001 PSD
Receptacle Dual Row Housing Sales Drawing.....	SD-172708-0000
Receptacle Single Row Housing Sales Drawing.....	2004530000-SD
TPA Sales Drawing.....	SD-172709-0000/1727090001-SD
CPA Sales Drawing.....	2036030000-SD
Plug Crimp Terminal Sales Drawing.....	SD-172765-0000/2030700001 PSD
Plug Dual Row Housing Sales Drawing.....	SD-172762-0000
Plug Single Row Housing Sales Drawing.....	2004710000-SD
Plug Dual Row Housing, Panel Mount Sales Drawing.....	SD-172767-0000
Plug Single Row Housing, Panel Mount Sales Drawing.....	2004880000-SD
Technical Advisory Moisturizing Nylon Connector Parts.....	AS-45499-001

4.0 GENERAL APPLICATION NOTES

Appearance:

- Parts conform to class "B" requirements of cosmetic specification PS-45499-002 except where noted on the sales drawings.

Connector Application

- This connector system is designed to mate gold plating to gold plating OR tin plating to tin plating. Never cross mate tin plated parts to gold plated parts.
- Connectors are not to be mated or unmated while circuits are live except per the current interrupt rating listed in product specification: PS-172718-0000 and 2029880001-PS.

Packaging

- Parts shall be packaged to protect against damage during handling, transit and storage. Nylon parts should remain in their original packaging until ready for use. Refer to Molex specification AS-45499-001 for moisturizing nylon connector parts.

REVISION: B	ECR/ECN INFORMATION: EC No: 609086 DATE: 2018/13/12	TITLE: APPLICATION SPECIFICATION FOR MINI-FIT TPA2 CONNECTOR SYSTEM	SHEET No. 3 of 12
DOCUMENT NUMBER: AS-172718-0000	CREATED / REVISED BY: sgangadhardo	CHECKED BY: mramakrishna	APPROVED BY: ishwarg

molex[®] APPLICATION SPECIFICATION

5.0 CRIMPED TERMINAL EXTRACTION

- Male and Female terminal extraction tool: See Molex part# 63824-6210 instructions online on website. Do not reuse terminals that have been removed with the extraction tool. The housings can be reused if it was not damaged.

6.0 TIE AND OR WIRE TWIST LOCATION

CKT Size	Dim T Min.
2-6	.50" (12.7 mm)
8	.75" (19.1 mm)
10-12	1.00" (25.4 mm)
14-16	1.34" (34.0 mm)
18-20	1.45" (37.0 mm)
22-24	1.57" (40.0 mm)

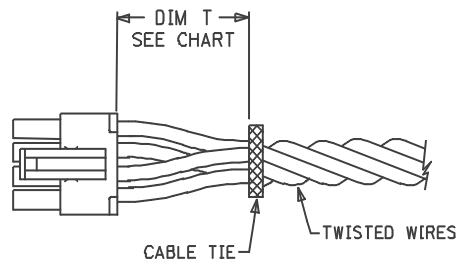

Note: Pictorial view shown for illustration purpose.

- The "T" dimension defines a "free" length of wire, or a length of wire that is not subject to significant bias by external factors such as a wire tie, wire twisting, or other means of bending or deforming of the wires that repositions them from their natural relaxed state or location where they enter the housing. This dimension is a general recommendation and may need to be adjusted for different wire gauges and wire type and insulation thickness and insulation material.
- Wires are to be dressed in such a manner to allow the terminals to float freely in the housing pocket.

7.0 CONNECTOR TESTING

- Refer the PS-177718-0000 and 2029880001-PS for information on testing.

REVISION: B	ECR/ECN INFORMATION: EC No: 609086 DATE: 2018/13/12	TITLE: APPLICATION SPECIFICATION FOR MINI-FIT TPA2 CONNECTOR SYSTEM	SHEET No. 4 of 12
DOCUMENT NUMBER: AS-172718-0000	CREATED / REVISED BY: sgangadhardo	CHECKED BY: mramakrishna	APPROVED BY: ishwarg

molex[®] APPLICATION SPECIFICATION

8.0 TERMINALS AND HOUSINGS

- 172718/202988 series terminals should only be used with Receptacle housing series' 172708 (Dual row) and 200453 (Single Row).
- 172765/203070 series terminals should only be used with Plug housing series' 172767 & 172762 (Dual row) and 200471 & 200488 (Single Row).

9.0 TERMINAL INSERTION INTO HOUSING

Terminals are to be inserted in the housing as shown below in Figure 1. Notice the orientation of the stop tabs. Do not force terminals into the housing cavity. The terminal and housing are designed with features that provide some light resistance during insertion as well as retention after insertion but if excessive resistance is felt during insertion pull terminal back out and double check that the terminal orientation is per Figure 1. Terminals are to be inserted until they are fully seated as shown in Figure 2 and cannot fall out or be pulled out easily. The terminal stop tabs provide a stopping surface and the locking tangs provide a light audible click to indicate a fully inserted terminal.

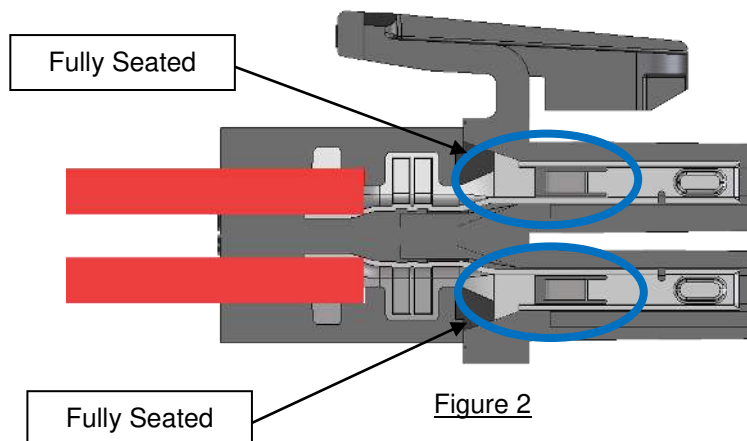
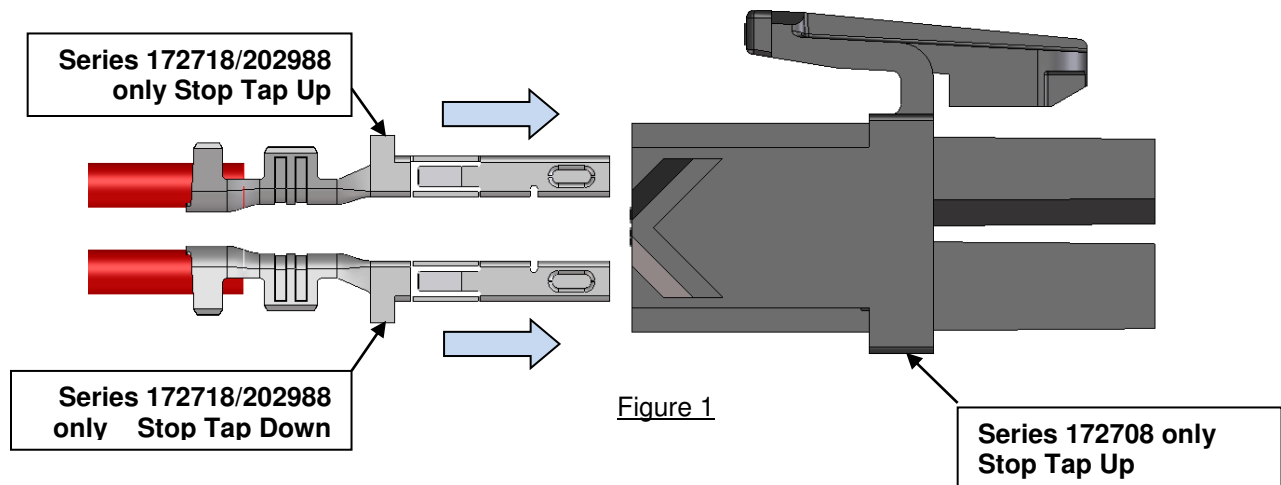

REVISION: B	ECR/ECN INFORMATION: EC No: 609086 DATE: 2018/13/12	TITLE: APPLICATION SPECIFICATION FOR MINI-FIT TPA2 CONNECTOR SYSTEM	SHEET No. 5 of 12
DOCUMENT NUMBER: AS-172718-0000	CREATED / REVISED BY: sgangadhardo	CHECKED BY: mramakrishna	APPROVED BY: ishwarg

molex[®] APPLICATION SPECIFICATION

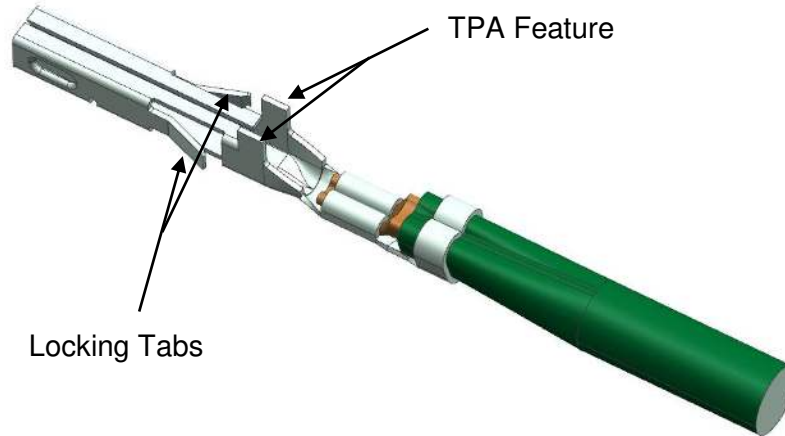

- Ensure terminals are fully seated and locked during terminal insertion to the receptacle housing.

REVISION: B	ECR/ECN INFORMATION: EC No: 609086 DATE: 2018/13/12	TITLE: APPLICATION SPECIFICATION FOR MINI-FIT TPA2 CONNECTOR SYSTEM	SHEET No. 6 of 12
DOCUMENT NUMBER: AS-172718-0000	CREATED / REVISED BY: sgangadhardo	CHECKED BY: mramakrishna	APPROVED BY: ishwarg

molex[®] APPLICATION SPECIFICATION

10.0 MINIFIT TPA2 PLUG HOUSING INSERTION INTO PANEL CUTOUT

Sharp edges on the Panel cutout will restrict or will make plug housing insertion difficult. Hence sharp edges need to be removed before inserting the plug housing parts as shown in below images.

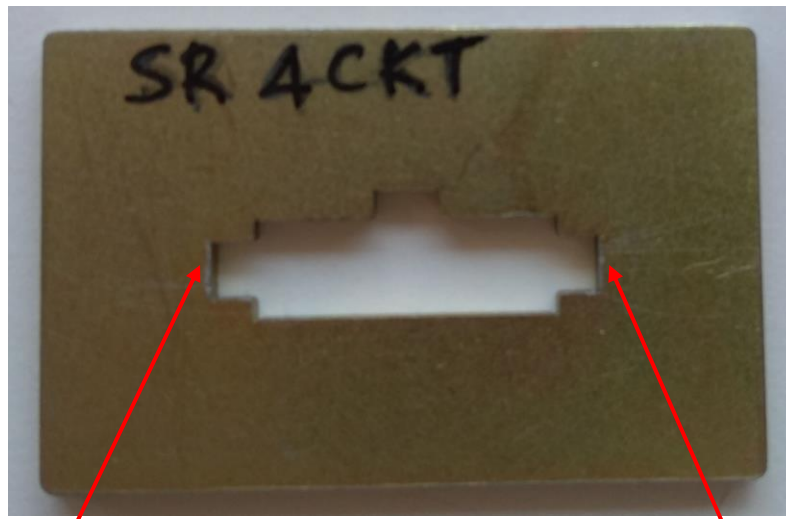
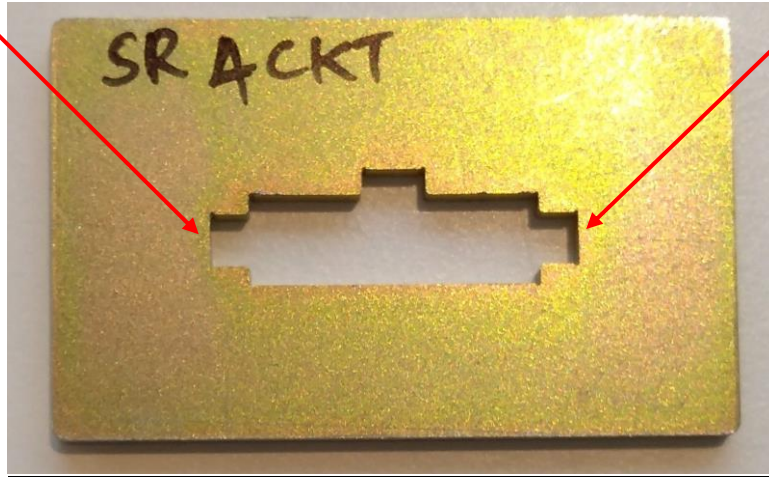

Sharp corners removed at latch insertion area

REVISION: B	ECR/ECN INFORMATION: EC No: 609086 DATE: 2018/13/12	TITLE: APPLICATION SPECIFICATION FOR MINI-FIT TPA2 CONNECTOR SYSTEM	SHEET No. 7 of 12
DOCUMENT NUMBER: AS-172718-0000	CREATED / REVISED BY: sgangadhardo	CHECKED BY: mramakrishna	APPROVED BY: ishwarg

molex[®] APPLICATION SPECIFICATION

11.0 TPA ASSEMBLY

TPA's are to be inserted in the housing as shown below in Figure 3. The TPA's are placed into the housing at an angle and then pushed down to lock all in one motion. The TPA and housing are designed with latches and locking features that hold the TPA in place after assembly. These features, when used properly, provide an audible click to indicate proper installation. See Figures 4 and 5 for proper TPA orientation after assembly. Be sure to check that both side latches have engaged. Figure 6 shows a failure mode where only one side of the TPA was engaged. In this case just push the TPA a bit further to allow the other latch to engage. The TPA is NOT designed to increase terminal retention in the housing. It is intended to ensure the crimp terminals are fully seated and to prevent the incidence of terminal back-outs due to partially seated terminals.

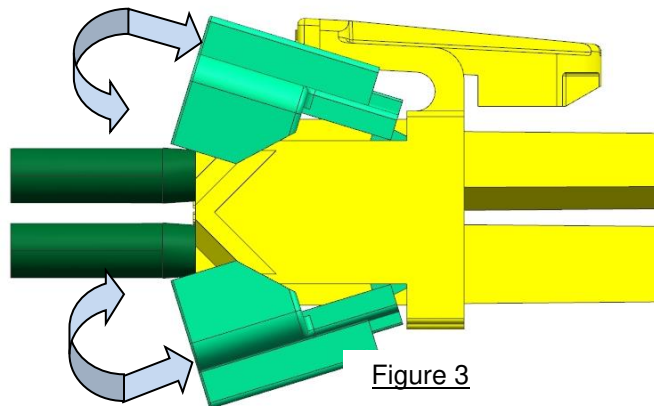

Figure 3

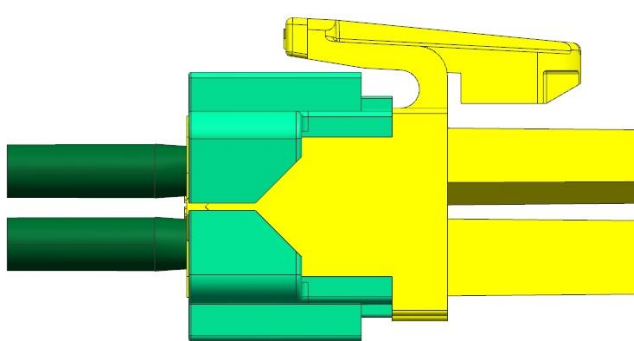

Figure 4

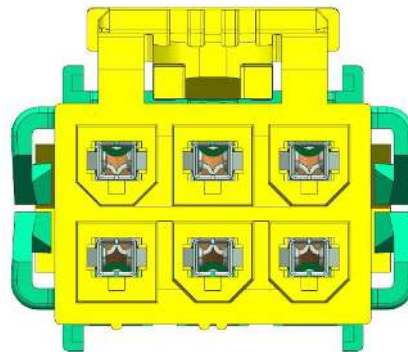

Figure 5

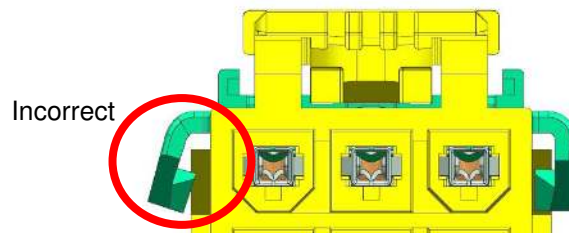

Figure 6

REVISION: B	ECR/ECN INFORMATION: EC No: 609086 DATE: 2018/13/12	TITLE: APPLICATION SPECIFICATION FOR MINI-FIT TPA2 CONNECTOR SYSTEM	SHEET No. 8 of 12
DOCUMENT NUMBER: AS-172718-0000	CREATED / REVISED BY: sgangadhardo	CHECKED BY: mramakrishna	APPROVED BY: ishwarg

molex[®] APPLICATION SPECIFICATION

12.0 CONNECTOR POSITION ASSURANCE (CPA)

Mini-Fit TPA 2 TPA (Series Number: 172709) is also available with a CPA part (Series Number: 203603) for added mate assurance and secure locking.

12.1 Activating the CPA

Once the plug and receptacle is fully mated with TPA, simply push the CPA from “pre-lock” to “final-lock” position until you see/feel positive engagement.

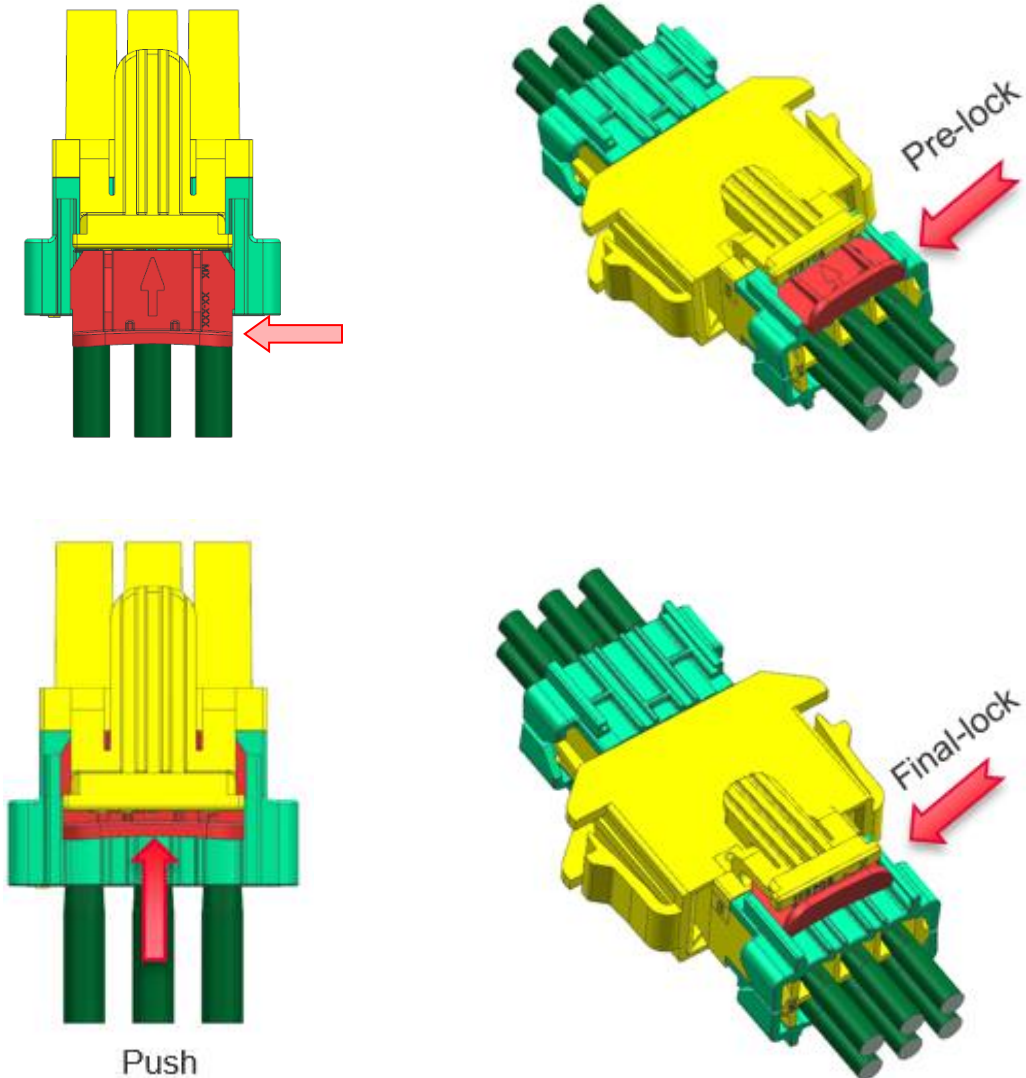

REVISION: B	ECR/ECN INFORMATION: EC No: 609086 DATE: 2018/13/12	TITLE: APPLICATION SPECIFICATION FOR MINI-FIT TPA2 CONNECTOR SYSTEM	SHEET No. 9 of 12
DOCUMENT NUMBER: AS-172718-0000	CREATED / REVISED BY: sgangadhardo	CHECKED BY: mramakrishna	APPROVED BY: ishwarg

molex® APPLICATION SPECIFICATION

12.2 Deactivating the CPA

In order to operate the latch or un-mate the connector, the CPA must be deactivated. Pull the CPA from “final-lock” condition to “pre-lock” condition with your finger. This sequence shall deactivate the CPA, allowing the user to operate the latches and proceed with the un-mating connector.

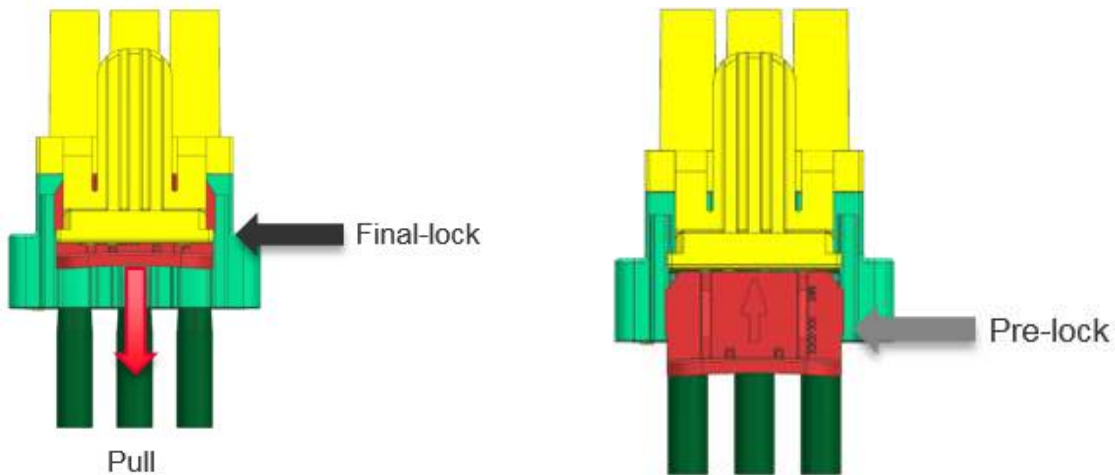

13.0 RECEPTACLE HOUSING

13.1 Crimp Terminal Appearance

- Forming marks on female terminal are normal. These are due to stretching of the plating during the forming process and are superficial cracks on the plating surface.

Forming Marks

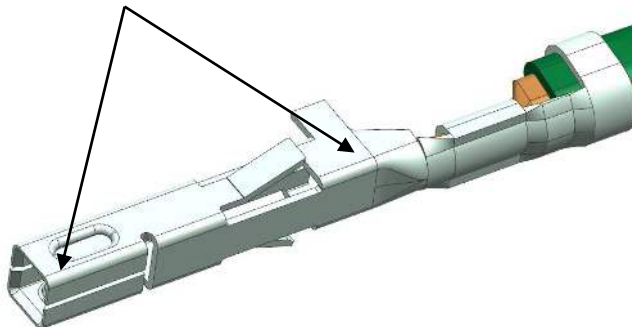

REVISION: B	ECR/ECN INFORMATION: EC No: 609086 DATE: 2018/13/12	TITLE: APPLICATION SPECIFICATION FOR MINI-FIT TPA2 CONNECTOR SYSTEM	SHEET No. 10 of 12
DOCUMENT NUMBER: AS-172718-0000	CREATED / REVISED BY: sgangadhardo	CHECKED BY: mramakrishna	APPROVED BY: ishwarg

13.2 Crimp Terminal Function

- DO NOT use terminals with damaged locking tabs or front face:



Normal Locking Tab



Collapsed Locking Tab

REVISION: B	ECR/ECN INFORMATION: EC No: 609086 DATE: 2018/13/12	TITLE: APPLICATION SPECIFICATION FOR MINI-FIT TPA2 CONNECTOR SYSTEM	SHEET No. 11 of 12
DOCUMENT NUMBER: AS-172718-0000	CREATED / REVISED BY: sgangadhardo	CHECKED BY: mramakrishna	APPROVED BY: ishwarg

molex[®] APPLICATION SPECIFICATION

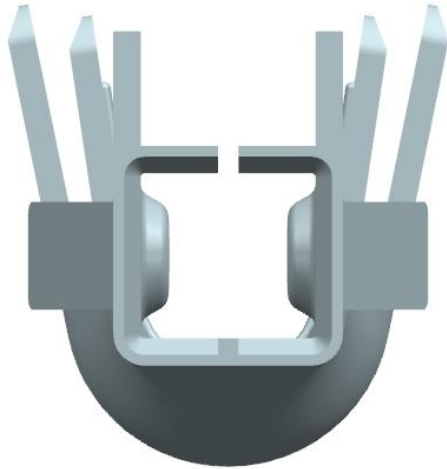

Normal Square
Front Box

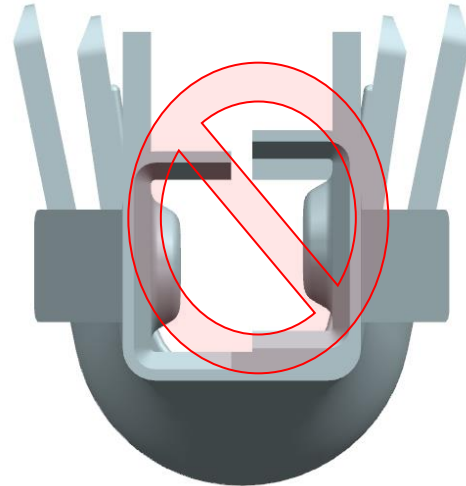

Damaged
Front Box

13.3 Crimp Terminal Handling

- Due to exposed terminal interface, keep crimp terminals on prepackaged reel until they are crimped onto wires. Store and handle crimped terminals so the interface does not make contact with other terminals or foreign objects. If terminal interface is damaged please discard prior to assembly.

Crimping

- For acceptable crimp tools and specifications see application tooling section on Molex.com listed for each terminal part number.
- Use with multi strand wire only. Single strand wire should not be used.
- Male and female crimp terminals are designed for single wire crimping only, no double wire crimping is allowed.
- Use only Molex specified crimp tooling, refer to Molex.com for acceptable crimp tooling. Crimped terminals must also meet Molex crimp specifications. Using crimp tooling/specifications other than specified voids any product warranties and will negatively impact mechanical and electrical performance.

REVISION: B	ECR/ECN INFORMATION: EC No: 609086 DATE: 2018/13/12	TITLE: APPLICATION SPECIFICATION FOR MINI-FIT TPA2 CONNECTOR SYSTEM	SHEET No. 12 of 12
DOCUMENT NUMBER: AS-172718-0000	CREATED / REVISED BY: sgangadhardo	CHECKED BY: mramakrishna	APPROVED BY: ishwarg