



Is Now Part of



ON Semiconductor®

To learn more about ON Semiconductor, please visit our website at
www.onsemi.com

Please note: As part of the Fairchild Semiconductor integration, some of the Fairchild orderable part numbers will need to change in order to meet ON Semiconductor's system requirements. Since the ON Semiconductor product management systems do not have the ability to manage part nomenclature that utilizes an underscore (_), the underscore (_) in the Fairchild part numbers will be changed to a dash (-). This document may contain device numbers with an underscore (_). Please check the ON Semiconductor website to verify the updated device numbers. The most current and up-to-date ordering information can be found at www.onsemi.com. Please email any questions regarding the system integration to Fairchild_questions@onsemi.com.

ON Semiconductor and the ON Semiconductor logo are trademarks of Semiconductor Components Industries, LLC dba ON Semiconductor or its subsidiaries in the United States and/or other countries. ON Semiconductor owns the rights to a number of patents, trademarks, copyrights, trade secrets, and other intellectual property. A listing of ON Semiconductor's product/patent coverage may be accessed at www.onsemi.com/site/pdf/Patent-Marking.pdf. ON Semiconductor reserves the right to make changes without further notice to any products herein. ON Semiconductor makes no warranty, representation or guarantee regarding the suitability of its products for any particular purpose, nor does ON Semiconductor assume any liability arising out of the application or use of any product or circuit, and specifically disclaims any and all liability, including without limitation special, consequential or incidental damages. Buyer is responsible for its products and applications using ON Semiconductor products, including compliance with all laws, regulations and safety requirements or standards, regardless of any support or applications information provided by ON Semiconductor. "Typical" parameters which may be provided in ON Semiconductor data sheets and/or specifications can and do vary in different applications and actual performance may vary over time. All operating parameters, including "Typicals" must be validated for each customer application by customer's technical experts. ON Semiconductor does not convey any license under its patent rights nor the rights of others. ON Semiconductor products are not designed, intended, or authorized for use as a critical component in life support systems or any FDA Class 3 medical devices or medical devices with a same or similar classification in a foreign jurisdiction or any devices intended for implantation in the human body. Should Buyer purchase or use ON Semiconductor products for any such unintended or unauthorized application, Buyer shall indemnify and hold ON Semiconductor and its officers, employees, subsidiaries, affiliates, and distributors harmless against all claims, costs, damages, and expenses, and reasonable attorney fees arising out of, directly or indirectly, any claim of personal injury or death associated with such unintended or unauthorized use, even if such claim alleges that ON Semiconductor was negligent regarding the design or manufacture of the part. ON Semiconductor is an Equal Opportunity/Affirmative Action Employer. This literature is subject to all applicable copyright laws and is not for resale in any manner.



ON Semiconductor®

June 2017

FAN48611 2.5 MHz, Fixed-Output, Synchronous Tiny Boost® Regulator

Features

- Input Voltage Range: 2.7 V to 4.8 V
- Output Voltage: 5.25 V
- 350 mA Maximum Output Current
- Internal Synchronous Rectification
- True Load Disconnect
- Short-Circuit Protection
- 9-Bump, 1.215 mm x 1.215 mm, 0.4 mm Pitch, WLCSP
- Three External Components: 2012 1 μ H Inductor, 0402 Case Size Input / Output Capacitors

Applications

- Class-D Audio Amplifier and USB OTG Supply
- Boost for Low-Voltage Li-Ion Batteries
- Smart Phones, Tablets, Portable Devices, and Wearables

Description

The FAN48611 is a low-power boost regulator designed to provide a minimum voltage regulated rail from a standard single-cell Li-Ion battery and advanced battery chemistries. Even below the minimum system battery voltage, the device maintains output voltage regulation. The combination of built-in power transistors, synchronous rectification, and low supply current suit the FAN48611 for battery-powered applications.

The FAN48611 is available in a 9-bump, 0.4 mm pitch, Wafer-Level Chip-Scale Package (WLCSP).

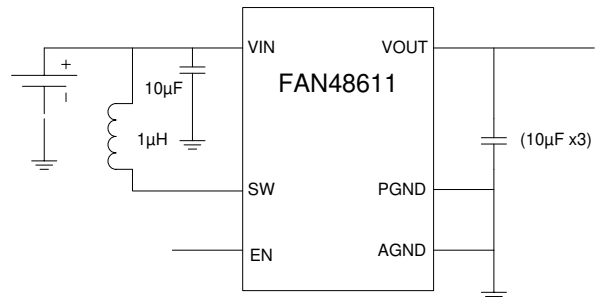

Figure 1. Typical Application

Ordering Information

Part Number	V _{OUT}	Operating Temperature Range	Package	Packing Method	Device Marking
FAN48611UC53X	5.25 V	-40°C to 85°C	9-Bump, 0.4 mm Pitch, Wafer-Level Chip-Scale Package (WLCSP)	Tape and Reel ⁽¹⁾	KH

Note:

1. Tape and reel specifications are available on www.onsemi.com.

FAN48611 — 2.5 MHz, Fixed-Output Synchronous Tiny Boost® Regulator

Block Diagram

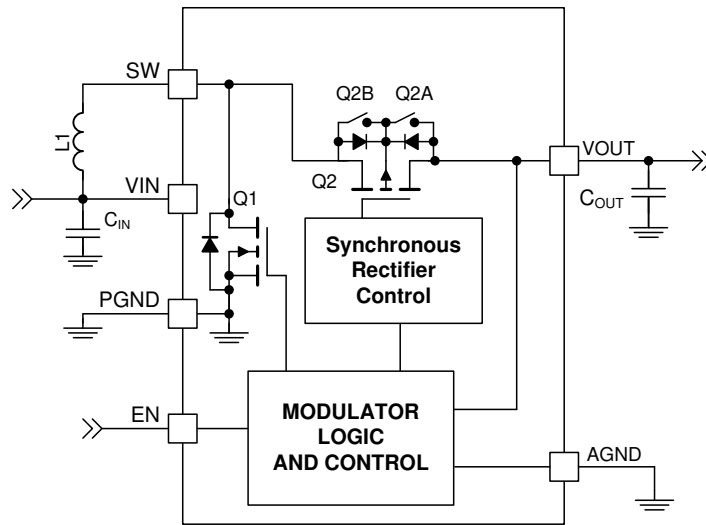

Figure 2. IC Block Diagram

Table 1. Recommended Components

Component	Description	Vendor	Parameter	Typ.	Unit
L1	2012, 1.9 A, 0.6 mm Max. Height	PIXC20120F1R0MDR	L	1	μH
			DCR (Series R)	175	mΩ
C _{IN}	20%, 6.3 V, X5R, 0402	C1005X5R0J106M050BC TDK	C	10	μF
C _{OUT}	20%, 6.3 V, X5R, 0402	C1005X5R0J106M050BC TDK	C	10	μF

Pin Configuration

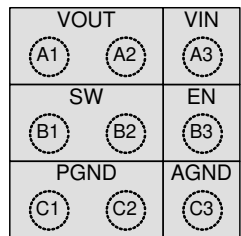

Figure 3. Top View

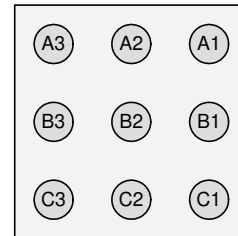

Figure 4. Bottom View

Pin Definitions

Pin #	Name	Description
A1, A2	VOUT	Output Voltage. This pin is the output voltage terminal; connect directly to C _{OUT} .
A3	VIN	Input Voltage. Connect to the Li-Ion battery input power source and the bias supply for the gate drivers.
B1, B2	SW	Switching Node. Connect to inductor.
B3	EN	Enable. When this pin is HIGH, the circuit is enabled. Connection to a logic voltage of 1.8 V and delivery voltage after UVLO typical voltage of 2.2 V is recommended.
C1, C2	PGND	Power Ground. This is the power return for the IC. C _{OUT} capacitor should be returned with the shortest path possible to these pins.
C3	AGND	Analog Ground. This is the signal ground reference for the IC. All voltage levels are measured with respect to this pin. Connect to PGND at a single point.

Absolute Maximum Ratings

Stresses exceeding the absolute maximum ratings may damage the device. The device may not function or be operable above the recommended operating conditions and stressing the parts to these levels is not recommended. In addition, extended exposure to stresses above the recommended operating conditions may affect device reliability. The absolute maximum ratings are stress ratings only.

Symbol	Parameter		Min.	Max.	Unit
V _{IN}	Voltage on VIN Pin		-0.3	6.0	V
V _{OUT}	Voltage on VOUT Pin			6.0	V
V _{SW}	Voltage on SW Node	DC	-0.3	6.0	V
		Transient: 10 ns, 3 MHz	-1.0	8.0	
V _{CC}	Voltage on Other Pins		-0.3	6.0 ⁽²⁾	V
ESD	Electrostatic Discharge Protection Level	Human Body Model, ANSI/ESDA/JEDEC JS-001-2012	2		kV
		Charged Device Model per JESD22-C101	2		
T _J	Junction Temperature		-40	+150	°C
T _{STG}	Storage Temperature		-65	+150	°C
T _L	Lead Soldering Temperature, 10 Seconds			+260	°C

Note:

2. Lesser of 6.0 V or V_{IN} + 0.3 V.

Recommended Operating Conditions

The Recommended Operating Conditions table defines the conditions for actual device operation. Recommended operating conditions are specified to ensure optimal performance to the datasheet specifications. ON Semiconductor does not recommend exceeding them or designing to absolute maximum ratings.

Symbol	Parameter	Min.	Max.	Unit
V _{IN}	Supply Voltage	2.7	4.8	V
I _{OUT}	Maximum Output Current	350		mA
T _A	Ambient Temperature	-40	+85	°C
T _J	Junction Temperature	-40	+125	°C

Thermal Properties

Junction-to-ambient thermal resistance is a function of application and board layout. This data is measured with four-layer 2s2p boards with vias in accordance to JEDEC standard JESD51. Special attention must be paid not to exceed junction temperature, T_{J(max)}, at a given ambient temperature, T_A.

Symbol	Parameter	Typical	Unit
θ _{JA}	Junction-to-Ambient Thermal Resistance	50	°C/W

Electrical Specifications

Recommended operating conditions, unless otherwise noted, circuit per Figure 1, $V_{OUT} = 5.25\text{ V}$, $V_{IN} = 2.7\text{ V}$ to 4.8 V , and $T_A = -40^\circ\text{C}$ to 85°C . Typical values are given $V_{IN} = 3.7\text{ V}$ and $T_A = 25^\circ\text{C}$.

Symbol	Parameter	Conditions	Min.	Typ.	Max.	Unit
Power Supply						
I_Q	V_{IN} Quiescent Current	$V_{IN}=3.7\text{ V}$, $I_{OUT}=0$, $EN=V_{IN}$		90	140	μA
		Shutdown: $EN=0$, $V_{IN}=3.7\text{ V}$, $V_{OUT}=0\text{ V}$		2.7	10.0	
V_{UVLO}	Under-Voltage Lockout	V_{IN} Rising		2.2	2.3	V
V_{UVLO_HYS}	Under-Voltage Lockout Hysteresis			150		mV
Inputs						
V_{IH}	Enable HIGH Voltage		1.2			V
V_{IL}	Enable LOW Voltage				0.4	V
I_{PD}	Current Sink Pull-Down	EN Pin, Logic HIGH		100		nA
R_{LOW}	Low-State Active Pull-Down	EN Pin, Logic LOW	200	300	400	k Ω
Outputs						
V_{REG}	Output Voltage Accuracy DC ⁽³⁾	Referred to V_{OUT}	-2		4	%
I_{LK_OUT}	V_{IN} -to- V_{OUT} Leakage Current	$V_{OUT}=0$, $EN=0$, $V_{IN}=2.7\text{ V}$			1	μA
I_{LK}	V_{OUT} -to- V_{IN} Reverse Leakage Current	$V_{OUT}=5.3\text{ V}$, $EN=0$, $V_{IN}=2.7\text{ V}$			3.5	μA
V_{RIPPLE}	Output Ripple ⁽⁴⁾	0 mA to 300 mA		30		mV
V_{TRLOAD}	Load Transient ⁽⁴⁾	$I_{LOAD}=0\text{ mA} \leftrightarrow 120\text{ mA}$, $t_R=t_F=1\ \mu\text{s}$		± 30		mV
		$I_{LOAD}=0\text{ mA} \leftrightarrow 285\text{ mA}$, $t_R=t_F=8\ \mu\text{s}$		± 90		
V_{TRLINE}	Line Transient ⁽⁴⁾	$V_{IN}=3.2\text{ V} \leftrightarrow 3.9\text{ V}$, $I_{LOAD}=120\text{ mA}$ $t_R=t_F=7\ \mu\text{s}$		± 50		mV
η	Efficiency ⁽⁴⁾	$V_{IN}=3\text{ V}$, $I_{LOAD}=5\text{ mA}$		85		%
		$V_{IN}=3\text{ V}$, $I_{LOAD}=200\text{ mA}$		90		
		$V_{IN}=3.6\text{ V}$, $I_{LOAD}=200\text{ mA}$		91		
		$V_{IN}=3.6\text{ V}$, $I_{LOAD}=300\text{ mA}$		92		
Timing						
f_{SW}	Switching Frequency	$V_{IN}=3.6\text{ V}$, $V_{OUT}=5.25\text{ V}$, $I_{LOAD}=300\text{ mA}$	2.0	2.5	3.0	MHz
t_{SS}	Soft-Start EN HIGH to Regulation ⁽⁴⁾	$V_{IN}=3.0\text{ V}$, $V_{OUT}=5.25\text{ V}$, $I_{LOAD}=0\text{ mA}$, $C_{OUT}=3 \times 10\ \mu\text{F}$		1000		μs
I_{SS}	Input Peak Current			90	200	mA
t_{RST}	FAULT Restart Timer ⁽⁴⁾			20		ms
Power Stage						
$R_{DS(ON)N}$	N-Channel Boost Switch $R_{DS(ON)}$	$V_{IN}=3.6\text{ V}$, $V_{OUT}=5.25\text{ V}$		80	130	m Ω
$R_{DS(ON)P}$	P-Channel Sync. Rectifier $R_{DS(ON)}$	$V_{IN}=3.6\text{ V}$, $V_{OUT}=5.25\text{ V}$		65	115	m Ω
I_{V_LIM}	Boost Valley Current Limit	$V_{OUT}=5.25\text{ V}$		750		mA
$I_{V_LIM_SS}$	Boost Soft-Start Valley Current Limit	$V_{IN} < V_{OUT} < V_{OUT_TARGET}$		375		A
T_{150T}	Over-Temperature Protection (OTP)			150		$^\circ\text{C}$
T_{150H}	OTP Hysteresis			20		$^\circ\text{C}$

Notes:

- DC I_{LOAD} from 0 to 0.35 A. V_{OUT} measured from mid-point of output voltage ripple. Effective capacitance of $C_{OUT} \geq 6\ \mu\text{F}$.
- Guaranteed by design and characterization; not tested in production.

Typical Performance Characteristics

Unless otherwise specified; $V_{IN} = 3.6\text{ V}$, $V_{OUT} = 5.25\text{ V}$, $T_A = 25^\circ\text{C}$, and circuit and components according to Figure 1.

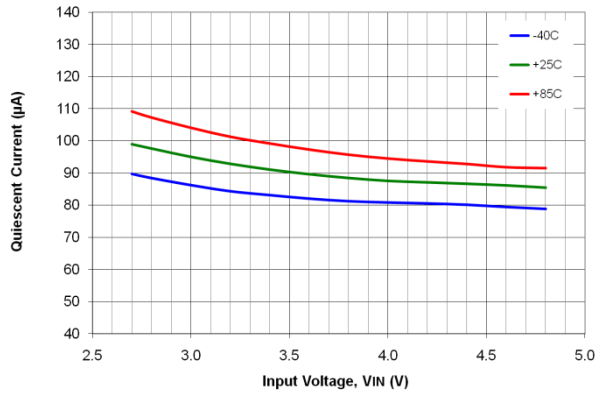

Figure 5. Quiescent Current vs. Input Voltage and Temperature

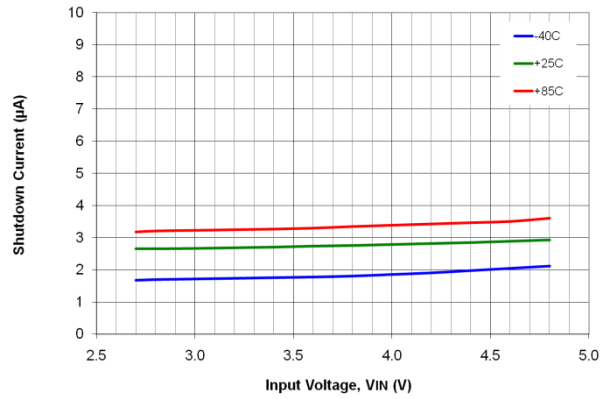

Figure 6. Shutdown Current vs. Load Current and Temperature

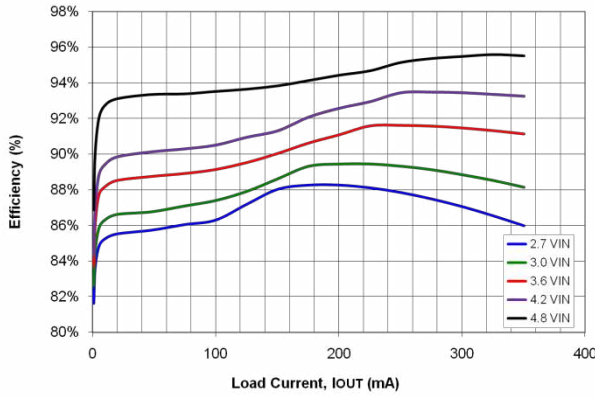

Figure 7. Efficiency vs. Load Current and Input Voltage

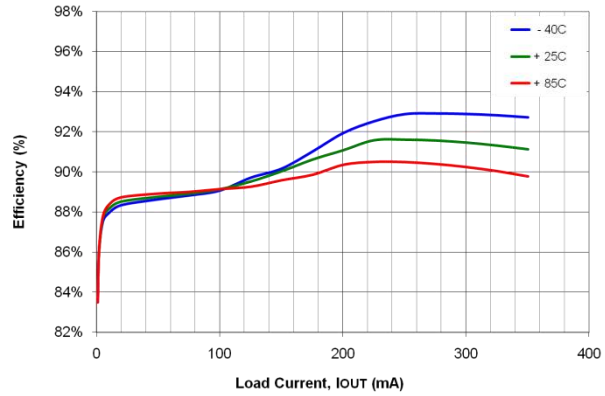

Figure 8. Efficiency vs. Load Current and Temperature

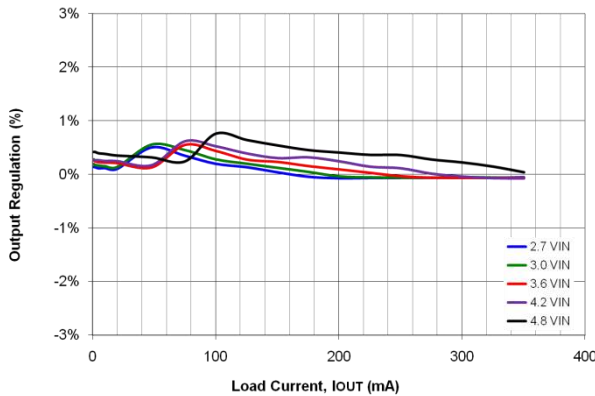

Figure 9. Output Regulation vs. Load Current and Input Voltage

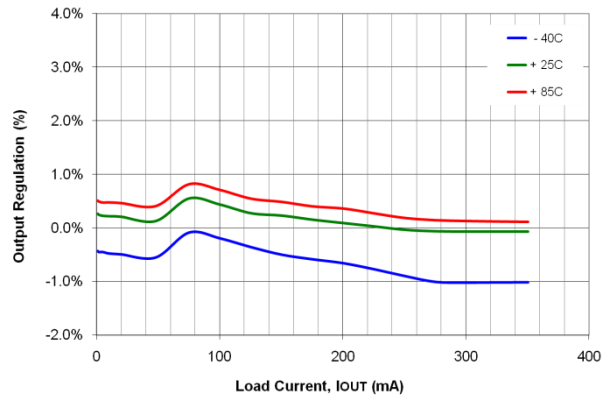

Figure 10. Output Regulation vs. Load Current and Temperature

Typical Performance Characteristics

Unless otherwise specified; $V_{IN} = 3.6\text{ V}$, $V_{OUT} = 5.25\text{ V}$, $T_A = 25^\circ\text{C}$, and circuit and components according to Figure 1

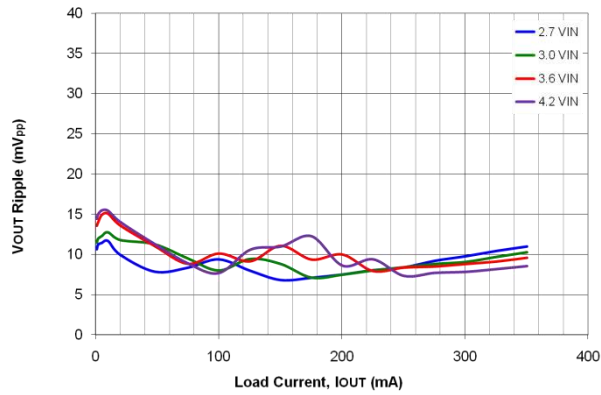

Figure 11. Output Ripple vs. Load Current and Input Voltage

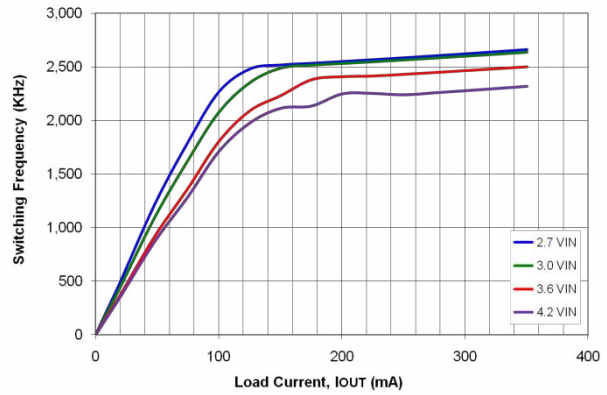

Figure 12. Switching Frequency vs. Load Current and Temperature

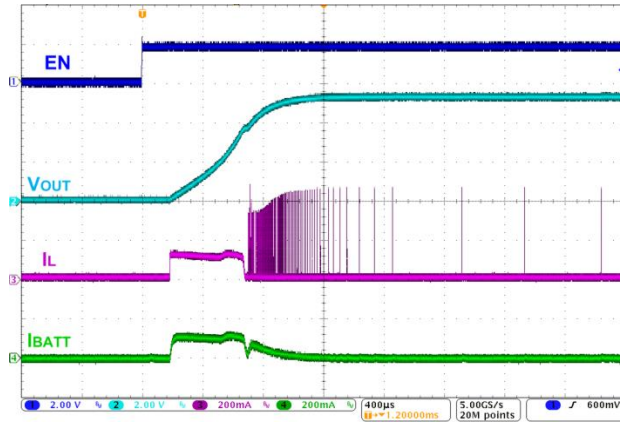

Figure 13. Startup, No Load

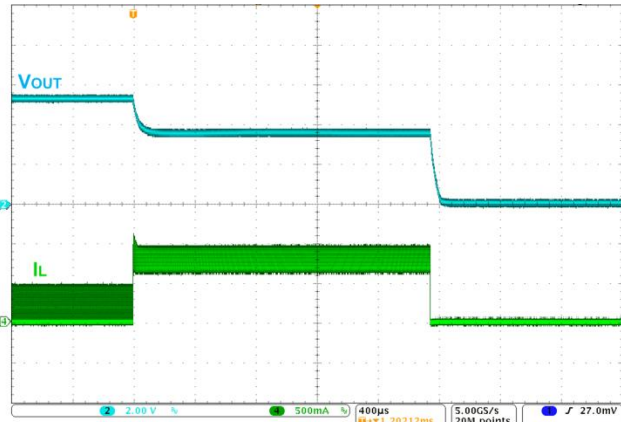

Figure 14. Overload Protection

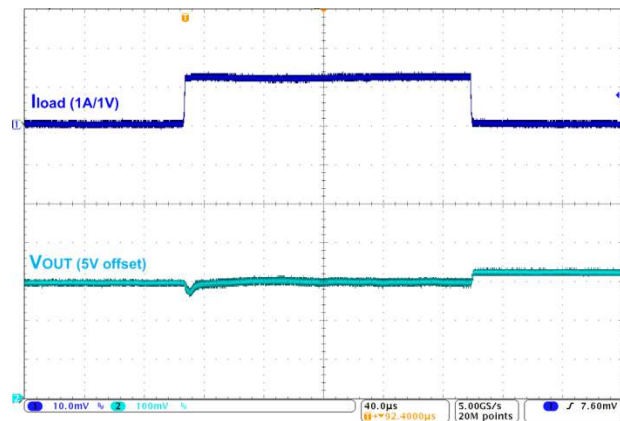

Figure 15. Load Transient, 0 <-> 120 mA, 1 μs Edge

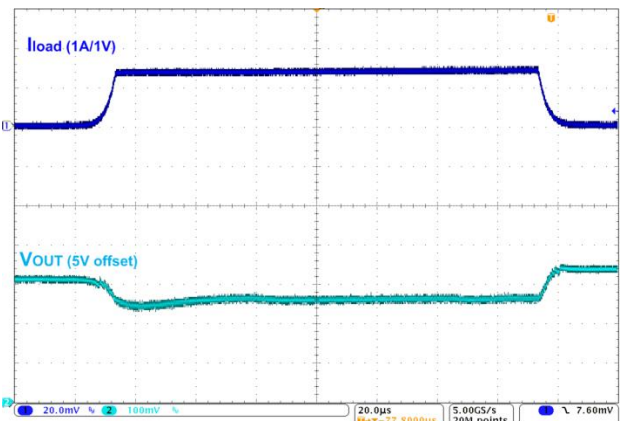

Figure 16. Load Transient, 0 <-> 285 mA, 8 μs Edge

Typical Characteristics

Unless otherwise specified; $V_{IN}=3.6\text{ V}$, $V_{OUT}=5.25\text{ V}$, $T_A=25^\circ\text{C}$, and circuit and components according to Figure 1

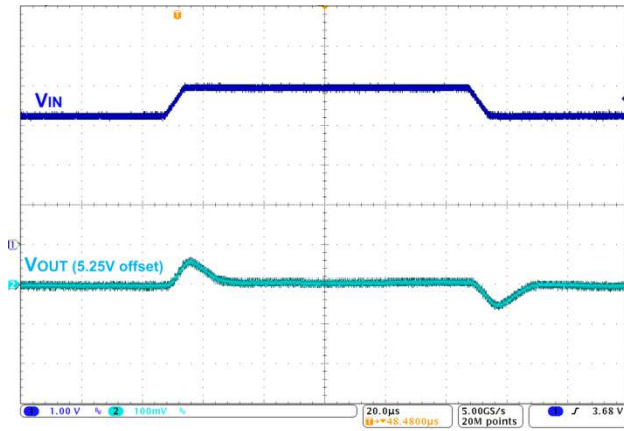

Figure 17. Line Transient, 3.2 <--> 3.9 V_{IN} , 7 μs Edge, 120 mA Load

Functional Description

FAN48611 is a synchronous boost regulator, typically operating at 2.5 MHz in Continuous Conduction Mode (CCM), which occurs at moderate to heavy load current and low V_{IN} voltage.

Table 2. Operating Modes

Mode	Description	Invoked When:
LIN	Linear Startup	$V_{IN} > V_{OUT}$
SS	Boost Soft-Start	$V_{IN} < V_{OUT} < V_{OUT(TARGET)}$
BST	Boost Mode	$V_{OUT} = V_{OUT(TARGET)}$

Boost Mode Regulation

The current-mode modulator achieves excellent transient response and smooth transitions between CCM and DCM operation. During CCM operation, the device maintains a switching frequency of about 2.5 MHz. In light-load operation (DCM), frequency is naturally reduced to maintain high efficiency.

Startup and Shutdown

When EN is LOW, all bias circuits are off and the regulator enters Shutdown Mode. During shutdown, current flow is prevented from V_{IN} to V_{OUT} , as well as reverse flow from V_{OUT} to V_{IN} . It is recommended to keep load current draw below 50 mA until the device successfully executes startup. Table 3 describes the startup sequence.

Table 3. Boost Startup Sequence

Start Mode	Entry	Exit	End Mode	Timeout (μs)
LIN1	$V_{IN} > V_{UVLO}$, EN=1	$V_{OUT} > V_{IN} - 300$ mV	SS	
		TIMEOUT	LIN2	512
LIN2	LIN1 Exit	$V_{OUT} > V_{IN} - 300$ mV	SS	
		TIMEOUT	FAULT	1024
SS	LIN1 or LIN2 Exit	$V_{OUT} = V_{OUT(TARGET)}$	BST	
		OVERLOAD TIMEOUT	FAULT	64

LIN Mode

When EN is HIGH and $V_{IN} > V_{UVLO}$, the regulator attempts to bring V_{OUT} within 300 mV of V_{IN} using the internal fixed-current source from V_{IN} (Q2). The current is limited to the I_{SS} set point, which is typically 90 mA. The linear charging current is limited to a maximum of 200 mA to prevent any “brownout” situations where the system voltage drops too low.

During LIN1 Mode, if V_{OUT} reaches $V_{IN} - 300$ mV, SS Mode is initiated. Otherwise, LIN1 Mode expires after 512 μs and LIN2 Mode is entered.

In LIN2 Mode, the current source is equal to LIN1 current source I_{SS} , typically 90 mA. If V_{OUT} fails to reach $V_{IN} - 300$ mV after 1024 μs, a fault condition is declared and the device waits 20 ms (t_{RST}) to attempt an automatic restart.

Soft-Start (SS) Mode

Upon the successful completion of LIN Mode ($V_{OUT} \geq V_{IN} - 300$ mV), the regulator begins switching with boost pulses current limited to 50% of nominal level.

During SS Mode, if V_{OUT} fails to reach regulation during the SS ramp sequence for more than 64 μs, a fault is declared. If a large C_{OUT} is used, the reference is automatically stepped slower to avoid excessive input current draw.

Boost (BST) Mode

This is a normal operating mode of the regulator.

Fault State

The regulator enters Fault State under any of the following conditions:

- V_{OUT} fails to achieve the voltage required to advance from LIN Mode to SS Mode.
- V_{OUT} fails to achieve the voltage required to advance from SS Mode to BST Mode.
- Boost current limit triggers for 2 ms during BST Mode.
- $V_{IN} - V_{OUT} > 300$ mV; this fault can occur only after successful completion of the soft-start sequence.
- $V_{IN} < V_{UVLO}$.

Once a fault is triggered, the regulator stops switching and presents a high-impedance path between V_{IN} and V_{OUT} . After 20 ms, automatic restart is attempted.

Over-Temperature

The regulator shuts down if the die temperature exceeds 150°C. Restart occurs when the IC has cooled by approximately 20°C.

Application Information

Output Capacitance (C_{OUT})

The effective capacitance (C_{EFF}⁽⁵⁾) of small, high-value ceramic capacitors decreases as the bias voltage increases, as illustrated in Figure 18.

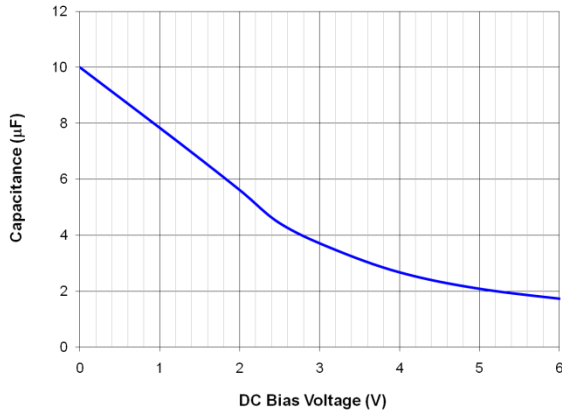

Figure 18. C_{EFF} for 10 µF, 0402, X5R, 6.3 V-Rated Capacitor (TDK C1005X5R0J106M050BC)

FAN48611 is guaranteed for stable operation with the minimum value of C_{EFF} (C_{EFF(MIN)}) outlined in Table 4

Table 4. Minimum C_{EFF} Required for Stability

Operating Conditions			C _{EFF(MIN)} (µF)
V _{OUT} (V)	V _{IN} (V)	I _{LOAD} (mA)	
5.25	2.7 to 4.8	0 to 350	6.0

Note:

- C_{EFF} varies by manufacturer, capacitor material, and case size.

Inductor Selection

Recommended nominal inductance value is 1 µH.

The FAN48611 employs valley-current limiting, so peak inductor current can reach 1.2 A for a short duration during overload conditions. Saturation causes the inductor current ripple to increase under high loading, as only the valley of the inductor current ripple is controlled.

Startup

Input current limiting is active during soft-start, which limits the current available to charge C_{OUT} and any additional capacitance on the V_{OUT} line. If the output fails to achieve regulation within the limits described in the Soft-Start section above, a fault occurs, causing the circuit to shut down. It waits about 20 ms before attempting a restart. If the total combined output capacitance is very high, the circuit may not start on the first attempt, but eventually achieves regulation if no load is present. If a high current load and high capacitance are both present during soft-start, the circuit may fail to achieve regulation and continually attempt

soft-start, only to have the output capacitance discharged by the load when in Fault State.

Output Voltage Ripple

Output voltage ripple is inversely proportional to C_{OUT}. During t_{ON}, when the boost switch is on, all load current is supplied by C_{OUT}.

$$V_{RIPPLE(P-P)} = t_{ON} \cdot \frac{I_{LOAD}}{C_{OUT}} \quad (1)$$

and

$$t_{ON} = t_{SW} \cdot D = t_{SW} \cdot \left(1 - \frac{V_{IN}}{V_{OUT}}\right) \quad (2)$$

therefore:

$$V_{RIPPLE(P-P)} = t_{SW} \cdot \left(1 - \frac{V_{IN}}{V_{OUT}}\right) \cdot \frac{I_{LOAD}}{C_{OUT}} \quad (3)$$

$$t_{SW} = \frac{1}{f_{SW}} \quad (4)$$

The maximum V_{RIPPLE} occurs when V_{IN} is minimum and I_{LOAD} is maximum. For better ripple performance, more output capacitance can be added.

Layout Recommendations

The layout recommendations below highlight various top-copper pours by using different colors.

To minimize spikes at V_{OUT}, C_{OUT} must be placed as close as possible to PGND and V_{OUT}, as shown below.

For best thermal performance, maximize the pour area for all planes other than SW. The ground pour, especially, should fill all available PCB surface area and be tied to internal layers with a cluster of thermal vias.

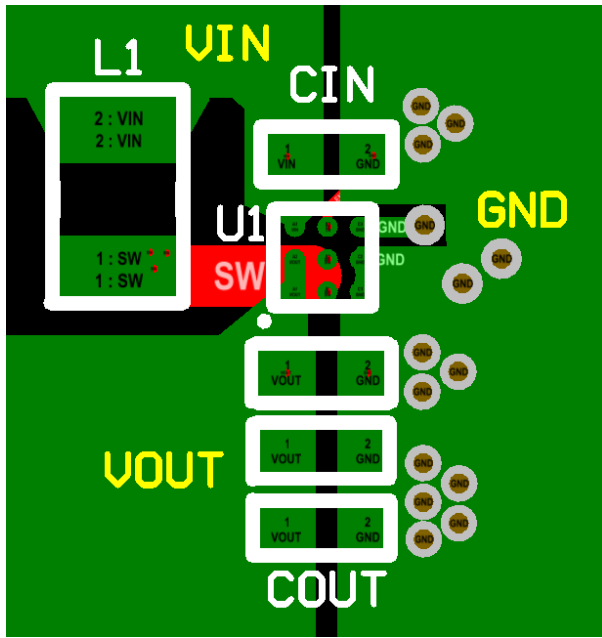

Figure 19. Layout Recommendation

The table below pertains to the Package information on the following page.

Table 5. Product-Specific Dimensions

D	E	X	Y
1.215 ±0.030 mm	1.215 ±0.030 mm	0.2075 mm	0.2075 mm

Physical Dimensions

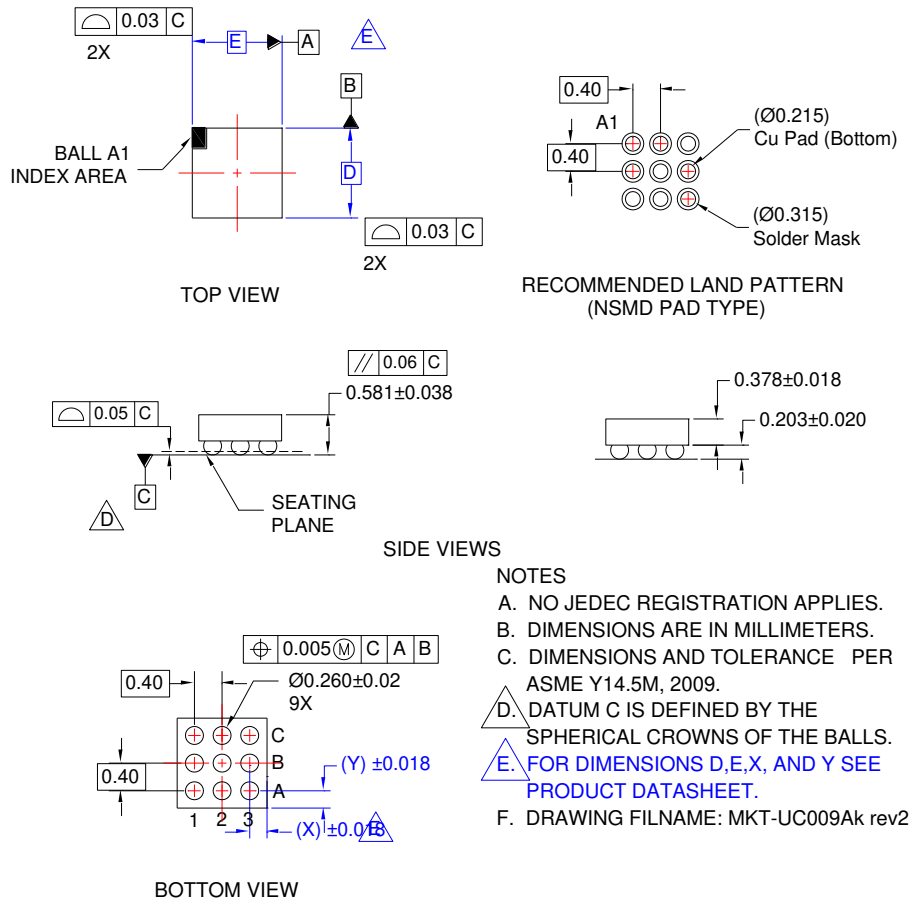

Figure 20. 9-Bump, 0.4 mm Pitch, Wafer-Level Chip-Scale Package (WLCSP)

ON Semiconductor and the ON Semiconductor logo are trademarks of Semiconductor Components Industries, LLC dba ON Semiconductor or its subsidiaries in the United States and/or other countries. ON Semiconductor owns the rights to a number of patents, trademarks, copyrights, trade secrets, and other intellectual property. A listing of ON Semiconductor's product/patent coverage may be accessed at www.onsemi.com/site/pdf/Patent-Marking.pdf. ON Semiconductor reserves the right to make changes without further notice to any products herein. ON Semiconductor makes no warranty, representation or guarantee regarding the suitability of its products for any particular purpose, nor does ON Semiconductor assume any liability arising out of the application or use of any product or circuit, and specifically disclaims any and all liability, including without limitation special, consequential or incidental damages. Buyer is responsible for its products and applications using ON Semiconductor products, including compliance with all laws, regulations and safety requirements or standards, regardless of any support or applications information provided by ON Semiconductor. "Typical" parameters which may be provided in ON Semiconductor data sheets and/or specifications can and do vary in different applications and actual performance may vary over time. All operating parameters, including "Typicals" must be validated for each customer application by customer's technical experts. ON Semiconductor does not convey any license under its patent rights nor the rights of others. ON Semiconductor products are not designed, intended, or authorized for use as a critical component in life support systems or any FDA Class 3 medical devices or medical devices with a same or similar classification in a foreign jurisdiction or any devices intended for implantation in the human body. Should Buyer purchase or use ON Semiconductor products for any such unintended or unauthorized application, Buyer shall indemnify and hold ON Semiconductor and its officers, employees, subsidiaries, affiliates, and distributors harmless against all claims, costs, damages, and expenses, and reasonable attorney fees arising out of, directly or indirectly, any claim of personal injury or death associated with such unintended or unauthorized use, even if such claim alleges that ON Semiconductor was negligent regarding the design or manufacture of the part. ON Semiconductor is an Equal Opportunity/Affirmative Action Employer. This literature is subject to all applicable copyright laws and is not for resale in any manner.

PUBLICATION ORDERING INFORMATION

LITERATURE FULFILLMENT:

Literature Distribution Center for ON Semiconductor
 19521 E. 32nd Pkwy, Aurora, Colorado 80011 USA
Phone: 303-675-2175 or 800-344-3860 Toll Free USA/Canada
Fax: 303-675-2176 or 800-344-3867 Toll Free USA/Canada
Email: orderlit@onsemi.com

N. American Technical Support: 800-282-9855 Toll Free
 USA/Canada.

Europe, Middle East and Africa Technical Support:
 Phone: 421 33 790 2910

Japan Customer Focus Center
 Phone: 81-3-5817-1050

ON Semiconductor Website: www.onsemi.com

Order Literature: <http://www.onsemi.com/orderlit>

For additional information, please contact your local
 Sales Representative

ON Semiconductor and  are trademarks of Semiconductor Components Industries, LLC dba ON Semiconductor or its subsidiaries in the United States and/or other countries. ON Semiconductor owns the rights to a number of patents, trademarks, copyrights, trade secrets, and other intellectual property. A listing of ON Semiconductor's product/patent coverage may be accessed at www.onsemi.com/site/pdf/Patent-Marking.pdf. ON Semiconductor reserves the right to make changes without further notice to any products herein. ON Semiconductor makes no warranty, representation or guarantee regarding the suitability of its products for any particular purpose, nor does ON Semiconductor assume any liability arising out of the application or use of any product or circuit, and specifically disclaims any and all liability, including without limitation special, consequential or incidental damages. Buyer is responsible for its products and applications using ON Semiconductor products, including compliance with all laws, regulations and safety requirements or standards, regardless of any support or applications information provided by ON Semiconductor. "Typical" parameters which may be provided in ON Semiconductor data sheets and/or specifications can and do vary in different applications and actual performance may vary over time. All operating parameters, including "Typicals" must be validated for each customer application by customer's technical experts. ON Semiconductor does not convey any license under its patent rights nor the rights of others. ON Semiconductor products are not designed, intended, or authorized for use as a critical component in life support systems or any FDA Class 3 medical devices or medical devices with a same or similar classification in a foreign jurisdiction or any devices intended for implantation in the human body. Should Buyer purchase or use ON Semiconductor products for any such unintended or unauthorized application, Buyer shall indemnify and hold ON Semiconductor and its officers, employees, subsidiaries, affiliates, and distributors harmless against all claims, costs, damages, and expenses, and reasonable attorney fees arising out of, directly or indirectly, any claim of personal injury or death associated with such unintended or unauthorized use, even if such claim alleges that ON Semiconductor was negligent regarding the design or manufacture of the part. ON Semiconductor is an Equal Opportunity/Affirmative Action Employer. This literature is subject to all applicable copyright laws and is not for resale in any manner.

PUBLICATION ORDERING INFORMATION

LITERATURE FULFILLMENT:

Literature Distribution Center for ON Semiconductor
19521 E. 32nd Pkwy, Aurora, Colorado 80011 USA
Phone: 303-675-2175 or 800-344-3860 Toll Free USA/Canada
Fax: 303-675-2176 or 800-344-3867 Toll Free USA/Canada
Email: orderlit@onsemi.com

N. American Technical Support: 800-282-9855 Toll Free
USA/Canada
Europe, Middle East and Africa Technical Support:
Phone: 421 33 790 2910
Japan Customer Focus Center
Phone: 81-3-5817-1050

ON Semiconductor Website: www.onsemi.com
Order Literature: <http://www.onsemi.com/orderlit>
For additional information, please contact your local
Sales Representative