



TDA7480

10W MONO CLASS-D AMPLIFIER

- 10W OUTPUT POWER:
 $R_L = 8\Omega/4\Omega$; THD = 10%
- HIGH EFFICIENCY
- NO HEATSINK
- SPLIT SUPPLY
- OVERVOLTAGE PROTECTION
- ST-BY AND MUTE FEATURES
- SHORT CIRCUIT PROTECTION
- THERMAL OVERLOAD PROTECTION

DESCRIPTION

The TDA7480 is an audio class-D amplifier assembled in Power DIP package specially designed for high efficiency applications mainly for TV and Home Stereo sets.

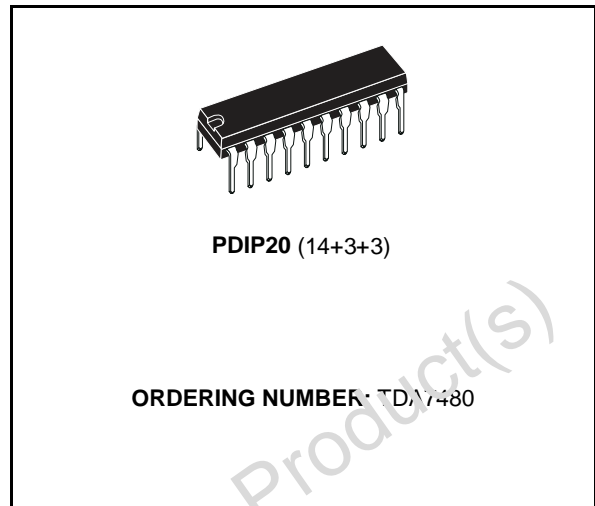
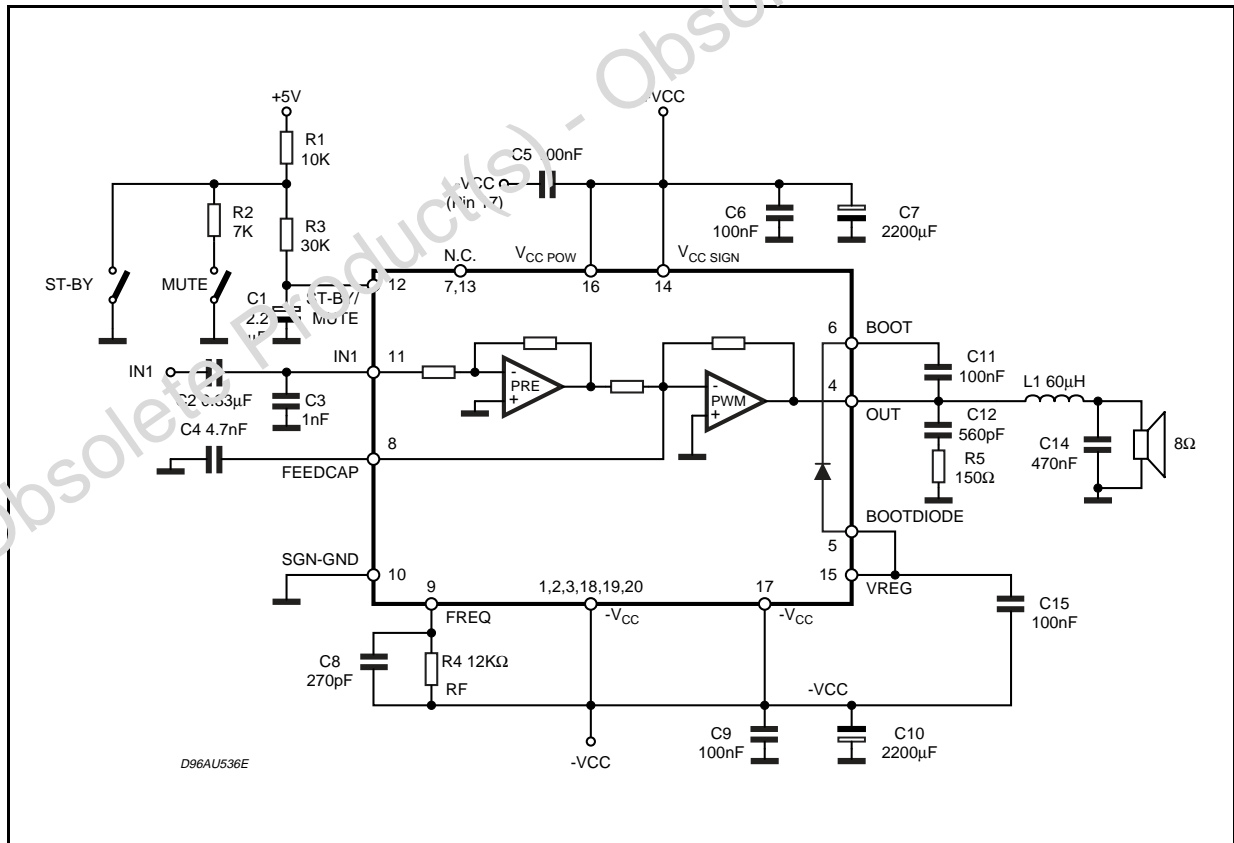

Figure 1: Test and Application Circuit.



ABSOLUTE MAXIMUM RATINGS

Symbol	Parameter	Value	Unit
V _{CC}	DC Supply Voltage	±20	V
T _{stg} , T _j	Storage and Junction Temperature	-40 to 150	°C
V _{FREQ}	Maximum Voltage Across VFREQ (Pin 9)	8	V
T _{op}	Operating Temperature Range	-20 to 70	°C
ESD	Maximum ESD on Pins	±1.8	kV

PIN CONNECTION (Top view)

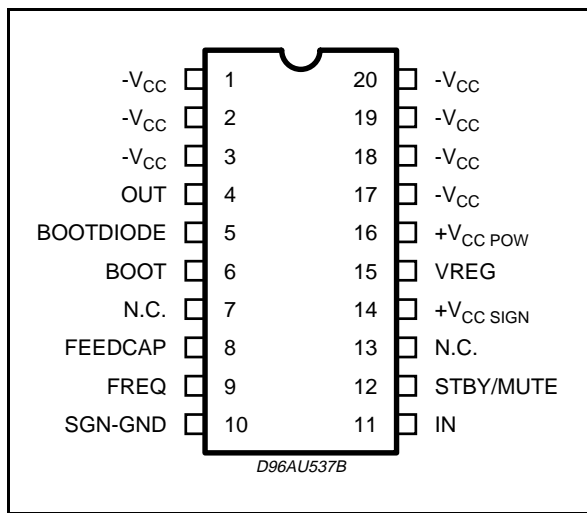

R_{th} with "on board" Square Heatsink vs. copper area.

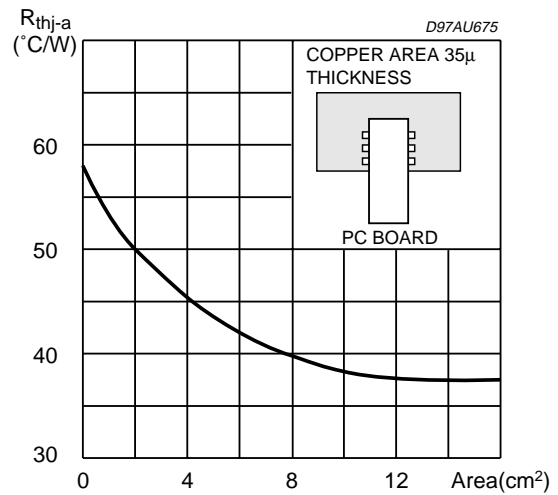

THERMAL DATA

Symbol	Parameter	Value	Unit
R _{th j-amb}	Thermal Resistance Junction to ambient	80	°C/W
R _{th j-pin}	Thermal Resistance Junction to Pin	Max. 12	°C/W

PIN FUNCTIONS

N.	Name	Function
1	-V _{CC}	NEGATIVE SUPPLY.
2	-V _{CC}	NEGATIVE SUPPLY.
3	-V _{CC}	NEGATIVE SUPPLY.
4	OUT	PWM OUTPUT
5	BOOTDIODE	BOOTSTRAP DIODE ANODE
6	BOOT	BOOTSTRAP CAPACITOR
7	NC	NOT CONNECTED
8	FEEDCAP	FEEDBACK INTEGRATING CAPACITANCE
9	FREQUENCY	SETTING FREQUENCY RESISTOR
10	SGN-GND	SIGNAL GROUND
11	IN	INPUT
12	ST-BY-MUTE	ST-BY/ MUTE CONTROL PIN
13	NC	NOT CONNECTED
14	+V _{CC} SIGN	POSITIVE SIGNAL SUPPLY
15	VREG	10V INTERNAL REGULATOR
16	+V _{CC} POW	POSITIVE POWER SUPPLY
17	-V _{CC}	NEGATIVE SUPPLY (TO BE CONNECTED TO PIN 16 VIA C5)
18	-V _{CC}	NEGATIVE SUPPLY
19	-V _{CC}	NEGATIVE SUPPLY
20	-V _{CC}	NEGATIVE SUPPLY

ELECTRICAL CHARACTERISTICS (Refer to the test circuit, $V_{CC} = \pm 14V$; $R_L = 8\Omega$; $R_S = 50\Omega$; $R_f = 12K\Omega$; Demod.. filter $L = 60\mu H$, $C = 470nF$; $f = 1KHz$; $T_{amb} = 25^\circ C$ unless otherwise specified.)

Symbol	Parameter	Test Condition	Min.	Typ.	Max.	Unit
V_S	Supply Range		± 10		± 16	V
I_q	Total Quiescent Current	$R_L = \infty$; NO LC Filter		25	40	mA
V_{OS}	Output Offset Voltage	Play Condition	-50		+50	mV
P_O	Output Power	THD = 10% THD = 1%	8.5 6	10 7		W W
		$R_L = 4\Omega$ $V_{CC} = \pm 10.5V$ THD = 10% THD = 1%		10 7		W W
P_d (*)	Dissipated Power at 1W Output Power	$R_f = 12K\Omega$ $P_O = 1W$		1		W
P_{DMAX}	Maximum Dissipated Power	$P_O = 10W$ THD 10% $R_{th-j-amb} = 38^\circ C/W$ (Area $12cm^2$)		1.8		W
η	Efficiency $\equiv \frac{P_O}{P_O + P_D} \equiv \frac{P_O}{P_I}$ (**)	THD 10% $R_{th-j-amb} = 38^\circ C/W$ (Area $12cm^2$)	80	85		%
THD	Total Harmonic Distortion	$R_L = 8\Omega$; $P_O = 0.5W$		0.1		%
I_{max}	Overcurrent Protection Threshold	$R_L = 0$	3.5	5		A
T_j	Thermal Shut-down Junction Temperature			150		$^\circ C$
G_V	Closed Loop Gain		29	30	31	dB
e_N	Total Input Noise	A Curve $f = 20Hz$ to $22KHz$		7 12		μV μV
R_i	Input Resistance		20	30		$K\Omega$
SVR	Supply Voltage Rejection	$f = 100Hz$; $V_r = 0.5$	46	60		dB
T_r, T_f	Rising and Falling Time			50		ns
R_{DSON}	Power Transistor on Resistance			0.4		Ω
F_{SW}	Switching Frequency		100	120	140	KHz
F_{SW_OP}	Switching Frequency Operative Range		100		200	KHz
B_F	Zero Signal Frequency Constant (***)			1.4×10^9		Hz Ω
R_F	Frequency Controller Resistor Range (****)		7	12	14	$K\Omega$
MUTE & STAND-BY FUNCTIONS						
V_{ST-BY}	Stand-by range				0.8	V
V_{MUTE}	Mute Range		1.8		2.5	V
V_{PLAY}	Play Range (1)		4			V
A_{MUTE}	Mute Attenuation		60	80		dB
I_{qST-BY}	Quiescent Current @ Stand-by			3	5	mA

*: The output average power when the amplifier is playing music can be considered roughly 1/10 of the maximum output power. So it is useful to consider the dissipated power in this condition for thermal dimensioning.

**: P_O = measured across the load using the following inductor:
COIL 58120 MPPA2 (magnetics) TURNS: 28 \varnothing 1mm
COIL77120 KOOL M μ (magnetics) TURNS: 28 \varnothing 1mm

***: The zero-signal switching frequency can be obtained using the following expression: $F_{SW} = B_F/R_F$

****: The maximum value of R_F is related to the maximum possible value for the voltage drop on R_F itself.

(1): For $V_{12} > 5.2V$, an input impedance of $10K\Omega$ is to be considered.

TDA7480

Figure 2: Recommended P.C. Board and Component Layout of the Circuit of Figure1 (1.25:1 scale).

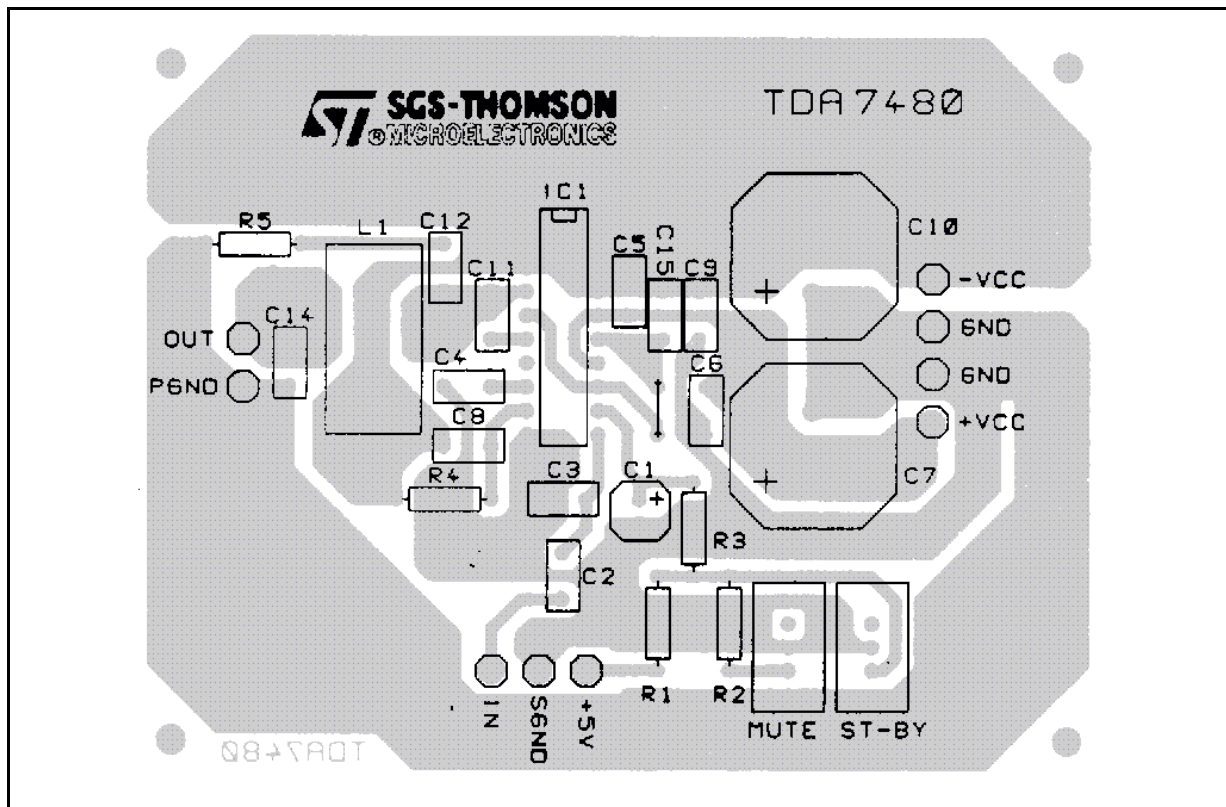

Note: Capacitor C5 must be as close as possible to device's pins 16 and 17

Figure 3: Stereo Application in Single Supply.

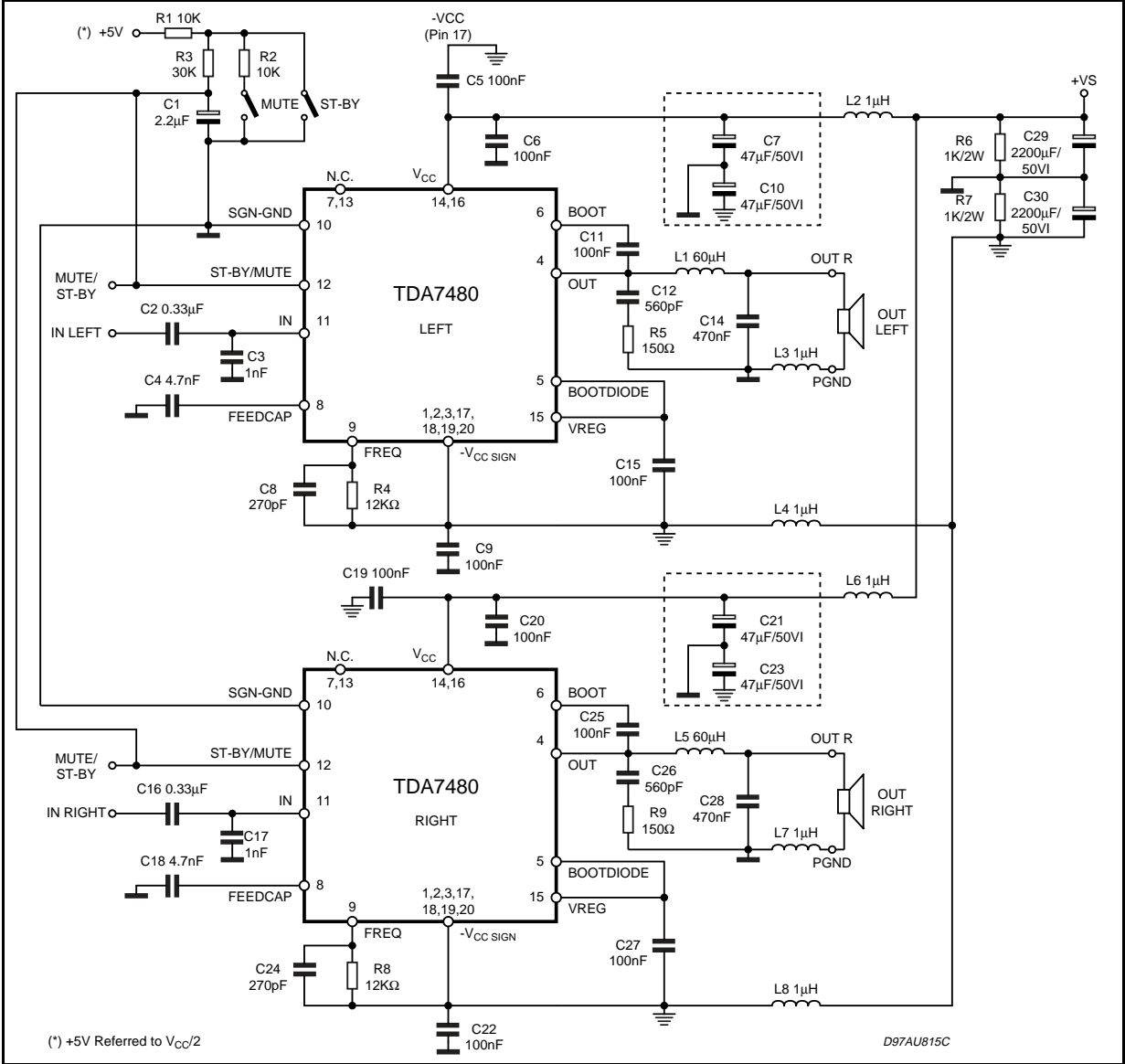
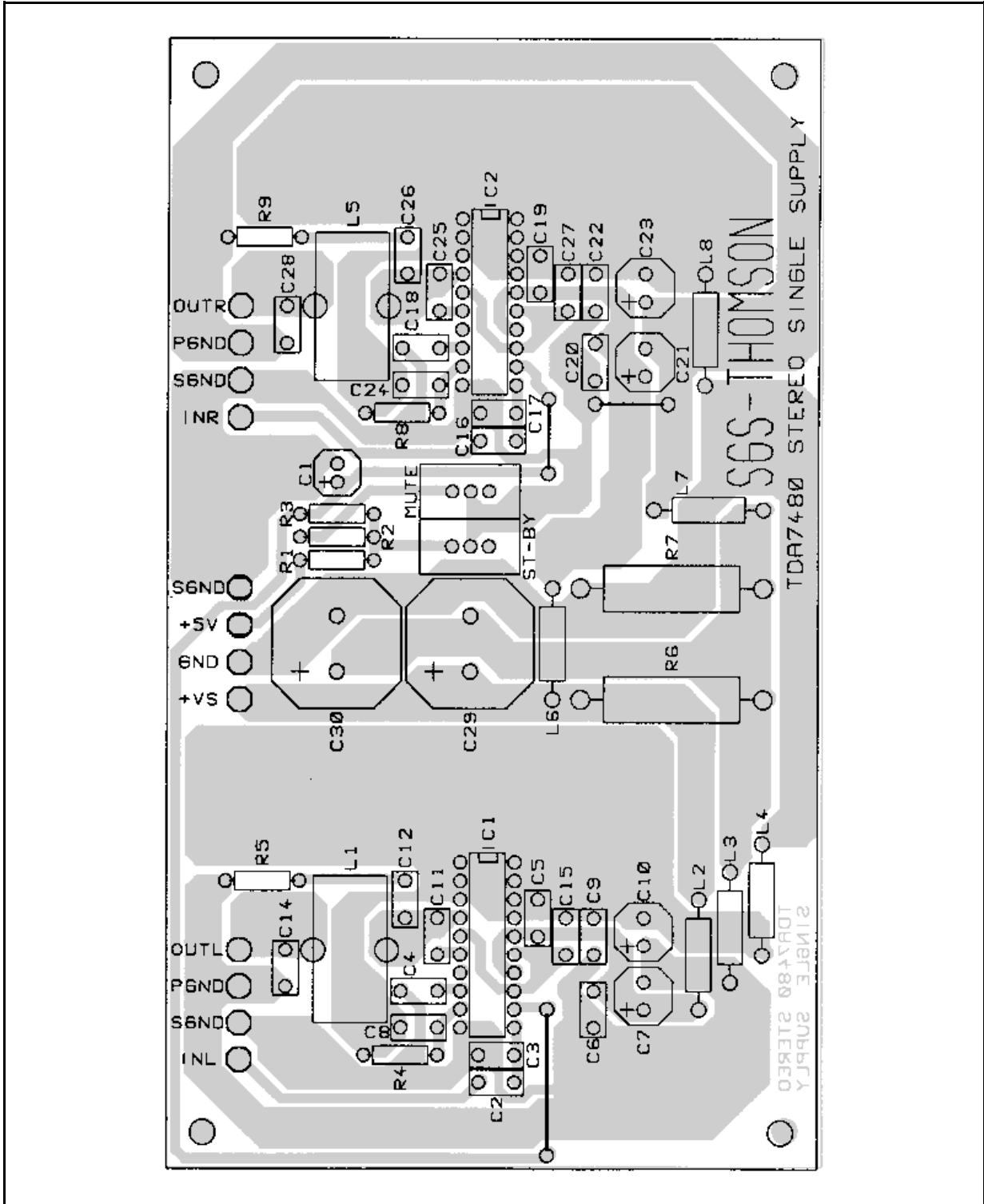

Figure 4: PC Board and component Layout of the Circuit of Figure 3.



TYPICAL CHARACTERISTICS (Application Circuit of fig 1 unless otherwise specified)

Figure 5. Output Power vs. Supply Voltage

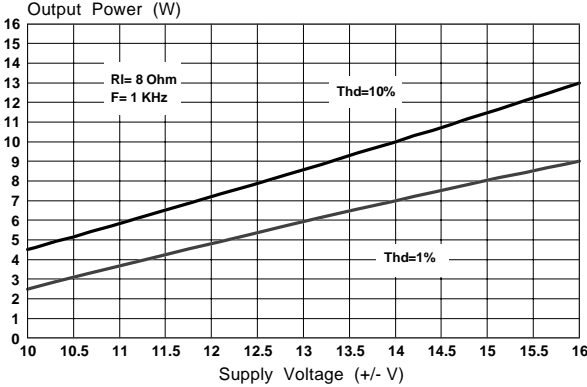

Figure 6. Distortion vs. Output Power

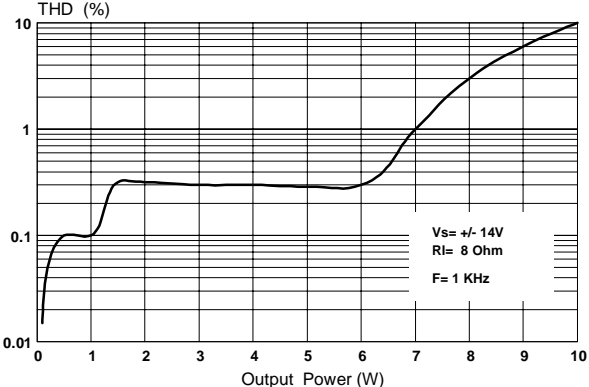

Figure 7. Distortion vs. Output Power

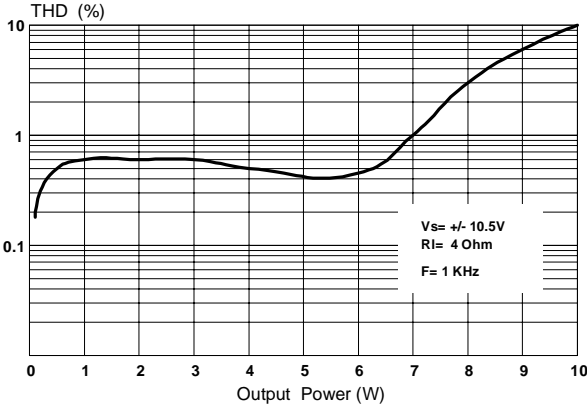

Figure 8. Power Dissipation and Efficiency vs. Output Power

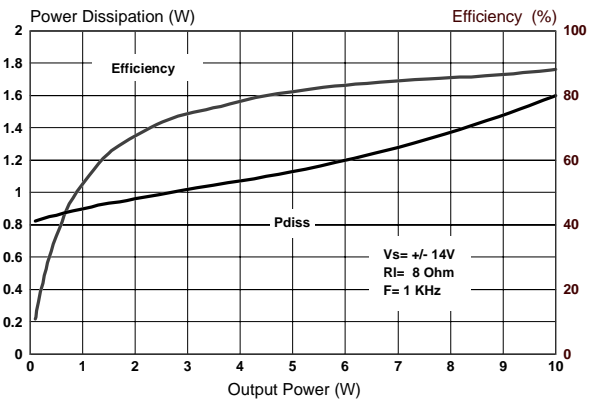

Figure 9. Power Dissipation and Efficiency vs. Output Power

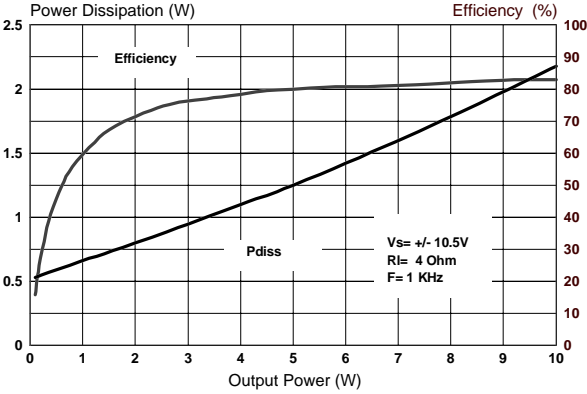

Figure 10. Mute Attenuation vs. Vpin 12

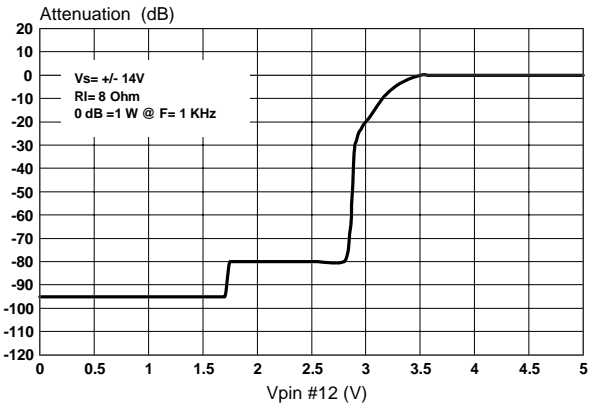
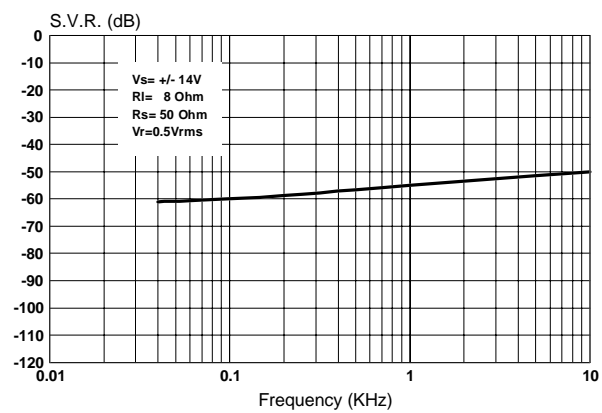
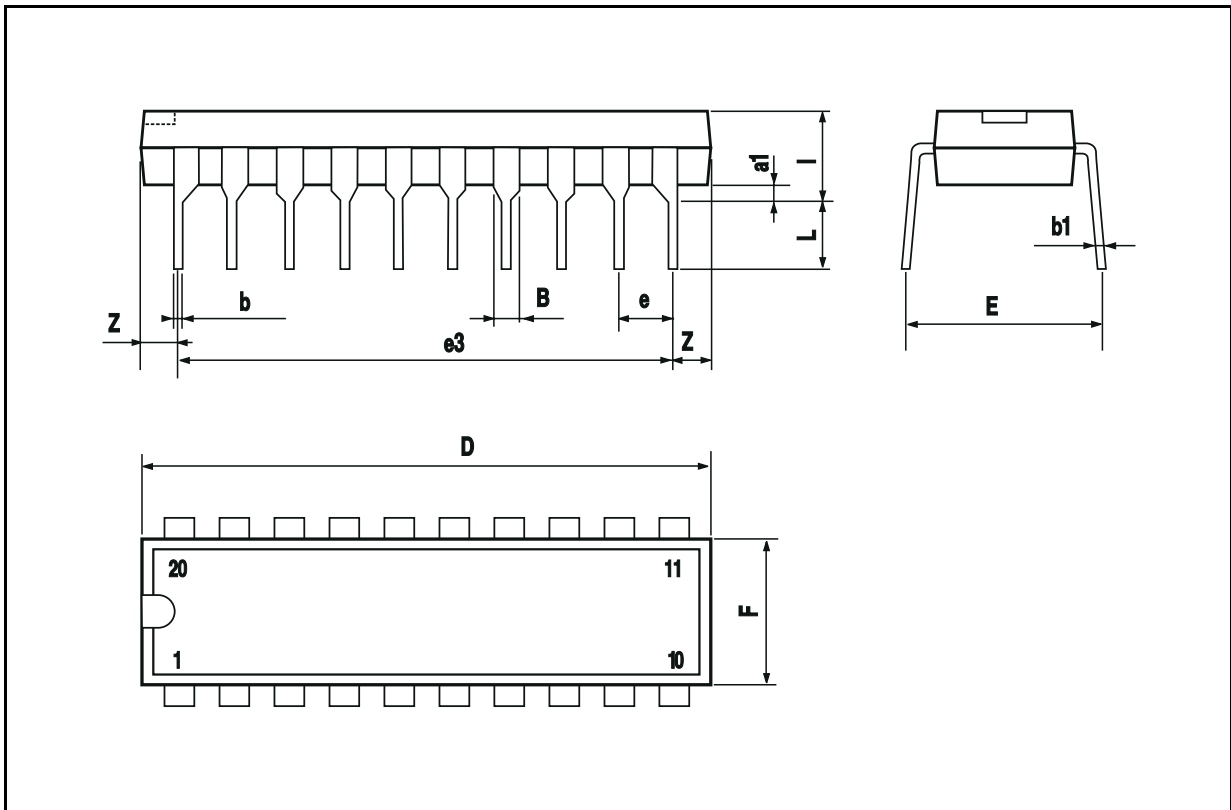

Figure 11. Supply Voltage Rejection vs. Frequency



POWERDIP20 PACKAGE MECHANICAL DATA

DIM.	mm			inch		
	MIN.	TYP.	MAX.	MIN.	TYP.	MAX.
a1	0.51			0.020		
B	0.85		1.40	0.033		0.055
b		0.50			0.020	
b1	0.38		0.50	0.015		0.020
D			24.80			0.976
E		8.80			0.346	
e		2.54			0.100	
e3		22.86			0.900	
F			7.10			0.280
l			5.10			0.201
L		3.30			0.130	
Z			1.27			0.050



Information furnished is believed to be accurate and reliable. However, STMicroelectronics assumes no responsibility for the consequences of use of such information nor for any infringement of patents or other rights of third parties which may result from its use. No license is granted by implication or otherwise under any patent or patent rights of STMicroelectronics. Specification mentioned in this publication are subject to change without notice. This publication supersedes and replaces all information previously supplied. STMicroelectronics products are not authorized for use as critical components in life support devices or systems without express written approval of STMicroelectronics.

The ST logo is a registered trademark of STMicroelectronics

© 1998 STMicroelectronics – Printed in Italy – All Rights Reserved

STMicroelectronics GROUP OF COMPANIES

Australia - Brazil - Canada - China - France - Germany - Italy - Japan - Korea - Malaysia - Malta - Mexico - Morocco - The Netherlands - Singapore - Spain - Sweden - Switzerland - Taiwan - Thailand - United Kingdom - U.S.A.

<http://www.st.com>