

△数 COUNT	訂正事項 DESCRIPTION OF REVISIONS	検出 CHKD	年月日 DATE	△数 COUNT	訂正事項 DESCRIPTION OF REVISIONS	検出 CHKD	年月日 DATE
1	RE-6-1150	K.I.Y	18. 07. 04	△			.. .
2	RE-6-1579	K.I.Y	20. 01. 23	△			.. .

RECOMMENDED LAND PATTERN (FREE)
 (PCB THICKNESS t=1.6mm)

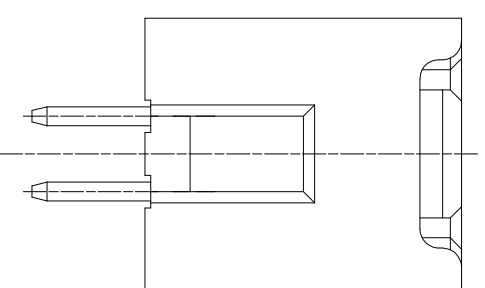

ENGAGEMENT FIGURE (2:1)

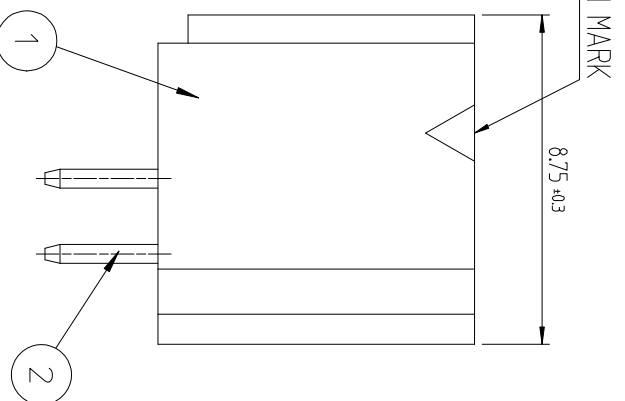
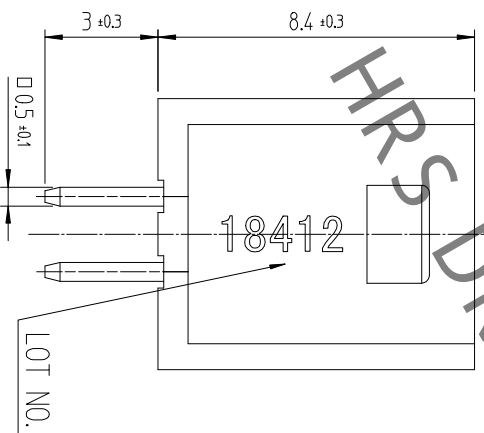
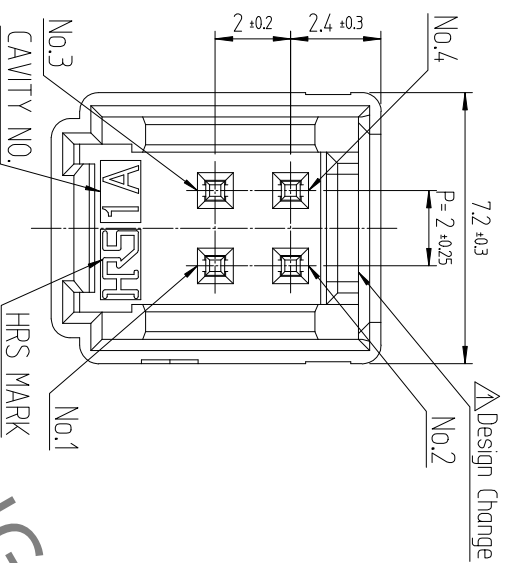
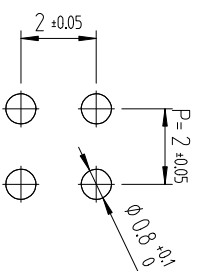
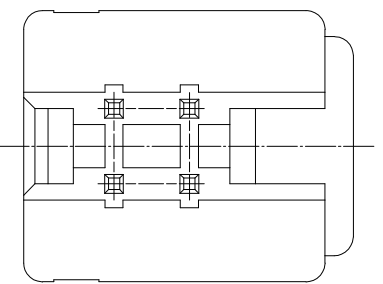
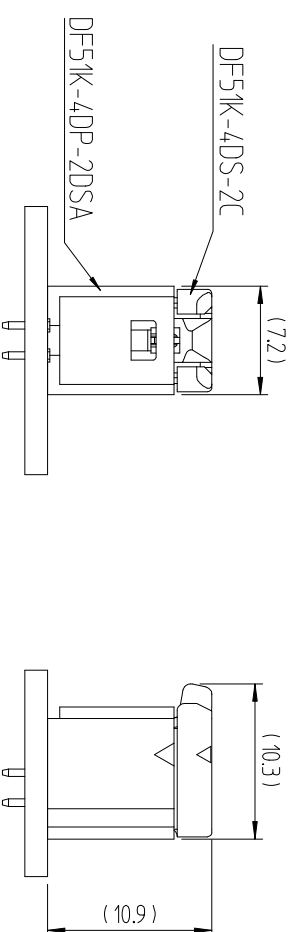

NOTE 1. 1PACK CONTAINS 100PCS.

2. () DIMENSIONS ARE ONLY REFERENCE.

3. UL(File No. E132750) AUTHORIZATION ARTICLE.

C-UL(File No. E132750) AUTHORIZATION ARTICLE.



1	△PA66	UL94V-0, BLACK	2	BRASS	GOLD PLATING 0.1μm MIN, OVER NICKEL 0.5μm MIN
NO.	MATERIAL	FINISH/REMARKS	NO.	MATERIAL	FINISH/REMARKS
CODE NO. (OLD)		DRAWN	CODE NO.		RELEASED
		CHOI 17.12.22 J.S			ENG 20.02.12 DEPT
SCALE 5:1 UNITS mm		DRAWING NO. EDC3-632457	PART NO. DF51K-4DP-2DSA (805)		
		HRS HIROSE KOREA CO.,LTD.	CODE NO. CL 6652-0006-5-805		

