

# Converter - Brake - Inverter Module (CBI 1) SPT IGBT

Three Phase Rectifier	Brake Chopper	Three Phase Inverter
$V_{RRM} = 1600 \text{ V}$	$V_{CES} = 1200 \text{ V}$	$V_{CES} = 1200 \text{ V}$
$I_{DAVM25} = 130 \text{ A}$	$I_{C25} = 19 \text{ A}$	$I_{C25} = 29 \text{ A}$
$I_{FSM} = 300 \text{ A}$	$V_{CE(sat)} = 2.9 \text{ V}$	$V_{CE(sat)} = 2.9 \text{ V}$

**Part name** (Marking on product)

MUBW30-12E6K

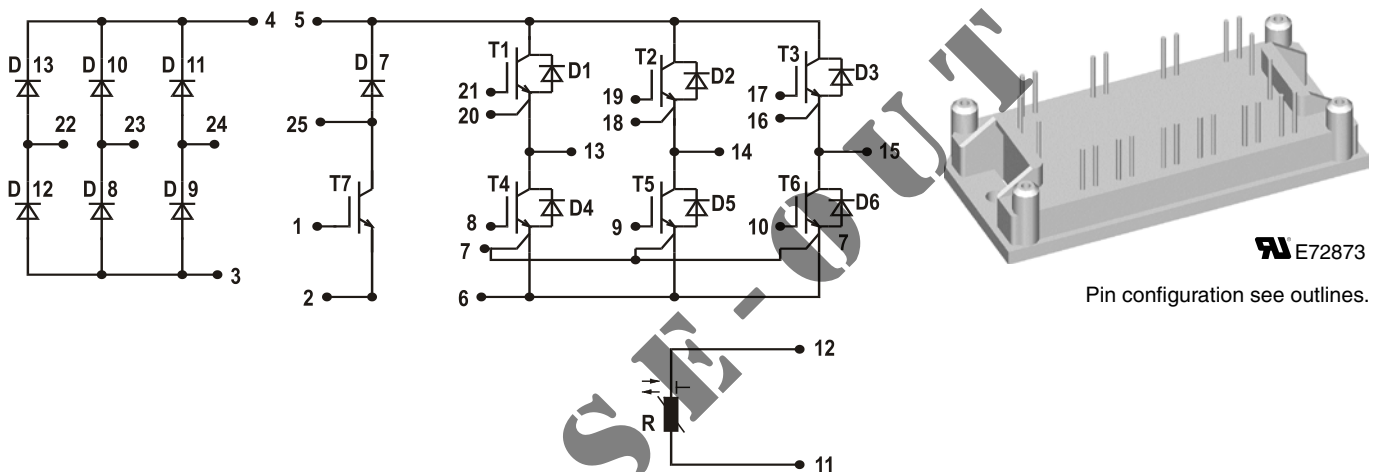

E72873

Pin configuration see outlines.

**Features:**

- High level of integration - only one power semiconductor module required for the whole drive
- Inverter with SPT IGBTs
- low saturation voltage
- positive temperature coefficient
- fast switching
- short tail current
- Epitaxial free wheeling diodes with hiperfast and soft reverse recovery
- Industry standard package with insulated copper base plate and soldering pins for PCB mounting
- Temperature sense included

**Application:**

- AC motor drives with
- Input from single or three phase grid
- Three phase synchronous or asynchronous motor
- Electric braking operation

**Package:**

- UL registered
- Industry standard E1-pack

**Output Inverter T1 - T6**

Symbol	Definitions	Conditions	Ratings			Unit	
			min.	typ.	max.		
$V_{CES}$	collector emitter voltage	$T_{VJ} = 25^{\circ}\text{C to } 150^{\circ}\text{C}$			1200	V	
$V_{GES}$	max. DC gate voltage	continuous			$\pm 20$	V	
$V_{GEM}$	max. transient collector gate voltage	transient			$\pm 30$	V	
$I_{C25}$	collector current	$T_C = 25^{\circ}\text{C}$			30	A	
$I_{C80}$		$T_C = 80^{\circ}\text{C}$			21	A	
$P_{tot}$	total power dissipation	$T_C = 25^{\circ}\text{C}$			130	W	
$V_{CE(sat)}$	collector emitter saturation voltage	$I_C = 30\text{ A}; V_{GE} = 15\text{ V}$			3.1 3.8	V V	
$V_{GE(th)}$	gate emitter threshold voltage	$I_C = 0.6\text{ mA}; V_{GE} = V_{CE}$	$T_{VJ} = 25^{\circ}\text{C}$	4.5		6.5	V
$I_{CES}$	collector emitter leakage current	$V_{CE} = V_{CES}; V_{GE} = 0\text{ V}$	$T_{VJ} = 25^{\circ}\text{C}$ $T_{VJ} = 125^{\circ}\text{C}$		0.6	1 mA mA	
$I_{GES}$	gate emitter leakage current	$V_{CE} = 0\text{ V}; V_{GE} = \pm 20\text{ V}$			200	nA	
$C_{ies}$	input capacitance	$V_{CE} = 25\text{ V}; V_{GE} = 0\text{ V}; f = 1\text{ MHz}$			1180	pF	
$Q_{G(on)}$	total gate charge	$V_{CE} = 600\text{ V}; V_{GE} = 15\text{ V}; I_C = 20\text{ A}$			100	nC	
$t_{d(on)}$	turn-on delay time	inductive load $T_{VJ} = 125^{\circ}\text{C}$ $V_{CE} = 600\text{ V}; I_C = 20\text{ A}$ $V_{GE} = \pm 15\text{ V}; R_G = 68\ \Omega$			210	ns	
$t_r$	current rise time				110	ns	
$t_{d(off)}$	turn-off delay time				320	ns	
$t_f$	current fall time				180	ns	
$E_{on}$	turn-on energy per pulse				4.1	mJ	
$E_{off}$	turn-off energy per pulse				1.5	mJ	
$I_{CM}$	reverse bias safe operating area	RBSOA; $V_{GE} = \pm 15\text{ V}; R_G = 68\ \Omega$ $L = 100\ \mu\text{H};$ damped induct. load $T_{VJ} = 125^{\circ}\text{C}$ $V_{CEmax} = V_{CES} - L_S di/dt$			45	A	
$t_{SC}$ (SCSOA)	short circuit safe operating area	$V_{GE} = 900\text{ V}; V_{GE} = \pm 15\text{ V};$ $R_G = 68\ \Omega;$ non-repetitive	$T_{VJ} = 125^{\circ}\text{C}$		10	$\mu\text{s}$	
$R_{thJC}$	thermal resistance junction to case	(per IGBT)			0.95	K/W	
$R_{thCH}$	thermal resistance case to heatsink	(per IGBT)			0.35	K/W	

**Output Inverter D1 - D6**

Symbol	Definitions	Conditions	Ratings			Unit
			min.	typ.	max.	
$V_{RRM}$	max. repetitive reverse voltage	$T_{VJ} = 150^{\circ}\text{C}$			1200	V
$I_{F25}$	forward current	$T_C = 25^{\circ}\text{C}$			49	A
$I_{F80}$		$T_C = 80^{\circ}\text{C}$			32	A
$V_F$	forward voltage	$I_F = 30\text{ A}; V_{GE} = 0\text{ V}$	$T_{VJ} = 25^{\circ}\text{C}$ $T_{VJ} = 125^{\circ}\text{C}$		2.9	V V
$I_{RM}$	max. reverse recovery current	$V_R = 600\text{ V}$ $di_F/dt = -500\text{ A}/\mu\text{s}$ $I_F = 30\text{ A}; V_{GE} = 0\text{ V}$	$T_{VJ} = 125^{\circ}\text{C}$		27	A
$t_{rr}$	reverse recovery time				150	ns
$E_{rec(off)}$	reverse recovery energy				tbd	$\mu\text{J}$
$R_{thJC}$	thermal resistance junction to case	(per diode)			0.9	K/W
$R_{thCH}$	thermal resistance case to heatsink	(per diode)			0.3	K/W

 $T_C = 25^{\circ}\text{C}$  unless otherwise stated

**Brake Chopper T7**

Symbol	Definitions	Conditions	Ratings			Unit
			min.	typ.	max.	
$V_{CES}$	collector emitter voltage	$T_{VJ} = 25^{\circ}\text{C to } 150^{\circ}\text{C}$			1200	V
$V_{GES}$	max. DC gate voltage	continuous			$\pm 20$	V
$V_{GEM}$	max. transient collector gate voltage	transient			$\pm 30$	V
$I_{C25}$	collector current	$T_C = 25^{\circ}\text{C}$			19	A
$I_{C80}$		$T_C = 80^{\circ}\text{C}$			13	A
$P_{tot}$	total power dissipation	$T_C = 25^{\circ}\text{C}$			90	W
$V_{CE(sat)}$	collector emitter saturation voltage	$I_C = 15\text{ A}; V_{GE} = 15\text{ V}$			2.9 3.5	V V
$V_{GE(th)}$	gate emitter threshold voltage	$I_C = 0.4\text{ mA}; V_{GE} = V_{CE}$	4.5		6.5	V
$I_{CES}$	collector emitter leakage current	$V_{CE} = V_{CES}; V_{GE} = 0\text{ V}$			0.8	mA mA
$I_{GES}$	gate emitter leakage current	$V_{CE} = 0\text{ V}; V_{GE} = \pm 20\text{ V}$			100	nA
$C_{ies}$	input capacitance	$V_{CE} = 25\text{ V}; V_{GE} = 0\text{ V}; f = 1\text{ MHz}$			600	pF
$Q_{G(on)}$	total gate charge	$V_{CE} = 600\text{ V}; V_{GE} = 15\text{ V}; I_C = 10\text{ A}$			45	nC
$t_{d(on)}$	turn-on delay time	inductive load $V_{CE} = 600\text{ V}; I_C = 10\text{ A};$ $V_{GE} = \pm 15\text{ V}; R_G = 82\ \Omega$ $T_{VJ} = 125^{\circ}\text{C}$			45	ns
$t_r$	current rise time		40	ns		
$t_{d(off)}$	turn-off delay time		290	ns		
$t_f$	current fall time		60	ns		
$E_{on}$	turn-on energy per pulse		1.2	mJ		
$E_{off}$	turn-off energy per pulse		1.1	mJ		
$I_{CM}$	reverse bias safe operating area	RBSOA; $V_{GE} = \pm 15\text{ V}; R_G = 82\ \Omega$ $L = 100\ \mu\text{H};$ clamped induct. load $V_{CEmax} = V_{CES} - L_S di/dt$ $T_{VJ} = 125^{\circ}\text{C}$			20	A
$t_{SC}$ (SCSOA)	short circuit safe operating area	$V_{CE} = 720\text{ V}; V_{GE} = \pm 15\text{ V};$ $R_G = 82\ \Omega;$ non-repetitive $T_{VJ} = 125^{\circ}\text{C}$			10	$\mu\text{s}$
$R_{thJC}$	thermal resistance junction to case	(per IGBT)			1.35	K/W
$R_{thCH}$	thermal resistance case to heatsink	(per IGBT)			0.45	K/W

**Brake Chopper D7**

Symbol	Definitions	Conditions	Ratings			Unit
			min.	typ.	max.	
$V_{RRM}$	max. repetitive reverse voltage	$T_{VJ} = 150^{\circ}\text{C}$			1200	V
$I_{F25}$	forward current	$T_C = 25^{\circ}\text{C}$			15	A
$I_{F80}$		$T_C = 80^{\circ}\text{C}$			10	A
$V_F$	forward voltage	$I_F = 15\text{ A}; V_{GE} = 0\text{ V}$			3.5	V
					2.0	V
$I_R$	reverse current	$V_R = V_{RRM}$			0.06	mA mA
					0.2	
$I_{RM}$	max. reverse recovery current	$V_R = 600\text{ V}; I_F = 10\text{ A}$ $di_F/dt = -400\text{ A}/\mu\text{s}$ $T_{VJ} = 125^{\circ}\text{C}$			13	A
$t_{rr}$	reverse recovery time		110	ns		
$R_{thJC}$	thermal resistance junction to case	(per diode)			2.5	K/W
$R_{thCH}$	thermal resistance case to heatsink	(per diode)			0.85	K/W

 $T_C = 25^{\circ}\text{C}$  unless otherwise stated

Input Rectifier Bridge D8 - D13					
Symbol	Definitions	Conditions		Maximum Ratings	
$V_{RRM}$	max. repetitive reverse voltage			1600	V
$I_{FAV}$	average forward current	sine 180°	$T_C = 80^\circ\text{C}$	31	A
$I_{DAVM}$	max. average DC output current	rectangular; $d = 1/3$ ; bridge	$T_C = 80^\circ\text{C}$	89	A
$I_{FSM}$	max. surge forward current	$t = 10\text{ ms}$ ; sine 50 Hz	$T_C = 25^\circ\text{C}$	320	A
$P_{tot}$	total power dissipation	$T_C = 25^\circ\text{C}$		80	W

Symbol	Conditions	Characteristic Values			Unit	
		min.	typ.	max.		
$V_F$	forward voltage	$I_F = 30\text{ A}$	$T_{VJ} = 25^\circ\text{C}$	1.0	1.35	V
			$T_{VJ} = 125^\circ\text{C}$	1.1		V
$I_R$	reverse current	$V_R = V_{RRM}$	$T_{VJ} = 25^\circ\text{C}$	0.4	0.02	mA
			$T_{VJ} = 125^\circ\text{C}$		mA	
$R_{thJC}$	thermal resistance junction to case	(per diode)	$T_{VJ} = 25^\circ\text{C}$		1.4	K/W
$R_{thCH}$	thermal resistance case to heatsink	(per diode)		0.45		K/W

Temperature Sensor NTC							
Symbol	Definitions	Conditions	Ratings			Unit	
			min.	typ.	max.		
$R_{25}$	resistance		$T_C = 25^\circ\text{C}$	4.45	4.7	5.0	k $\Omega$
$B_{25/85}$					3510		K

Module						
Symbol	Definitions	Conditions	Ratings			Unit
			min.	typ.	max.	
$T_{VJ}$	operating temperature		-40		125	$^\circ\text{C}$
$T_{VJM}$	max. virtual junction temperature				150	$^\circ\text{C}$
$T_{stg}$	storage temperature		-40		125	$^\circ\text{C}$
$V_{ISOL}$	isolation voltage	$I_{ISOL} \leq 1\text{ mA}$ ; 50/60 Hz			2500	V~
$M_d$	mounting torque	(M4)	2.0		2.2	Nm
$d_S$	creep distance on surface		12.7			mm
$d_A$	strike distance through air		12.7			mm
<b>Weight</b>				40		g

### Equivalent Circuits for Simulation

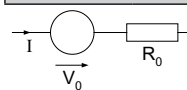

Symbol	Definitions	Conditions	Ratings			Unit
			min.	typ.	max.	
$V_0$	rectifier diode	D8 - D13	$T_{VJ} = 125^\circ\text{C}$	0.90		V
$R_0$				9		m $\Omega$
$V_0$	IGBT	T1 - T6	$T_{VJ} = 125^\circ\text{C}$	1.10		V
$R_0$				90		m $\Omega$
$V_0$	free wheeling diode	D1 - D6	$T_{VJ} = 125^\circ\text{C}$	1.5		V
$R_0$				14		m $\Omega$
$V_0$	IGBT	T7	$T_{VJ} = 125^\circ\text{C}$	1.5		V
$R_0$				120		m $\Omega$
$V_0$	free wheeling diode	D7	$T_{VJ} = 125^\circ\text{C}$	1.46		V
$R_0$				63		m $\Omega$

$T_C = 25^\circ\text{C}$  unless otherwise stated



Input Rectifier Bridge D8 - D13

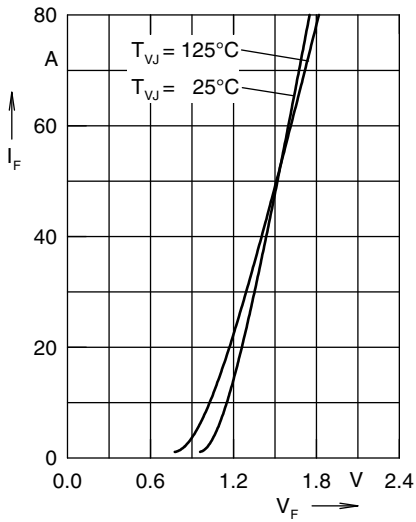

Fig. 1 Forward current versus voltage drop per diode

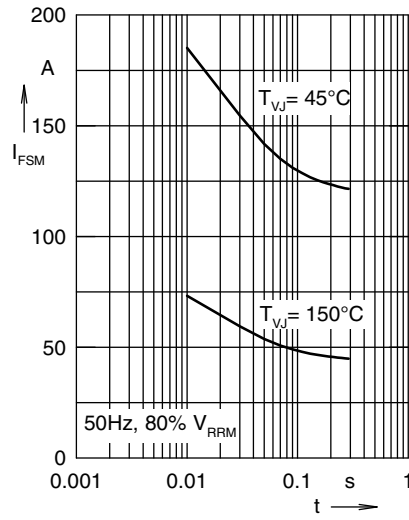

Fig. 2 Surge overload current

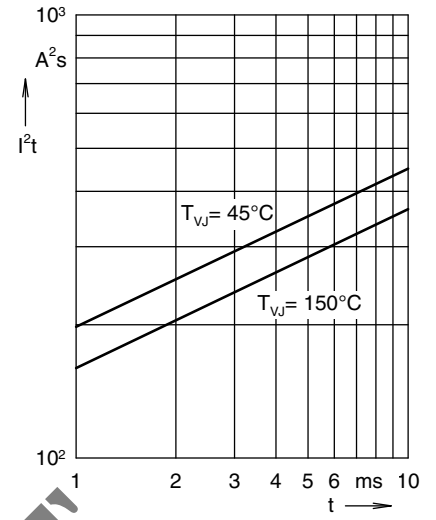

Fig. 3 I<sup>2</sup>t versus time per diode

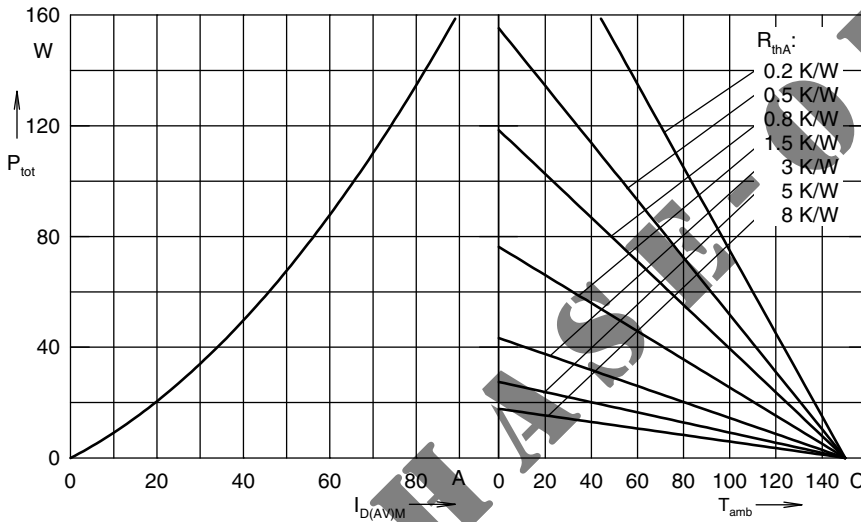

Fig. 4 Power dissipation versus direct output current and ambient temperature, sin 180° Fig.

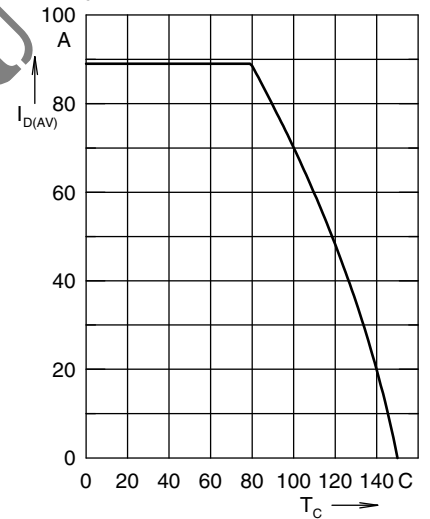

Fig. 5 Max. forward current vs. case temperature

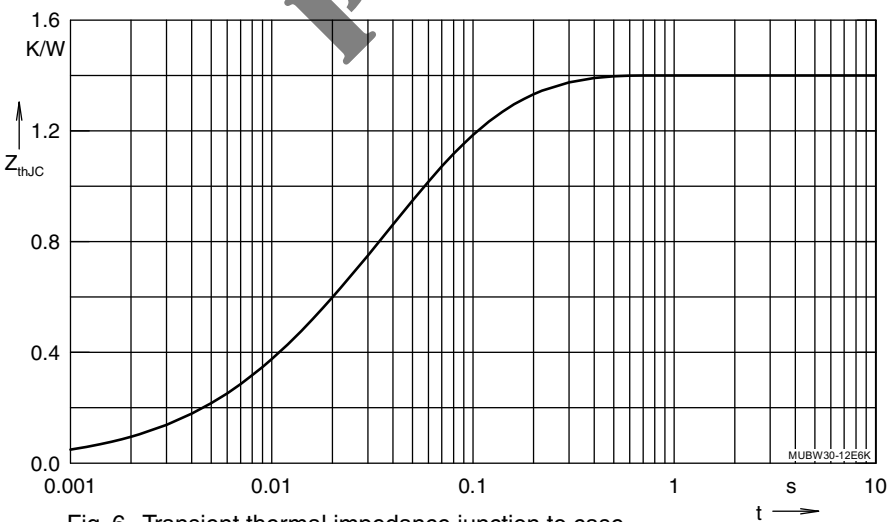

Fig. 6 Transient thermal impedance junction to case

Output Inverter T1 - T6 / D1 - D6

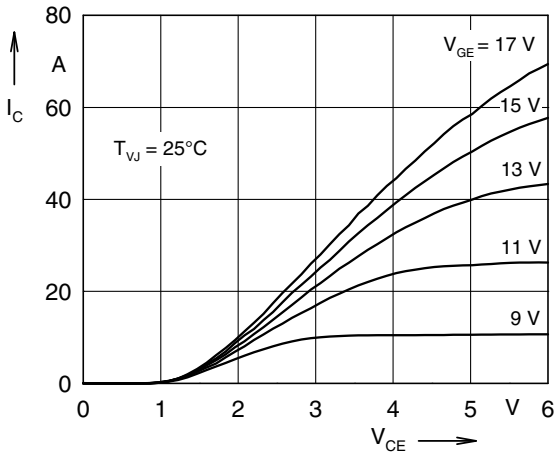

Fig. 7 Typ. output characteristics

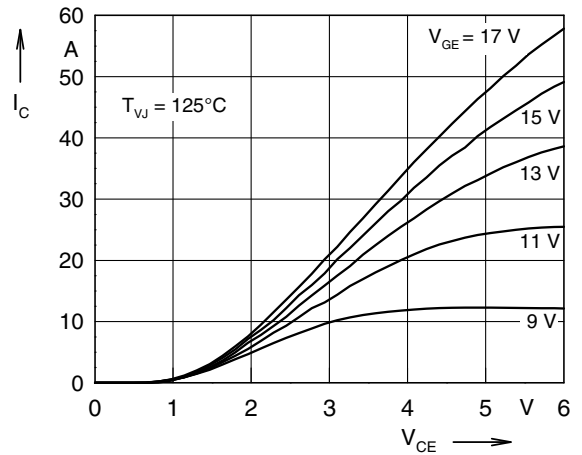

Fig. 8 Typ. output characteristics

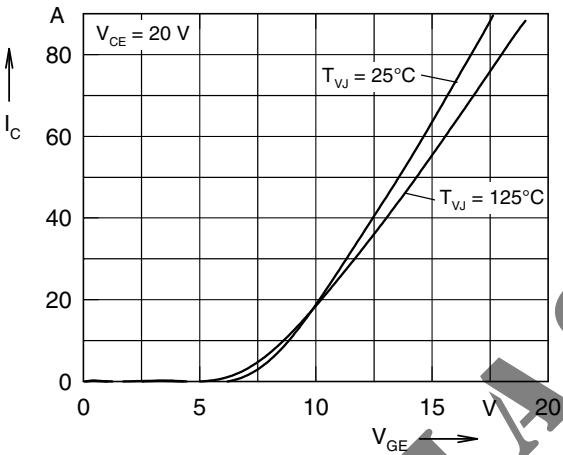

Fig. 9 Typ. transfer characteristics

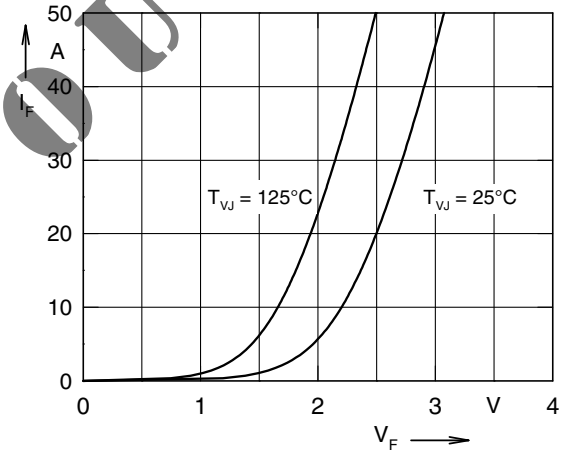

Fig. 10 Typ. forward characteristics of free wheeling diode

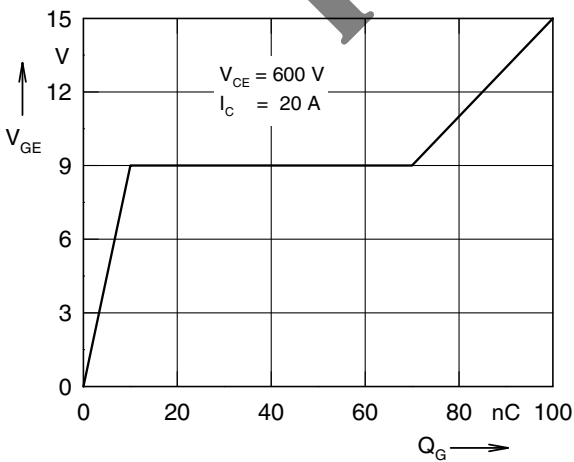

Fig. 11 Typ. turn on gate charge

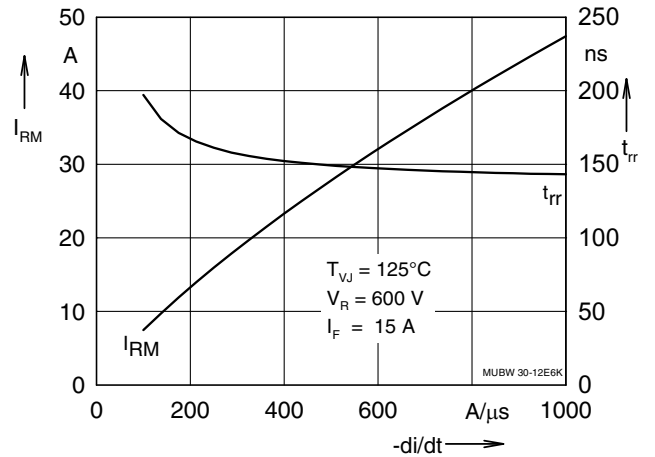

Fig. 12 Typ. turn off char. of free wheeling diode

**Output Inverter T1 - T6 / D1 - D6**

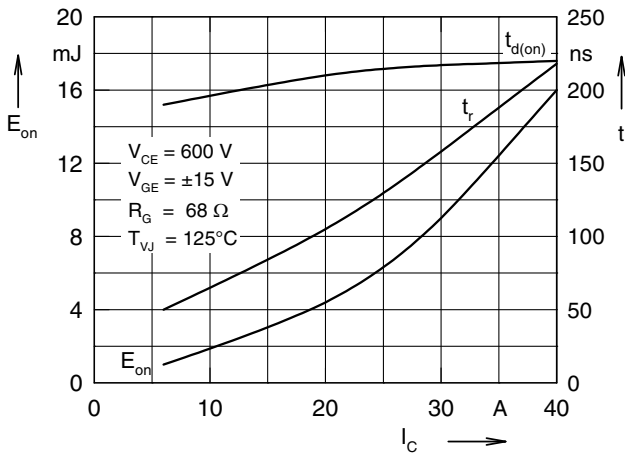

Fig. 13 Typ. turn on energy and switching times versus collector current

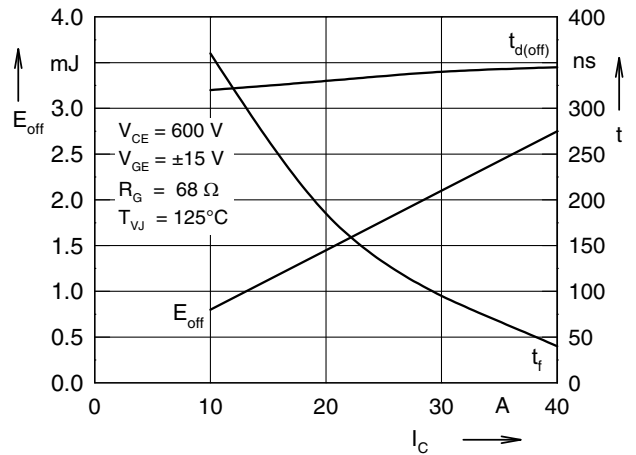

Fig. 14 Typ. turn off energy and switching times versus collector current

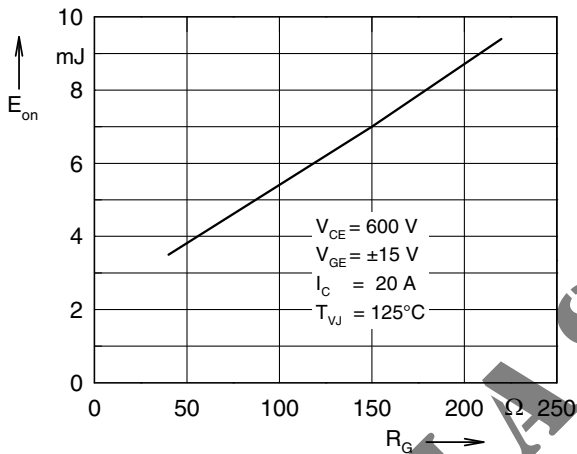

Fig. 15 Typ. turn on energy versus gate resistor

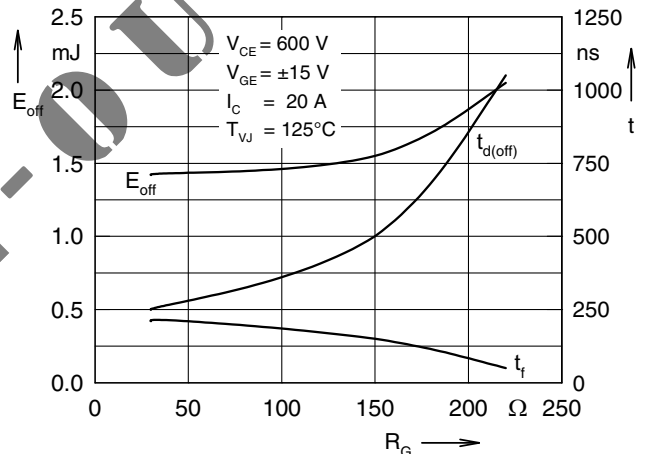

Fig. 16 Typ. turn off energy and switching times versus gate resistor

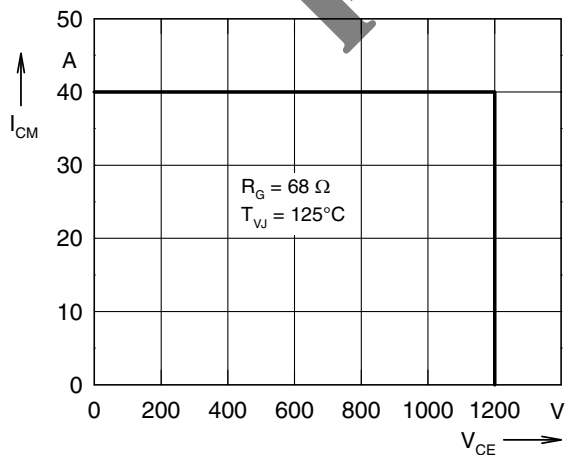

Fig. 17 Reverse biased safe operating area

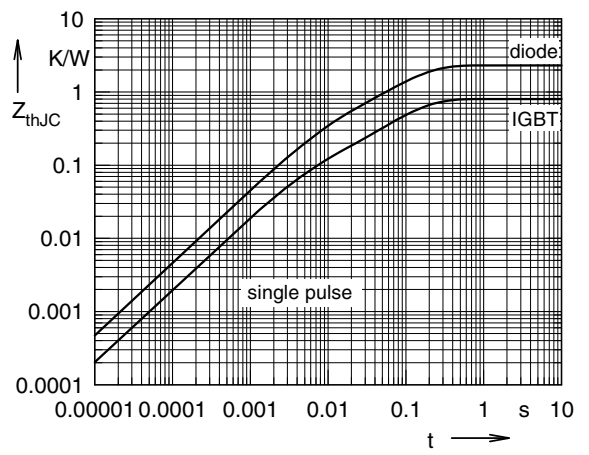

Fig. 18 Typ. transient thermal impedance



## Brake Chopper T7 / D7

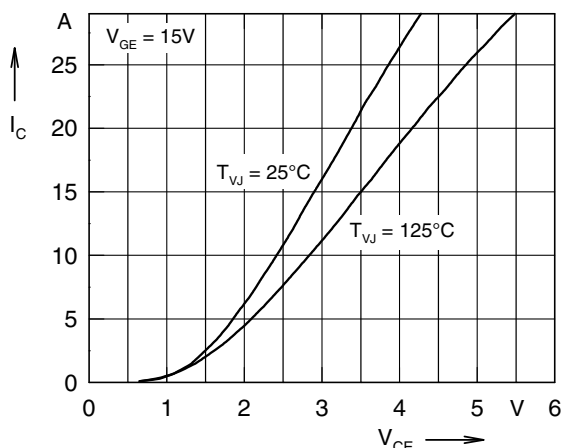

Fig. 19 Typ. output characteristics

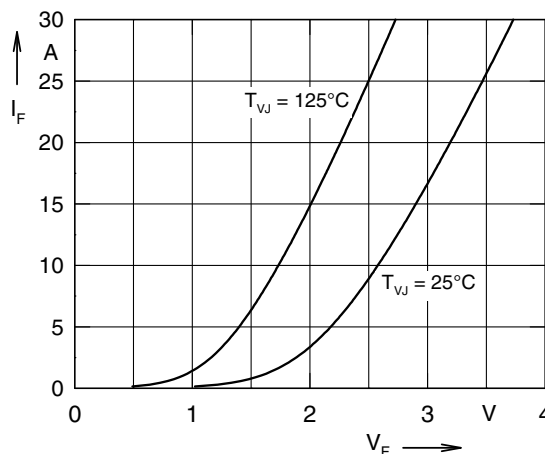

Fig. 20 Typ. forward characteristics of free wheeling diode

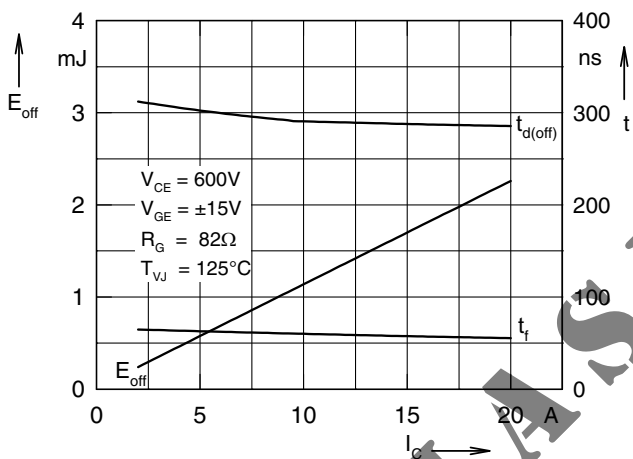

Fig. 21 Typ. turn off energy and switching times versus collector current

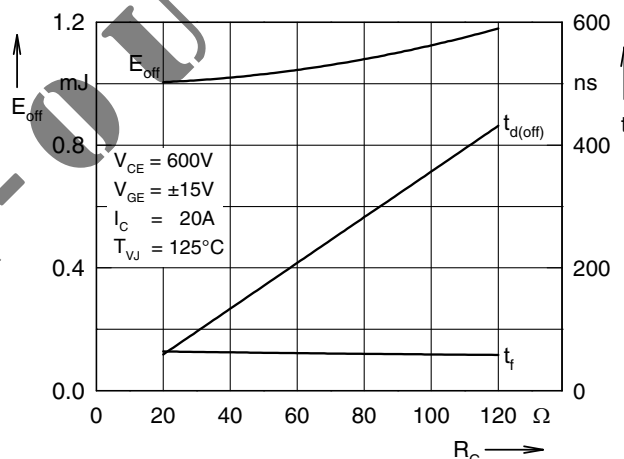

Fig. 22 Typ. turn off energy and switching times versus gate resistor

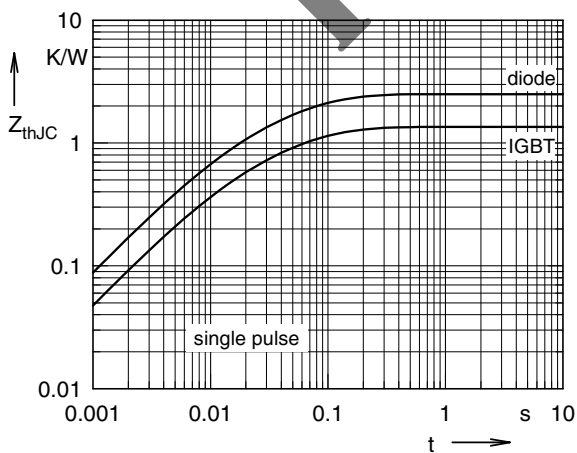

Fig. 23 Typ. transient thermal impedance

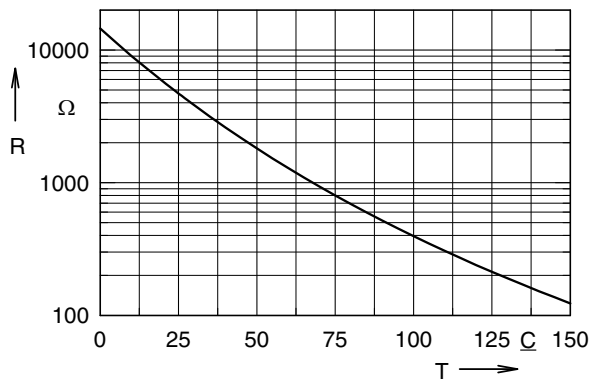

Fig. 24 Typ. thermistor resistance versus temperature