

# ROHM Switching Regulator Solutions

## Evaluation Board: Step-down Switching Regulator With Built-in Power MOSFET

BD9673EFJ / BD9876EFJ (5V | 1.5A / 2.75A Output)

No.0000000013

### ●Introduction

This application note will provide the steps necessary to operate and evaluate ROHM's step-down switching regulator using the BD9673EFJ/BD9876EFJ evaluation boards. Component selection, board layout recommendations, operation procedures and application data is provided.

### ●Description

This evaluation board has been developed for ROHM's step-down switching regulator customers evaluating BD9673EFJ and/or BD9876EFJ. While accepting a wide power supply of 7-42V, a step down output of 1.2V/1.8V/3.3V/5V or any other user defined voltage can be produced. The ICs have an internal 200mohm Nch MOSFET (3.5A max) and a synchronization frequency range of 200 kHz to 500 kHz. A Soft Start circuit prevents in-rush current during startup along with UVLO (low voltage error prevention circuit) and TSD (thermal shutdown detection) protection circuits. An EN pin allows for simple ON/OFF control of the IC to reduce standby current consumption.

### ●Applications

For general devices that have 12V/24V lines

### ●Evaluation Board Operating Limits and Absolute Maximum Ratings

Parameter	Symbol	Limit			Unit	Conditions	
		MIN	TYP	MAX			
<b>Supply Voltage</b>							
	BD9673EFJ	VCC	7	-	24	V	24V for Eval board operation
	BD9876EFJ	VCC	7	-	24	V	24V for Eval board operation
<b>Output Voltage / Current</b>							
	BD9673EFJ	VOUT	1*	-	VCCx0.7	V	*Restricted by minimum on pulse typ. 200ns
	BD9876EFJ	VOUT	1*	-	VCCx0.7	V	*Restricted by minimum on pulse typ. 200ns
	BD9673EFJ	IOUT	-	-	1.5	A	
	BD9876EFJ	IOUT	-	-	2.75	A	

### ●Evaluation Board

Below is the evaluation board with the BD9673EFJ. BD9876EFJ eval board uses the same components and board layout

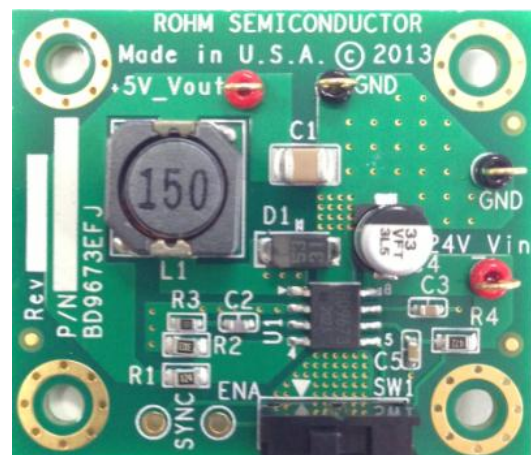
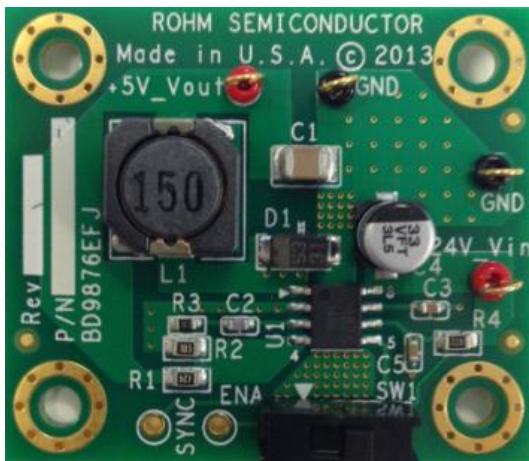

## ● Evaluation Board Schematic

Below is the evaluation board schematic for BD9673EFJ. BD9876EFJ eval board uses the same schematic

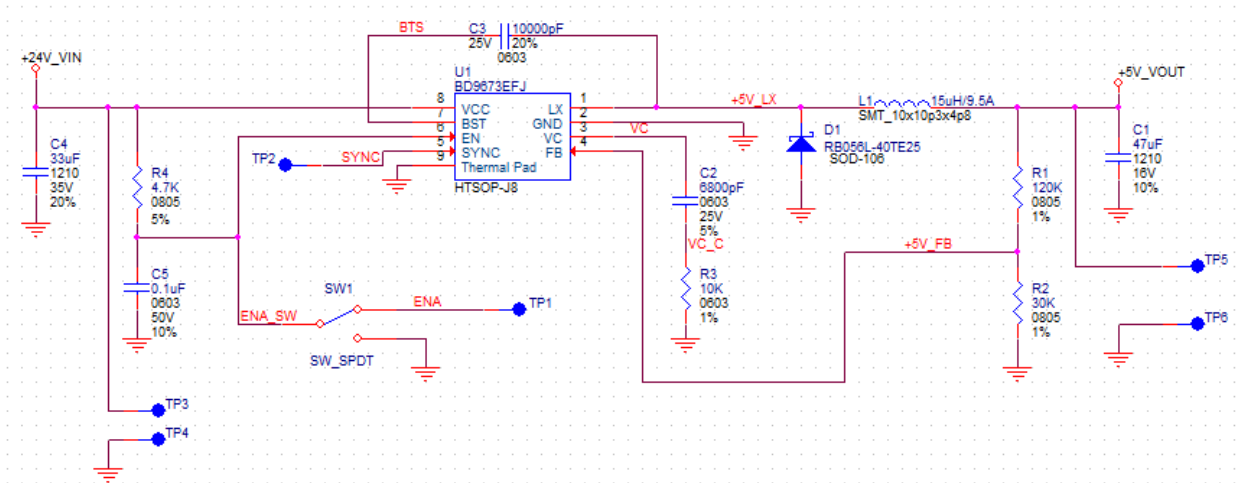

## ● Evaluation Board I/O

Below is the reference application circuit that shows the inputs (Vcc, EN and Sync) and the output (Vout)

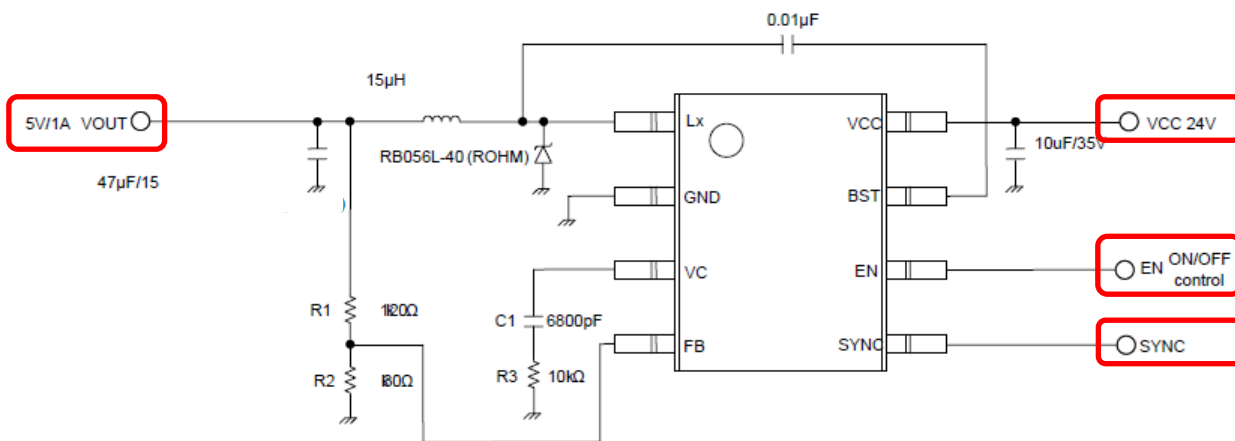

## ● Evaluation Board Operation Procedures

Below is the procedure to operate the evaluation board

1. Connect GND to a GND pin on the evaluation board
2. Connect Vcc to the +24V\_Vin pin. This will provide Vcc to the Vcc pin of the IC
  - i. Note: EN pin is pulled high as default
3. Now output power can be measured from the +5V\_Vout pin on the evaluation board with a load attached. The load can be increased up to 2.75A MAX.

●Reference Graphs Application Data for BD9673EFJ

Below graphs show efficiency, frequency response and load characteristics of the BD9673EFJ eval board.

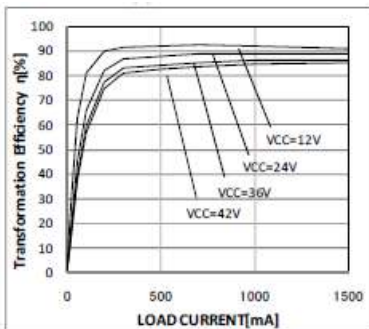

Electric Power Conversion Rate

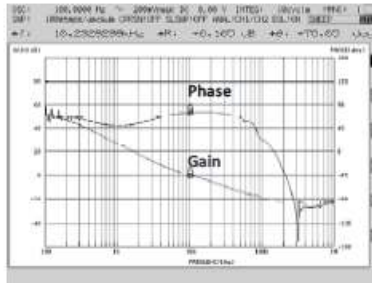

Frequency Response Characteristics (Io=0.5A)

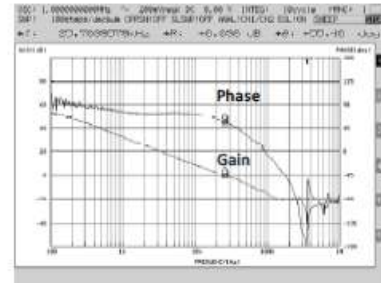

Frequency Response Characteristics (Io=1.0A)

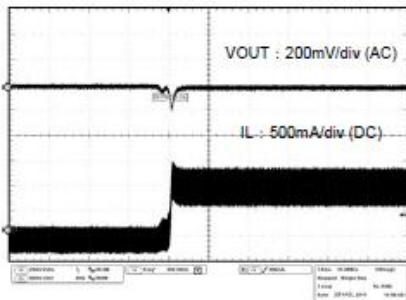

Load Response Characteristics (Io=0A→1.5A)

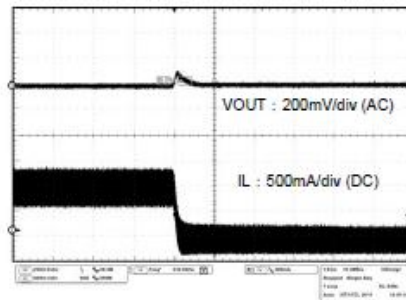

Load Response Characteristics (Io=1.5A→0A)

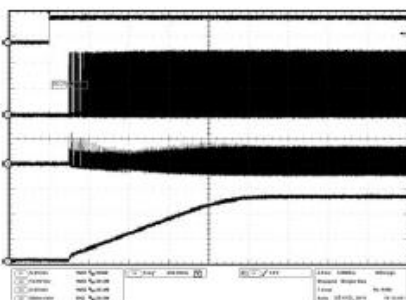

startup Waveform

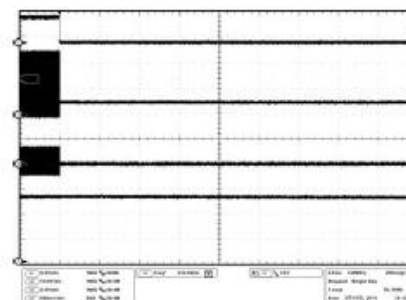

Stop Waveform

●Reference Graphs Application Data for BD9876EFJ

Below graphs show efficiency, frequency response and load characteristics of the BD9876EFJ eval board.

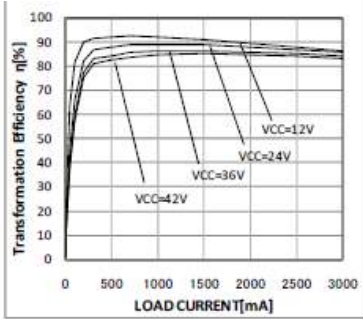

Electric Power Conversion Rate

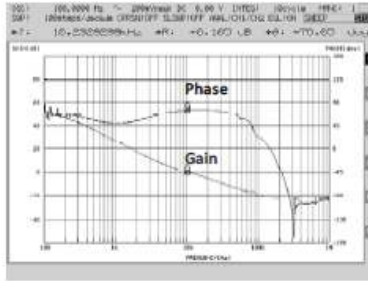

Frequency Response Characteristics ( $I_o=0.5A$ )

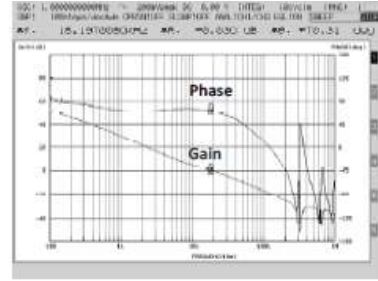

Frequency Response Characteristics ( $I_o=3.0A$ )

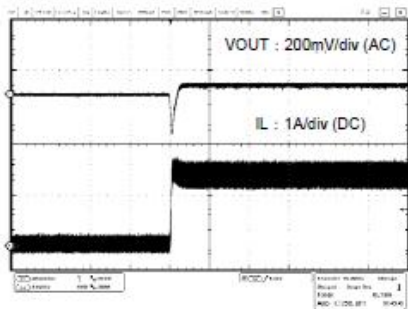

Load Response Characteristics ( $I_o=0A \rightarrow 3.0A$ )

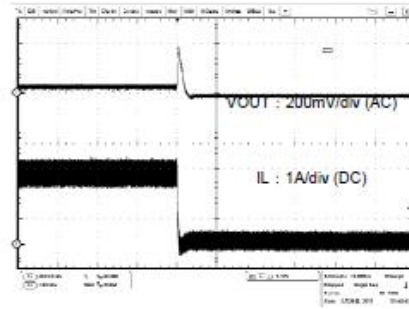

Load Response Characteristics ( $I_o=3.0A \rightarrow 0A$ )

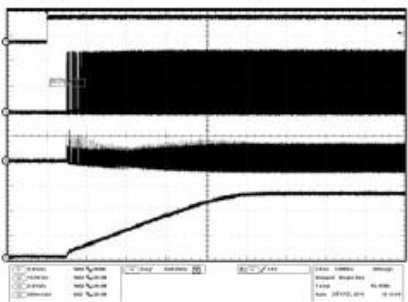

startup Waveform

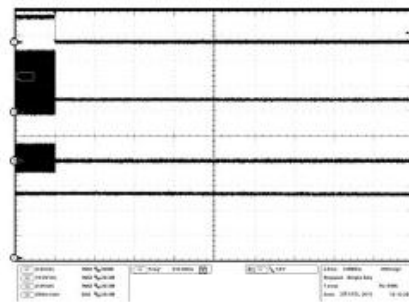

Stop Waveform

## ● Evaluation Board Layout Guidelines

Below are the guidelines that have been followed and recommended for BD9673 and BD9876 designs

Layout is a critical portion of good power supply design. There are several signals paths that conduct fast changing currents or voltages that can interact with stray inductance or parasitic capacitance to generate noise or degrade the power supplies performance. To help eliminate these problems, the VCC pin should be bypassed to ground with a low ESR ceramic bypass capacitor with B dielectric. Care should be taken to minimize the loop area formed by the bypass capacitor connections, the VCC pin, and the anode of the catch diode. See Fig.28 for a PCB layout example. The GND pin should be tied directly to the thermal pad under the IC and the thermal pad.

The thermal pad should be connected to any internal PCB ground planes using multiple VIAs directly under the IC. The LX pin should be routed to the cathode of the catch diode and to the output inductor. Since the LX connection is the switching node, the catch diode and output inductor should be located close to the LX pins, and the area of the PCB conductor minimized to prevent excessive capacitive coupling. For operation at full rated load, the top side ground area must provide adequate heat dissipating area. The additional external components can be placed approximately as shown. It may be possible to obtain acceptable performance with alternate PCB layouts; however this layout has been shown to produce good results and is meant as a guideline.

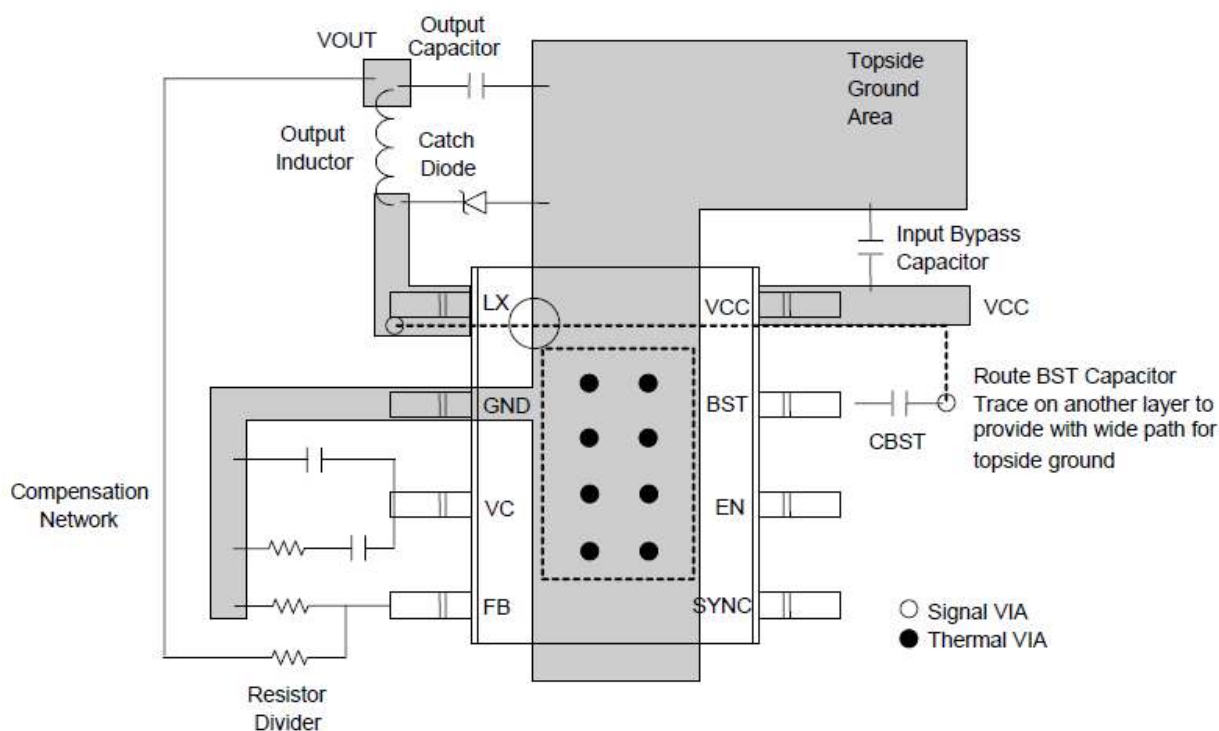

### Note:

For applications operating at or near maximum voltage conditions (45V max.), additional precautions regarding heat dissipation need to be considered during board layout. The provided evaluation board is a 2-layer board meant for evaluation purposes only. At maximum conditions, the IC's internal thermal shutdown detection circuit will be potentially initiated and the output disabled until the junction temperature falls. For final designs operating near these conditions, we recommend using one of the below PCB options for better heat dissipation of the IC.

- 1) Use of a 4-layer PCB with internal GND planes connected to the IC GND pins
- 2) Use of a 2-layer PCB with a heat sink attached to the IC package
- 3) Use of a 2-layer PCB with a copper plane (>1oz) attached to the IC

### ●Application Components Selection Method

#### (1) Inductor

Something of the shield Type that Fulfills the Current Rating (Current value  $I_{pecac}$  below), with low DCR (Direct Current Resistance element) is recommended.

Value of Inductor influences Inductor Ripple Current and becomes the cause of Output Ripple.

In the same way as the formula below, this Ripple Current can be made small for as big as the L value of Coil or as high as the Switching Frequency.

$$I_{peak} = I_{out} + \Delta I_L / 2 \quad [A] \quad (1)$$

$$\Delta I_L = \frac{V_{in} - V_{out}}{L} \times \frac{V_{out}}{V_{in}} \times \frac{1}{f} \quad [A] \quad (2)$$

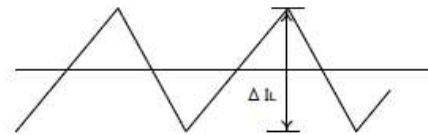

Fig.29 Inductor Current

( $\eta$ : Efficiency,  $\Delta I_L$ : Output Ripple Current,  $f$ : Switching Frequency )

For design value of Inductor Ripple Current, please carry out design tentatively with about 20%~50% of Maximum Input Current.

※When current that exceeds Coil rating flows to the coil, the Coil causes a Magnetic Saturation, and there are cases wherein a decline in efficiency, oscillation of output happens. Please have sufficient margin and select so that Peak Current does not exceed Rating Current of Coil.

#### (2) Output Capacitor

In order for Capacitor to be used in Output to reduce Output Ripple, Low Ceramic Capacitor of ESR is recommended.

Also, for Capacitor Rating, on top of putting into consideration DC Bias Characteristics, please use something whose Maximum Rating has sufficient margin with respect to the Output Voltage.

Output Ripple Voltage is looked for using the following formula.

$$V_{pp} = \Delta I_L \times \frac{1}{2\pi \times f \times C_o} + \Delta I_L \times R_{ESR} \quad [V] \quad \dots (3)$$

Please design in a way that it is held within Capacity Ripple Voltage.

#### (3) Output Voltage Setting

ERROR AMP internal Standard Voltage is 1.0V. Output Voltage is determined as seen in (4) formula.

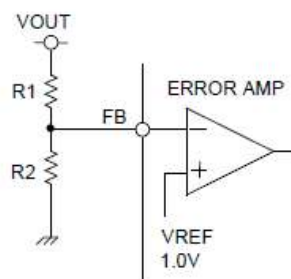

$$V_o = \frac{(R1+R2)}{R2} \times 1.0 \quad [V] \quad \dots (4)$$

Fig.30 Voltage Return Resistance Setting Method

#### (4) Boost Capacitor

Please connect CBST = 0.01 $\mu$ F (Laminate Ceramic Capacitor) between BST Pin-Lx Pins as Output capacitors of Gate Drive Voltage Generator REG(5V).

- (5) About Adjustment of DC/DC Comparator Frequency Characteristics  
Role of Phase compensation element CC1, CC2, RC (See P.7. Example of Reference Application Circuit)

Stability and Responsiveness of Loop are controlled through VC Pin which is the output of Error Amp.  
The combination of zero and pole that determines Stability and Responsiveness is adjusted by the combination of resistor and capacitor that are connected in series to the VC Pin.

DC Gain of Voltage Return Loop can be calculated for using the following formula.

$$A_{dc} = R_I \times G_{CS} \times A_{EA} \times \frac{V_{FB}}{V_{OUT}}$$

Here,  $V_{FB}$  is Feedback Voltage (1.0V).  $A_{EA}$  is Voltage Gain of Error amplifier (typ: 77dB),  
 $G_{CS}$  is the Trans-conductance of Current Detect (typ: 10A/V), and  $R_I$  is the Output Load Resistance value.

There are 2 important poles in the Control Loop of this DC/DC.  
The first occurs with/ through the output resistance of Phase compensation Capacitor (C1) and Error amplifier.  
The other one occurs with/through the Output Capacitor and Load Resistor.  
These poles appear in the frequency written below.

$$f_{p1} = \frac{G_{EA}}{2\pi \times C1 \times A_{EA}}$$

$$f_{p2} = \frac{1}{2\pi \times COUT \times R_I}$$

Here,  $G_{EA}$  is the trans-conductance of Error amplifier (typ: 220  $\mu$ A/V).

Here, in this Control Loop, one zero becomes important. With the zero which occurs because of Phase compensation Capacitor C1 and Phase compensation Resistor R3, the Frequency below appears.

$$f_{z1} = \frac{1}{2\pi \times C1 \times R3}$$

Also, if Output Capacitor is big, and that ESR (RESR) is big, in this Control Loop, there are cases when it has an important, separate zero (ESR zero).

This ESR zero occurs due to ESR of Output Capacitor and Capacitance, and exists in the Frequency below.

$$f_{zESR} = \frac{1}{2\pi \times COUT \times RESR} \quad (\text{ESR zero})$$

In this case, the 3<sup>rd</sup> pole determined with the 2<sup>nd</sup> Phase compensation Capacitor (C2) and Phase Correction Resistor (R3) is used in order to correct the ESR zero results in Loop Gain.

This pole exists in the frequency shown below.

$$f_{p3} = \frac{1}{2\pi \times C2 \times R3} \quad (\text{Pole that corrects ESR zero})$$

The target of Phase compensation design is to create a communication function in order to acquire necessary band and Phase margin.

Cross-over Frequency (band) at which Loop gain of Return Loop becomes "0" is important.  
When Cross-over Frequency becomes low, Power supply Fluctuation Response, Load Response, etc worsens.  
On the other hand, when Cross-over Frequency is too high, instability of the Loop can occur.  
Tentatively, Cross-over Frequency is targeted to be made 1/20 or below of Switching Frequency.

Selection method of Phase Compensation constant is shown below.

1. Phase Compensation Resistor (R3) is selected in order to set to the desired Cross-over Frequency. Calculation of RC is done using the formula below.

$$R3 = \frac{2\pi \times C_{OUT} \times f_c}{G_{EA} \times G_{CS}} \times \frac{V_{OUT}}{V_{FB}}$$

Here,  $f_c$  is the desired Cross-over Frequency. It is made about 1/20 and below of the Normal Switching Frequency ( $f_s$ ).

2. Phase compensation Capacitor (C1) is selected in order to achieve the desired phase margin. In an application that has a representative Inductance value (about several  $\mu\text{H} \sim 20\mu\text{H}$ ), by matching zero of compensation to 1/4 and below of the Cross-over Frequency, sufficient Phase margin can be acquired. C1 can be calculated using the following formula.

$$C1 > \frac{4}{2\pi \times R3 \times f_c}$$

RC is Phase compensation Resistor.

3. Examination whether the second Phase compensation Capacitor C2 is necessary or not is done. If the ESR zero of Output Capacitor exists in a place that is smaller than half of the Switching Frequency, a second Phase compensation Capacitor is necessary. In other words, it is the case wherein the formula below happens.

$$\frac{1}{2\pi \times C_{OUT} \times \text{RESR}} < \frac{f_s}{2}$$

In this case, add the second Phase compensation Capacitor C2, and match the frequency of the third pole to the Frequency  $f_{p3}$  of ESR zero.

C2 is looked for using the following formula.

$$C2 = \frac{C_{OUT} \times \text{RESR}}{R3}$$



### ●Evaluation Board BOM

Below is a table with the build of materials. Part numbers and supplier references are provided.

Item	Qty	Ref	Description	Manufacturer	Part Number
1	1	C1	CAP, CER, 1210, 16 V, 20%, 47 $\mu$ F	Murata	GRM32ER61C476ME15L
2	1	C2	CAP, CER, 0603, NP0, 25 V, 5%, 6800 pF	TDK Corporation	C1608C0G1E682J
3	1	C3	CAP, CER, 0603, X7R, 25 V, 20%, 10000 pF	TDK Corporation	C1608X7R1E103M
4	1	C4	CAP, ALUM, SMD, 20%, 35 V, 33 $\mu$ F	Panasonic Corp	EEE-FT1V330AR
5	1	C5	CAP, CER, 0603, X7R, 50 V, 10%, 0.1 $\mu$ F	AVX Corporation	06035C104KAT2A
6	1	D1	SBD, PMDS / SOD-106, 40 V, 3 A	ROHM Semiconductor	RB056L-40TE25
7	1	L1	INDUCTOR SMD 15UH 3.60A 100KHZ	Signal Transformers	SCRH105RY-150
8	1	R1	RES, SMD, 0805, 1/8 W, 5%, 120 k $\Omega$	ROHM Semiconductor	MCR10EZPJ124
9	1	R2	RES, SMD, 0805, 1/8 W, 5%, 30 k $\Omega$	ROHM Semiconductor	MCR10EZPJ303
10	1	R3	RES, SMD, 0603, 1/8 W, 5%, 10 k $\Omega$	ROHM Semiconductor	MCR03EZPJ103
11	1	R4	RES, SMD, 0805, 1/8 W, 5%, 4.7 k $\Omega$	ROHM Semiconductor	MCR10EZPJ472

\*IC is not shown above. Either BD9673EFJ or BD9876EFJ will be used. Please check IC label on backside of PCB.

## Notes

No copying or reproduction of this document, in part or in whole, is permitted without the consent of ROHM Co.,Ltd.

The content specified herein is subject to change for improvement without notice.

The content specified herein is for the purpose of introducing ROHM's products (hereinafter "Products"). If you wish to use any such Product, please be sure to refer to the specifications, which can be obtained from ROHM upon request.

Examples of application circuits, circuit constants and any other information contained herein illustrate the standard usage and operations of the Products. The peripheral conditions must be taken into account when designing circuits for mass production.

Great care was taken in ensuring the accuracy of the information specified in this document. However, should you incur any damage arising from any inaccuracy or misprint of such information, ROHM shall bear no responsibility for such damage.

The technical information specified herein is intended only to show the typical functions of and examples of application circuits for the Products. ROHM does not grant you, explicitly or implicitly, any license to use or exercise intellectual property or other rights held by ROHM and other parties. ROHM shall bear no responsibility whatsoever for any dispute arising from the use of such technical information.

The Products specified in this document are intended to be used with general-use electronic equipment or devices (such as audio visual equipment, office-automation equipment, communication devices, electronic appliances and amusement devices).

The Products specified in this document are not designed to be radiation tolerant.

While ROHM always makes efforts to enhance the quality and reliability of its Products, a Product may fail or malfunction for a variety of reasons.

Please be sure to implement in your equipment using the Products safety measures to guard against the possibility of physical injury, fire or any other damage caused in the event of the failure of any Product, such as derating, redundancy, fire control and fail-safe designs. ROHM shall bear no responsibility whatsoever for your use of any Product outside of the prescribed scope or not in accordance with the instruction manual.

The Products are not designed or manufactured to be used with any equipment, device or system which requires an extremely high level of reliability the failure or malfunction of which may result in a direct threat to human life or create a risk of human injury (such as a medical instrument, transportation equipment, aerospace machinery, nuclear-reactor controller, fuel-controller or other safety device). ROHM shall bear no responsibility in any way for use of any of the Products for the above special purposes. If a Product is intended to be used for any such special purpose, please contact a ROHM sales representative before purchasing.

If you intend to export or ship overseas any Product or technology specified herein that may be controlled under the Foreign Exchange and the Foreign Trade Law, you will be required to obtain a license or permit under the Law.



Thank you for your accessing to ROHM product informations.  
More detail product informations and catalogs are available, please contact us.

**ROHM Customer Support System**

<http://www.rohm.com/contact/>