

## IR Receiver Modules for Remote Control Systems

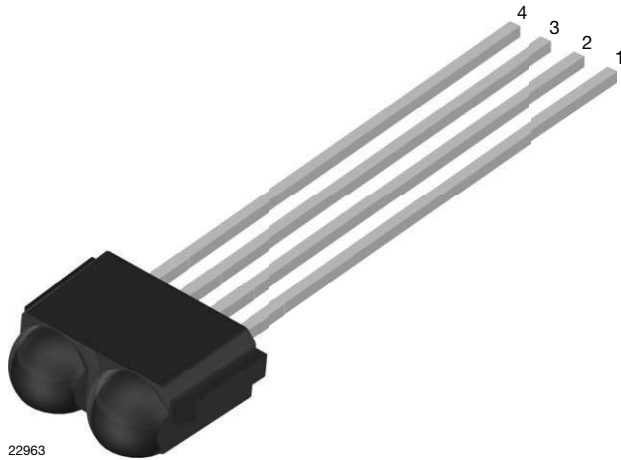

22963

### LINKS TO ADDITIONAL RESOURCES



### DESCRIPTION

The TSOP39... series are miniaturized receiver modules for infrared remote control systems. Two PIN diodes and a preamplifier are assembled on a leadframe, the epoxy package contains an IR filter. The demodulated output signal can be directly connected to digital circuitry for decoding.

The TSOP393.. series devices are optimized to suppress almost all spurious pulses from energy saving lamps like CFLs. These AGC3 devices may also suppress some data signals if continuously transmitted.

The TSOP395.. series contains a very robust AGC5. This series should only be used for critically noisy environments.

These components have not been qualified according to automotive specifications.

### FEATURES

- Very low supply current
- Photo detector and preamplifier in one package
- Internal filter for PCM frequency
- Supply voltage: 2.5 V to 5.5 V
- Improved immunity against ambient light
- Two lenses for high sensitivity
- Insensitive to supply voltage ripple and noise
- Ultra small top-view PCB footprint
- Material categorization: for definitions of compliance please see [www.vishay.com/doc?99912](http://www.vishay.com/doc?99912)



### MECHANICAL DATA

#### Pinning:

1, 4 = GND, 2 =  $V_S$ , 3 = OUT

### ORDERING CODE

TSOP.9.... - 2400 pieces in 6 bags

### BLOCK DIAGRAM

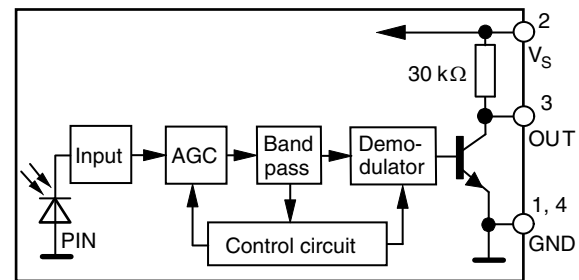

20445-1

### APPLICATION CIRCUIT

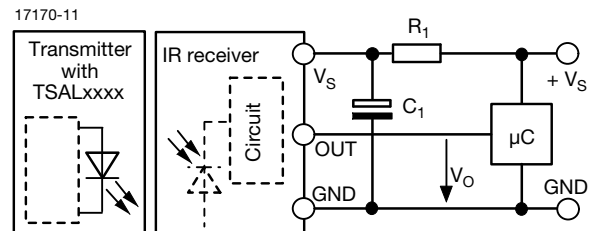

$R_1$  and  $C_1$  recommended to reduce supply ripple for  $V_S < 2.8$  V



| PARTS TABLE       |        |  |  |
|-------------------|--------|--|--|
| AGC               |        | NOISY ENVIRONMENTS<br>AND SHORT BURSTS (AGC3)  | VERY NOISY ENVIRONMENTS<br>AND SHORT BURSTS (AGC5) |
| Carrier frequency | 30 kHz | TSOP39330  | TSOP39530  |
|                   | 33 kHz | TSOP39333  | TSOP39533  |
|                   | 36 kHz | TSOP39336 <sup>(1)</sup>   | TSOP39536  |
|                   | 38 kHz | TSOP39338 <sup>(2)(3)(4)(5)</sup>  | TSOP39538  |
|                   | 40 kHz | TSOP39340  | TSOP39540  |
|                   | 56 kHz | TSOP39356  | TSOP39556  |
| Package           |        | TVCast   |  |
| Pinning           |        | 1, 4 = GND, 2 = V <sub>S</sub> , 3 = OUT   |  |
| Dimensions (mm)   |        | 6.8 W x 2.6 H x 5.3 D  |  |
| Mounting          |        | Leaded   |  |
| Application       |        | Remote control   |  |
| Best choice for   |        | <sup>(1)</sup> MCIR <sup>(2)</sup> Mitsubishi <sup>(3)</sup> RECS-80 Code <sup>(4)</sup> r-map <sup>(5)</sup> XMP-1, XMP-2 |  |
| Special options   |        | • Low voltage option: <a href="http://www.vishay.com/doc?82382">www.vishay.com/doc?82382</a>                               |  |

| ABSOLUTE MAXIMUM RATINGS    |                          |                  |                                |      |
|-----------------------------|--------------------------|------------------|--------------------------------|------|
| PARAMETER                   | TEST CONDITION           | SYMBOL           | VALUE                          | UNIT |
| Supply voltage              |                          | V <sub>S</sub>   | -0.3 to +6                     | V    |
| Supply current              |                          | I <sub>S</sub>   | 3                              | mA   |
| Output voltage              |                          | V <sub>O</sub>   | -0.3 to (V <sub>S</sub> + 0.3) | V    |
| Output current              |                          | I <sub>O</sub>   | 5                              | mA   |
| Junction temperature        |                          | T <sub>J</sub>   | 100                            | °C   |
| Storage temperature range   |                          | T <sub>stg</sub> | -25 to +85                     | °C   |
| Operating temperature range |                          | T <sub>amb</sub> | -25 to +85                     | °C   |
| Power consumption           | T <sub>amb</sub> ≤ 85 °C | P <sub>tot</sub> | 10                             | mW   |
| Soldering temperature       | t ≤ 10 s, 1 mm from case | T <sub>sd</sub>  | 260                            | °C   |

**Note**

- Stresses beyond those listed under “Absolute Maximum Ratings” may cause permanent damage to the device. This is a stress rating only and functional operation of the device at these or any other conditions beyond those indicated in the operational sections of this specification is not implied. Exposure to absolute maximum rating conditions for extended periods may affect the device reliability

| ELECTRICAL AND OPTICAL CHARACTERISTICS (T <sub>amb</sub> = 25 °C, unless otherwise specified) |  |                     |      |      |      |                   |
|---|--|---------------------|------|------|------|-------------------|
| PARAMETER   | TEST CONDITION   | SYMBOL              | MIN. | TYP. | MAX. | UNIT              |
| Supply voltage  |  | V <sub>S</sub>      | 2.5  | -    | 5.5  | V                 |
| Supply current  | E <sub>v</sub> = 0, V <sub>S</sub> = 3.3 V   | I <sub>SD</sub>     | 0.27 | 0.35 | 0.45 | mA                |
|   | E <sub>v</sub> = 40 klx, sunlight  | I <sub>SH</sub>     | -    | 0.45 | -    | mA                |
| Transmission distance   | E <sub>v</sub> = 0, test signal see Fig. 1, IR diode TSAL6200, I <sub>F</sub> = 50 mA  | d                   | -    | 30   | -    | m                 |
| Output voltage low  | I <sub>O</sub> SL = 0.5 mA, E <sub>e</sub> = 0.7 mW/m <sup>2</sup> , test signal see Fig. 1  | V <sub>O</sub> SL   | -    | -    | 100  | mV                |
| Minimum irradiance  | Pulse width tolerance:<br>t <sub>pi</sub> - 5/f <sub>o</sub> < t <sub>po</sub> < t <sub>pi</sub> + 6/f <sub>o</sub> , test signal see Fig. 1 | E <sub>e</sub> min. | -    | 0.08 | 0.12 | mW/m <sup>2</sup> |
| Maximum irradiance  | t <sub>pi</sub> - 5/f <sub>o</sub> < t <sub>po</sub> < t <sub>pi</sub> + 6/f <sub>o</sub> , test signal see Fig. 1                           | E <sub>e</sub> max. | 30   | -    | -    | W/m <sup>2</sup>  |
| Directivity   | Angle of half transmission distance  | φ <sub>1/2</sub>    | -    | ± 45 | -    | °                 |

**TYPICAL CHARACTERISTICS** ( $T_{amb} = 25\text{ }^{\circ}\text{C}$ , unless otherwise specified)

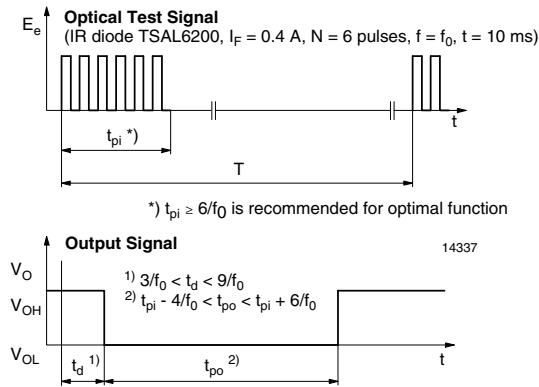

Fig. 1 - Output Active Low

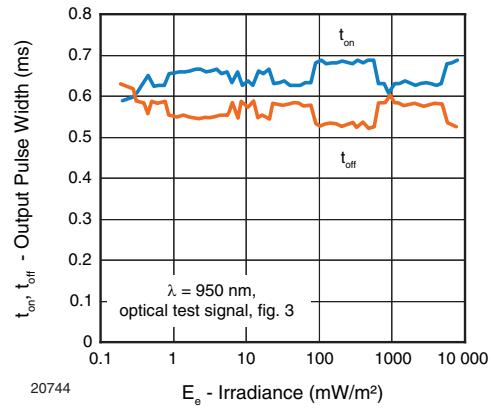

Fig. 4 - Output Pulse Diagram

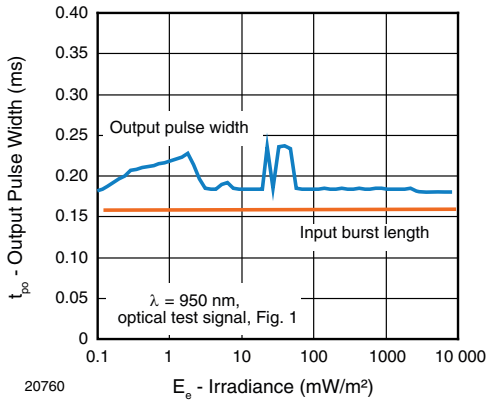

Fig. 2 - Pulse Length and Sensitivity in Dark Ambient

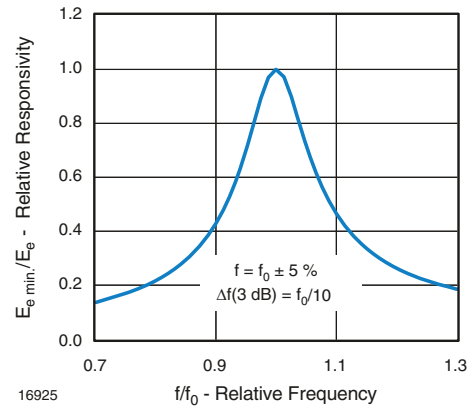

Fig. 5 - Frequency Dependence of Responsivity

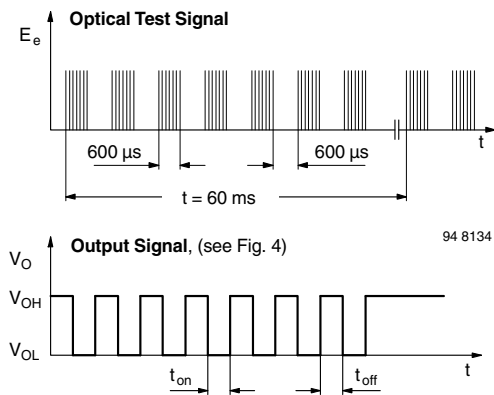

Fig. 3 - Output Function

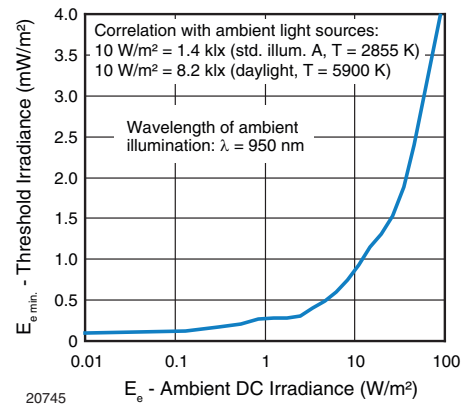

Fig. 6 - Sensitivity in Bright Ambient

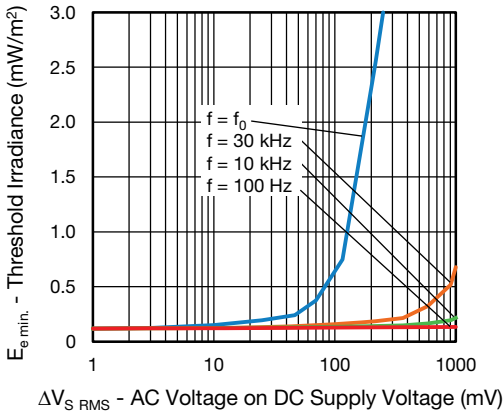

Fig. 7 - Sensitivity vs. Supply Voltage Disturbances

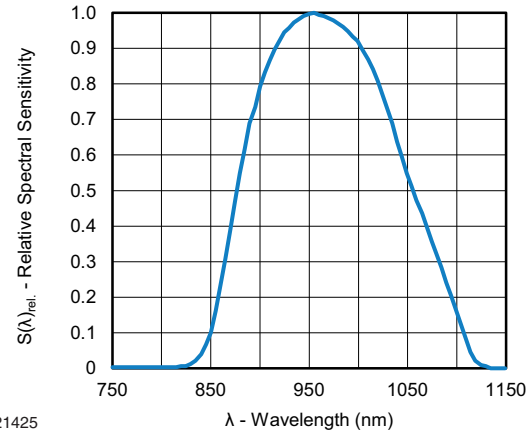

Fig. 10 - Relative Spectral Sensitivity vs. Wavelength

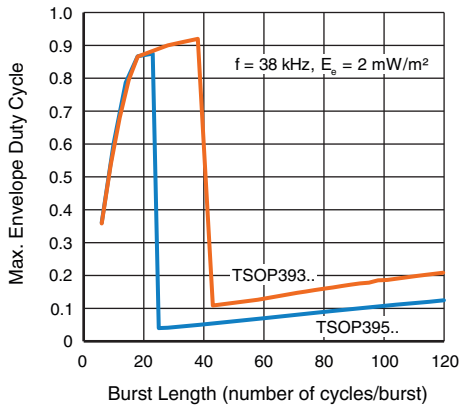

Fig. 8 - Max. Envelope Duty Cycle vs. Burst Length

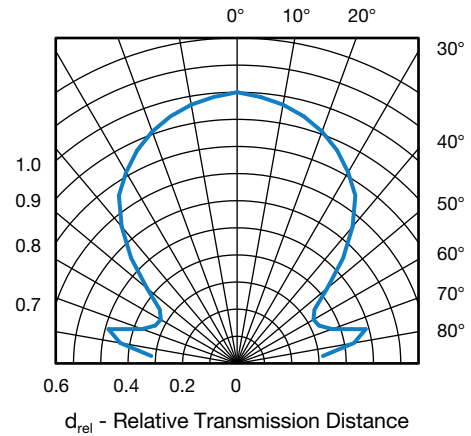

Fig. 11 - Horizontal Directivity

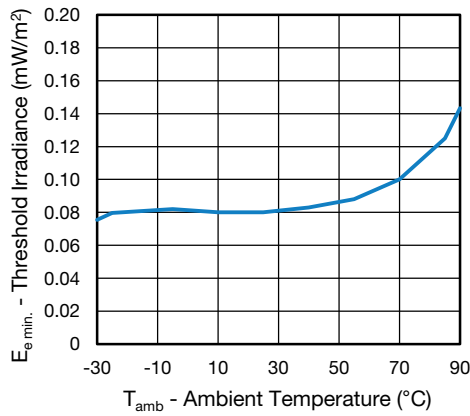

Fig. 9 - Sensitivity vs. Ambient Temperature

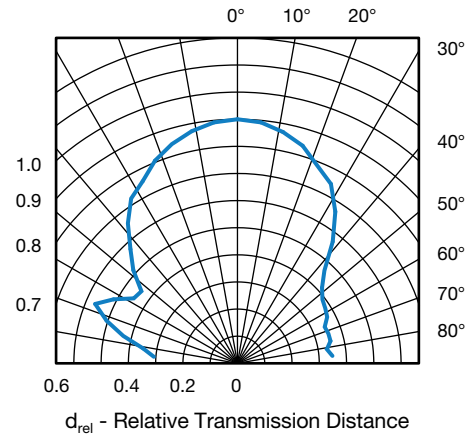

Fig. 12 - Vertical Directivity

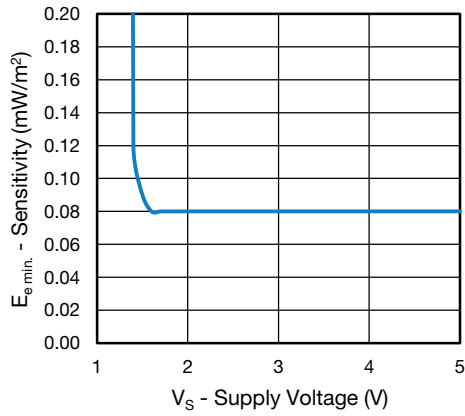

Fig. 13 - Sensitivity vs. Supply Voltage

**SUITABLE DATA FORMAT**

This series is designed to suppress spurious output pulses due to noise or disturbance signals. The devices can distinguish data signals from noise due to differences in frequency, burst length, and envelope duty cycle. The data signal should be close to the device's band-pass center frequency (e.g. 38 kHz) and fulfill the conditions in the table below

When a data signal is applied to the product in the presence of a disturbance, the sensitivity of the receiver is automatically reduced by the AGC to insure that no spurious pulses are present at the receiver's output.

Some examples which are suppressed are:

- DC light (e.g. from tungsten bulbs sunlight)
- Continuous signals at any frequency
- Strongly or weakly modulated pattern from fluorescent lamps with electronic ballasts (see Fig. 14 or Fig. 15)

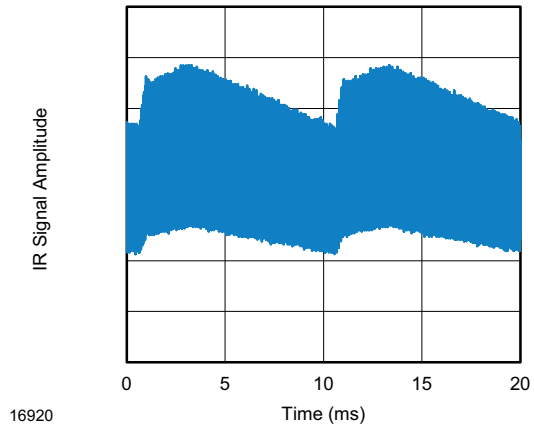

Fig. 14 - IR Disturbance from Fluorescent Lamp With Low Modulation

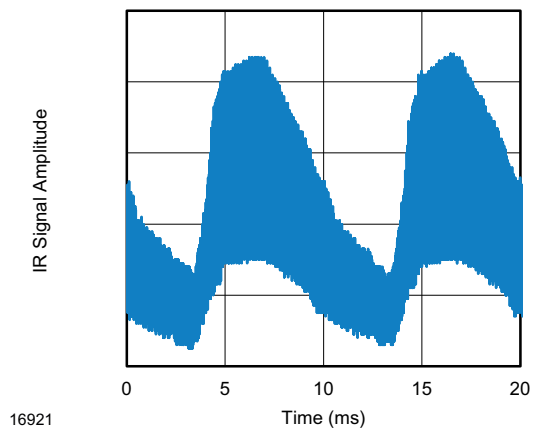

Fig. 15 - IR Disturbance from Fluorescent Lamp With High Modulation

|  | <b>TSOP393..</b>   | <b>TSOP395..</b>  |
|--|--|---|
| Minimum burst length   | 6 cycles/burst   | 6 cycles/burst  |
| After each burst of length a minimum gap time is required of               | 6 to 35 cycles<br>≥ 10 cycles  | 6 to 24 cycles<br>≥ 10 cycles   |
| For bursts greater than a minimum gap time in the data stream is needed of | 35 cycles<br>> 4 x burst length  | 24 cycles<br>> 25 ms  |
| Maximum number of continuous short bursts/second                           | 2000   | 2000  |
| MCIR code  | Preferred  | Yes   |
| XMP-1, XMP-2 code  | Preferred  | Yes   |
| Suppression of interference from fluorescent lamps                         | Mild and complex disturbance patterns are suppressed (example: signal patterns of Fig. 14 and Fig. 15) | Critical disturbance patterns are suppressed, e.g. highly dimmed LCDs |

**Note**

- For data formats with long bursts please see the datasheet for TSOP392.., TSOP394..

## PACKAGE DIMENSIONS in millimeters

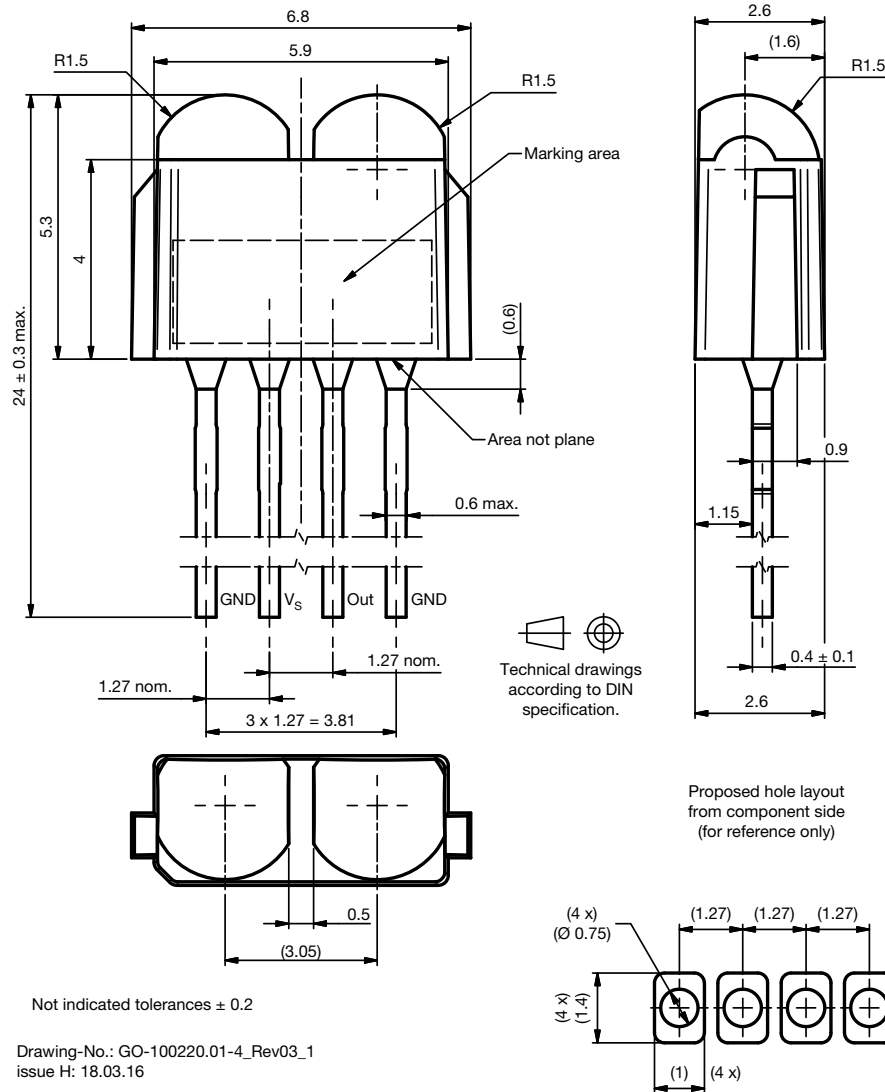

## BULK PACKAGING

Standard shipping for TVCast is in conductive plastic bags. The packing quantity is determined by weight and the number of components per carton may vary by a maximum of ± 0.3 %.

## ORDERING INFORMATION

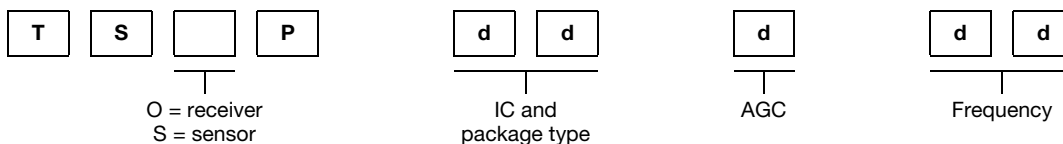

### Note

- d = "digit", please consult the list of available series on the previous page to create a valid part number.

Example: TSOP39338

## PACKAGING QUANTITY

- 400 pieces per bag (each bag is individually boxed)
- 6 bags per carton



## Disclaimer

ALL PRODUCT, PRODUCT SPECIFICATIONS AND DATA ARE SUBJECT TO CHANGE WITHOUT NOTICE TO IMPROVE RELIABILITY, FUNCTION OR DESIGN OR OTHERWISE.

Vishay Intertechnology, Inc., its affiliates, agents, and employees, and all persons acting on its or their behalf (collectively, "Vishay"), disclaim any and all liability for any errors, inaccuracies or incompleteness contained in any datasheet or in any other disclosure relating to any product.

Vishay makes no warranty, representation or guarantee regarding the suitability of the products for any particular purpose or the continuing production of any product. To the maximum extent permitted by applicable law, Vishay disclaims (i) any and all liability arising out of the application or use of any product, (ii) any and all liability, including without limitation special, consequential or incidental damages, and (iii) any and all implied warranties, including warranties of fitness for particular purpose, non-infringement and merchantability.

Statements regarding the suitability of products for certain types of applications are based on Vishay's knowledge of typical requirements that are often placed on Vishay products in generic applications. Such statements are not binding statements about the suitability of products for a particular application. It is the customer's responsibility to validate that a particular product with the properties described in the product specification is suitable for use in a particular application. Parameters provided in datasheets and / or specifications may vary in different applications and performance may vary over time. All operating parameters, including typical parameters, must be validated for each customer application by the customer's technical experts. Product specifications do not expand or otherwise modify Vishay's terms and conditions of purchase, including but not limited to the warranty expressed therein.

Hyperlinks included in this datasheet may direct users to third-party websites. These links are provided as a convenience and for informational purposes only. Inclusion of these hyperlinks does not constitute an endorsement or an approval by Vishay of any of the products, services or opinions of the corporation, organization or individual associated with the third-party website. Vishay disclaims any and all liability and bears no responsibility for the accuracy, legality or content of the third-party website or for that of subsequent links.

Except as expressly indicated in writing, Vishay products are not designed for use in medical, life-saving, or life-sustaining applications or for any other application in which the failure of the Vishay product could result in personal injury or death. Customers using or selling Vishay products not expressly indicated for use in such applications do so at their own risk. Please contact authorized Vishay personnel to obtain written terms and conditions regarding products designed for such applications.

No license, express or implied, by estoppel or otherwise, to any intellectual property rights is granted by this document or by any conduct of Vishay. Product names and markings noted herein may be trademarks of their respective owners.