

Series 284

16mm Precision Rotary Potentiometer

- Conductive Plastic Element
- 16mm x 6mm Compact Size
- Up to 3 Million Life Cycles
- 2% Precision Linearity Option
- Ingression Protection Rating Options
- Wide Operating Temperature Range
- Solder Lug Terminal
- Variety of Shaft and Bushing Lengths



Description

Series 284 Rotary Potentiometer provides the user with a robust, long life, highly reliable product in a sealed housing which complies ingress protection rating of up to IP67. Options include various shaft and bushing lengths, shaft styles, resistance values and tolerances, and rotational angle options to meet application requirements.

Ordering Information

Series	Terminal Style	Bushing Length "A"	Shaft Length "L"	Shaft Trim	Resistance Code	Resistance Tolerance	Linearity	IP Rating	Effective Electrical Angle	A/R Lug Options
284	T	A	A	R	103	A	2	4	B	1

Code	Spec.
T	Solder Lug

Code	Spec.
2	.250" (6.35mm)
3	.375" (9.53mm)
8	1.000" (25.4mm)
<i>Diameter: 1/4" - 32UNEF-2A</i>	
<i>Length increment: 1/8"</i>	
A	5.0mm (.196")
B	7.5mm (.295")
C	10.0mm (.393")
<i>Diameter: M7 x .75P</i>	
<i>Length increment: 2.5mm</i>	

Code	Spec.
R	Round
F	Flatted
Split Knurl	
K	(Available on M7 bushing only)
S	Slotted

Code	Spec.
1	.625" (15.8mm)
2	.750" (18.4mm)
3	.875" (22.2mm)
4	1.000" (25.4mm)
5	1.125" (28.5mm)
<i>Diameter: 1/8"</i>	
<i>Length increment: 1/8"</i>	
A	10mm (.393")
B	15mm (.590")
C	20mm (.787")
D	25mm (.984")
E	30mm (1.181")
<i>Diameter: 6mm</i>	
<i>Length increment: 5mm</i>	

Code	Resistance
102	1 kΩ
103	10 kΩ
503	50 kΩ
104	100 kΩ
504	500 kΩ

Code	Spec.
A	±10%
B	±20%

Code	Spec.
4	IP40
5	IP54
6	IP67

Code	Spec.
2	±2%
4	±4%

Code	Spec.
A	220°
B	60°

Code	Spec.
1	Left side (7.3mm)

Electrical Specifications

Parameter	Conditions & Remarks	Min	Max	Unit
Resistance Range	Linear	1k	500k	Ω
Resistance Tolerance	Standard	-20	+20	%
	Special	-10	+10	%
Dielectric Strength	1 minute		500	VDC
Power Rating	@ 55°C		0.25	watt
Operating Voltage			350	VDC
Insulation Resistance	100 VDC	100		MΩ
Linearity		-2	+2	%
Effective Electrical Angle	See ordering information			

Mechanical and Environmental

Parameter	Conditions & Remarks	Min	Max	Unit
Operating Temperature Range		-40	+125	°C
Storage Temperature		-55	+150	°C
Rotational Torque	IP40	3	30	gf-cm
	IP54 & IP67	20	120	gf-cm
Rotational Life	220° EEA	2,000,000		cycles
		3,000,000		cycles
Mechanical Angle			250	°
Stop Strength		9		kgf-cm
Vibration	15G, 10 to 2000 Hz			
Push-Pull Strength of Shaft:	13.6 kg for 10 seconds			
Ingress Protection Rating	IP40, IP54 & IP67			
Soldering Condition:	Maximum temperature of 260° for 5 seconds			
Packaging:	Standard tray packaging			

All testing is performed at room ambient conditions except as noted. Users should verify device actual performance in their specific applications. This product is compliant to RoHS3 Directive 2015/863 Amendments of Annex II on 31 March 2015, and REACH SVHC Directive EC 1907/2006 Amendments of Annex XIV & Annex XVII on 15 January 2018. Custom and value-added options available on request. Please contact your sales representative for additional information.

Electrical and Mechanical and Specifications

Series 284 Metal Shaft, Bushing Mount, Solder Lug Terminal

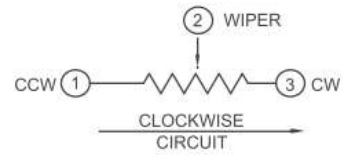
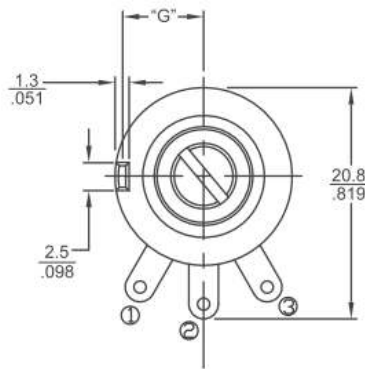
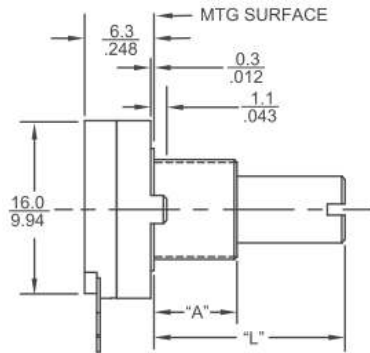

DIMENSION: $\frac{\text{mm}}{\text{inch}}$

Shaft Trim

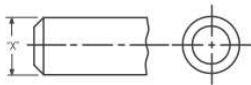

R – Round

	X
Imperial Shaft	.125"
Metric Shaft	6.00

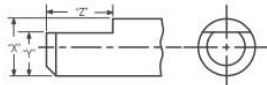

F – Flatted

	X	Y	Z
Imperial Shaft	.125"	.076"	.156"
Metric Shaft	6.00	4.00	5.00

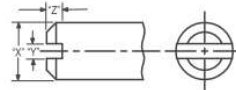

S – Slotted

	X	Y	Z
Imperial Shaft	.125"	.039"	.047"
Metric Shaft	6.00	1.57	1.00

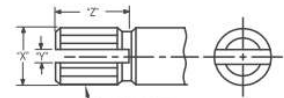

K – Split Knurled

	X	Y	Z
Imperial Shaft	.236"	.062"	.157"
Metric Shaft	6.00	1.57	4.00

*Split knurled shafts available with M7 thread size only.