

# MPEG Clock Generator with VCXO

## Features

- Integrated phase-locked loop (PLL)
- Low-jitter, high-accuracy outputs
- VCXO with analog adjust
- 3.3V operation

## Benefits

- Highest-performance PLL tailored for multimedia applications
- Meets critical timing requirements in complex system designs
- Application compatibility for a wide variety of designs

Table 1. Frequency Table

Part Number	Outputs	Input Frequency Range	Output Frequencies	VCXO Control Curve	Other Features
CY241V08A-11	1	13.5-MHz pullable crystal input per Cypress specification	One copy of 54 MHz	linear	Pinout-compatible with CY2411

## Block Diagram

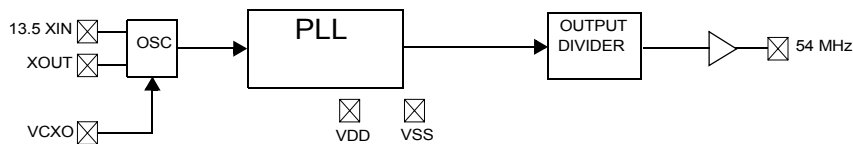

## Pin Configuration

### CY241V08A-11 8-pin SOIC

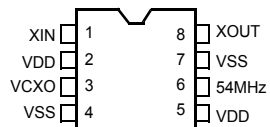

**Pin Descriptions**

<b>Name</b>	<b>Pin Number</b>	<b>Description</b>
XIN	1	Reference crystal input.
VDD	2,5	Voltage supply.
VCXO	3	Input analog control for VCXO.
VSS	4,7	Ground.
54MHz	6	54MHz clock output.
XOUT	8	Reference crystal output.

**Absolute Maximum Conditions**

Supply Voltage ( $V_{DD}$ ) ..... -0.5 to +7.0V  
 DC Input Voltage ..... -0.5V to  $V_{DD} + 0.5$   
 Storage Temperature (Non-condensing)..... -55°C to +125°C  
 Junction Temperature ..... -40°C to +125°C

Data Retention @  $T_j = 125^\circ\text{C}$ ..... > 10 years  
 Package Power Dissipation ..... 350 mW  
 ESD (Human Body Model) MIL-STD-883..... > 2000V  
 (Above which the useful life may be impaired. For user guidelines, not tested.)

**Pullable Crystal Specifications<sup>[1]</sup>**

Parameter	Description	Comments	Min.	Typ.	Max.	Unit
$F_{NOM}$	Nominal crystal frequency	Parallel resonance, fundamental mode, AT cut	-	13.5	-	MHz
$C_{L NOM}$	Nominal load capacitance		-	14	-	pF
$R_1$	Equivalent series resistance (ESR)	Fundamental mode	-	-	25	$\Omega$
$R_3/R_1$	Ratio of third overtone mode ESR to fundamental mode ESR	Ratio used because typical $R_1$ values are much less than the maximum spec	3	-	-	-
DL	Crystal drive level	No external series resistor assumed	150	-	-	$\mu\text{W}$
$F_{3SEPHI}$	Third overtone separation from $3 \cdot F_{NOM}$	High side	300	-	-	ppm
$F_{3SEPLO}$	Third overtone separation from $3 \cdot F_{NOM}$	Low side	-	-	-150	ppm
$C_0$	Crystal shunt capacitance		-	-	7	pF
$C_0/C_1$	Ratio of shunt to motional capacitance		180	-	250	-
$C_1$	Crystal motional capacitance		14.4	18	21.6	fF

**Recommended Operating Conditions**

Parameter	Description	Min.	Typ.	Max.	Unit
VDD	Operating Voltage	3.135	3.3	3.465	V
$T_A$	Ambient Temperature	0	-	70	$^\circ\text{C}$
$C_{LOAD}$	Max. Load Capacitance	-	-	15	pF
$t_{PU}$	Power-up time for all $V_{DD}$ pins to reach minimum specified voltage (power ramps must be monotonic)	0.05	-	500	ms

**DC Electrical Specifications**

Parameter	Name	Description	Min.	Typ.	Max.	Unit
$I_{OH}$	Output HIGH Current	$V_{OH} = V_{DD} - 0.5\text{V}$ , $V_{DD} = 3.3\text{V}$	12	24	-	mA
$I_{OL}$	Output LOW Current	$V_{OL} = 0.5\text{V}$ , $V_{DD} = 3.3\text{V}$	12	24	-	mA
$C_{IN}$	Input Capacitance	Except XIN, XOUT pins	-	-	7	pF
$V_{VCXO}$	VCXO Input Range		0	-	$V_{DD}$	V
$f_{\Delta XO}^{[2]}$	VCXO Pullability Range	Low Side	-	-	-115	ppm
		High Side	115	-	-	ppm
$I_{VDD}$	Supply Current		-	30	35	mA

**AC Electrical Specifications ( $V_{DD} = 3.3\text{V}$ )<sup>[3]</sup>**

Parameter <sup>[3]</sup>	Name	Description	Min.	Typ.	Max.	Unit
DC	Output Duty Cycle	Duty Cycle is defined in <i>Figure 1</i> , 50% of $V_{DD}$	45	50	55	%
ER	Rising Edge Rate	Output Clock Edge Rate, Measured from 20% to 80% of $V_{DD}$ , $C_{LOAD} = 15\text{ pF}$ . See <i>Figure 2</i> .	0.8	1.4	-	V/ns
EF	Falling Edge Rate	Output Clock Edge Rate, Measured from 80% to 20% of $V_{DD}$ , $C_{LOAD} = 15\text{ pF}$ . See <i>Figure 2</i> .	0.8	1.4	-	V/ns
$t_g$	Clock Jitter	Peak-to-peak period jitter	-	-	100	ps
$t_{10}$	PLL Lock Time		-	-	3	ms

**Notes:**

- Crystals that meet this specification include: Ecliptek ECX-5788-13.500M, Siward XTL001050A-13.5-14-400, Raltron A-13.500-14-CL, PDI HA13500XFSA14XC.
- 115/+115 ppm assumes 2.5pF of additional board level load capacitance. This range will be shifted down with more board capacitance or shifted up with less board capacitance.
- Not 100% tested.

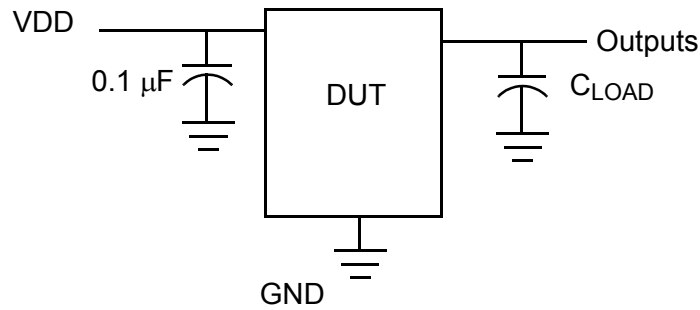
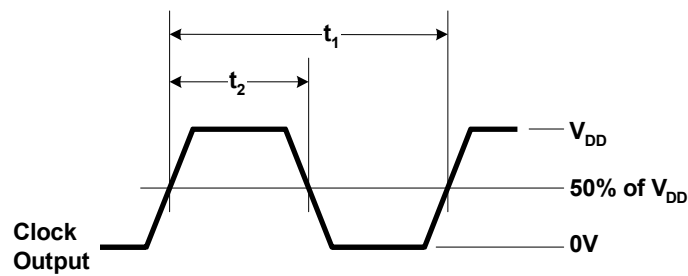
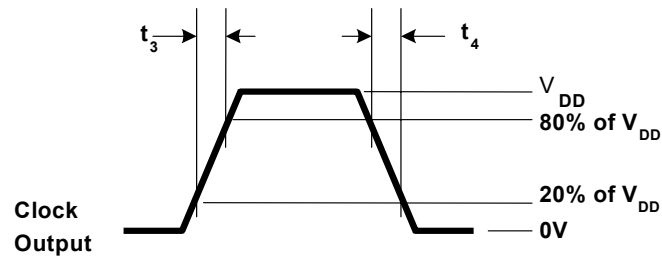
**Test and Measurement Set-up**

**Voltage and Timing Definitions**

**Figure 1. Duty Cycle Definition**

**Figure 2.  $ER = (0.6 \times V_{DD}) / t_3$ ,  $EF = (0.6 \times V_{DD}) / t_4$** 
**Ordering Information**

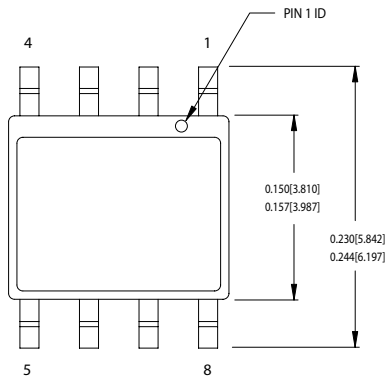
Ordering Code	Package Name	Package Type	Operating Range	Operating Voltage	Features
CY241V08ASC-11	S8	8-pin SOIC	Commercial	3.3V	Linear VCXO control curve
CY241V08ASC-11T	S8	8-pin SOIC – Tape and Reel	Commercial	3.3V	Linear VCXO control curve

Package Drawing and Dimensions

8-lead (150-Mil) SOIC S8



1. DIMENSIONS IN INCHES[MM] MIN. MAX.
2. PIN 1 ID IS OPTIONAL, ROUND ON SINGLE LEADFRAME RECTANGULAR ON MATRIX LEADFRAME
3. REFERENCE JEDEC MS-012
4. PACKAGE WEIGHT 0.07gms

PART #
S08.15 STANDARD PKG.
SZ08.15 LEAD FREE PKG.

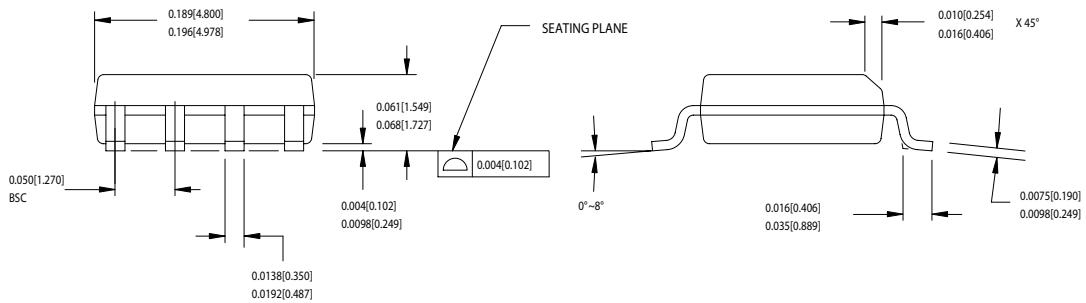

51-85066-°C

All product or company names mentioned in this document may be the trademarks of their respective holders.

**Document History Page**

<b>Document Title: CY241V08A-11 MPEG Clock Generator with VCXO</b> <b>Document Number: 38-07654</b>				
<b>REV.</b>	<b>ECN NO.</b>	<b>Issue Date</b>	<b>Orig. of Change</b>	<b>Description of Change</b>
**	214071	See ECN	RGL	New Data Sheet
*A	220461	See ECN	RGL	Minor Change: To post on web