

Utilizing the latest Field Stop and Trench Gate technologies, these IGBT's have ultra low  $V_{CE(ON)}$  and are ideal for low frequency applications that require absolute minimum conduction loss. Easy paralleling is a result of very tight parameter distribution and a slightly positive  $V_{CE(ON)}$  temperature coefficient. Low gate charge simplifies gate drive design and minimizes losses.

- 600V Field Stop
- Trench Gate: Low  $V_{CE(on)}$
- Easy Paralleling
- 6 $\mu$ s Short Circuit Capability
- 175°C Rated

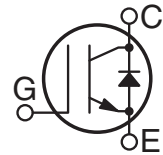
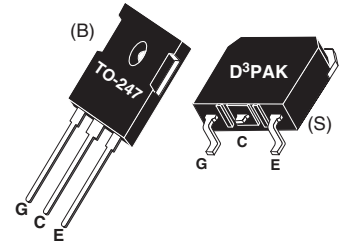

**Applications: Welding, Inductive Heating, Solar Inverters, SMPS, Motor drives, UPS**

### MAXIMUM RATINGS

All Ratings:  $T_C = 25^\circ\text{C}$  unless otherwise specified.

Symbol	Parameter	APT30GN60BD_SDQ2(G)	UNIT
$V_{CES}$	Collector-Emitter Voltage	600	Volts
$V_{GE}$	Gate-Emitter Voltage	$\pm 30$	
$I_{C1}$	Continuous Collector Current @ $T_C = 25^\circ\text{C}$	63	Amps
$I_{C2}$	Continuous Collector Current @ $T_C = 110^\circ\text{C}$	37	
$I_{CM}$	Pulsed Collector Current <sup>①</sup>	90	
SSOA	Switching Safe Operating Area @ $T_J = 150^\circ\text{C}$	90A @ 600V	
$P_D$	Total Power Dissipation	203	Watts
$T_J, T_{STG}$	Operating and Storage Junction Temperature Range	-55 to 175	$^\circ\text{C}$
$T_L$	Max. Lead Temp. for Soldering: 0.063" from Case for 10 Sec.	300	

### STATIC ELECTRICAL CHARACTERISTICS

Symbol	Characteristic / Test Conditions	MIN	TYP	MAX	Units
$V_{(BR)CES}$	Collector-Emitter Breakdown Voltage ( $V_{GE} = 0V, I_C = 2mA$ )	600			Volts
$V_{GE(TH)}$	Gate Threshold Voltage ( $V_{CE} = V_{GE}, I_C = 430\mu A, T_j = 25^\circ\text{C}$ )	5.0	5.8	6.5	
$V_{CE(ON)}$	Collector-Emitter On Voltage ( $V_{GE} = 15V, I_C = 30A, T_j = 25^\circ\text{C}$ )	1.1	1.5	1.9	
	Collector-Emitter On Voltage ( $V_{GE} = 15V, I_C = 30A, T_j = 125^\circ\text{C}$ )		1.7		
$I_{CES}$	Collector Cut-off Current ( $V_{CE} = 600V, V_{GE} = 0V, T_j = 25^\circ\text{C}$ ) <sup>②</sup>			50	$\mu A$
	Collector Cut-off Current ( $V_{CE} = 600V, V_{GE} = 0V, T_j = 125^\circ\text{C}$ ) <sup>②</sup>			TBD	
$I_{GES}$	Gate-Emitter Leakage Current ( $V_{GE} = \pm 20V$ )			300	nA
$R_{G(int)}$	Intergrated Gate Resistor		N/A		$\Omega$



**CAUTION:** These Devices are Sensitive to Electrostatic Discharge. Proper Handling Procedures Should Be Followed.

## DYNAMIC CHARACTERISTICS

APT30GN60BD\_SDQ2(G)

Symbol	Characteristic	Test Conditions	MIN	TYP	MAX	UNIT	
$C_{ies}$	Input Capacitance	<b>Capacitance</b> $V_{GE} = 0V, V_{CE} = 25V$ $f = 1 \text{ MHz}$		1750		pF	
$C_{oes}$	Output Capacitance			70			
$C_{res}$	Reverse Transfer Capacitance			50			
$V_{GEP}$	Gate-to-Emitter Plateau Voltage	Gate Charge $V_{GE} = 15V$ $V_{CE} = 300V$ $I_C = 30A$		9.0		V	
$Q_g$	Total Gate Charge <sup>③</sup>			165			
$Q_{ge}$	Gate-Emitter Charge			10			
$Q_{gc}$	Gate-Collector ("Miller") Charge			90			
SSOA	Switching Safe Operating Area	$T_J = 150^\circ\text{C}, R_G = 4.3\Omega^{⑦}, V_{GE} = 15V, L = 100\mu\text{H}, V_{CE} = 600V$	90			A	
SCSOA	Short Circuit Safe Operating Area	$V_{CC} = 360V, V_{GE} = 15V, T_J = 150^\circ\text{C}, R_G = 4.3\Omega^{⑦}$	6			$\mu\text{s}$	
$t_{d(on)}$	Turn-on Delay Time	<b>Inductive Switching (25°C)</b> $V_{CC} = 400V$ $V_{GE} = 15V$ $I_C = 30A$ $R_G = 4.3\Omega^{⑦}$ $T_J = +25^\circ\text{C}$		12		ns	
$t_r$	Current Rise Time			14			
$t_{d(off)}$	Turn-off Delay Time			155			
$t_f$	Current Fall Time			55			
$E_{on1}$	Turn-on Switching Energy <sup>④</sup>				525		$\mu\text{J}$
$E_{on2}$	Turn-on Switching Energy (With Diode) <sup>⑤</sup>				565		
$E_{off}$	Turn-off Switching Energy <sup>⑥</sup>				700		
$t_{d(on)}$	Turn-on Delay Time		<b>Inductive Switching (125°C)</b> $V_{CC} = 400V$ $V_{GE} = 15V$ $I_C = 30A$ $R_G = 4.3\Omega^{⑦}$ $T_J = +125^\circ\text{C}$		12		ns
$t_r$	Current Rise Time				14		
$t_{d(off)}$	Turn-off Delay Time				180		
$t_f$	Current Fall Time			75			
$E_{on1}$	Turn-on Switching Energy <sup>④</sup>				555		$\mu\text{J}$
$E_{on2}$	Turn-on Switching Energy (With Diode) <sup>⑤</sup>				950		
$E_{off}$	Turn-off Switching Energy <sup>⑥</sup>				895		

## THERMAL AND MECHANICAL CHARACTERISTICS

Symbol	Characteristic	MIN	TYP	MAX	UNIT
$R_{\theta JC}$	Junction to Case ( <b>IGBT</b> )			.74	$^\circ\text{C/W}$
$R_{\theta JC}$	Junction to Case ( <b>DIODE</b> )			.67	
$W_T$	Package Weight		5.9		gm

① Repetitive Rating: Pulse width limited by maximum junction temperature.

② For Combi devices,  $I_{ces}$  includes both IGBT and diode leakages

③ See MIL-STD-750 Method 3471.

④  $E_{on1}$  is the clamped inductive turn-on energy of the IGBT only, without the effect of a commutating diode reverse recovery current adding to the IGBT turn-on loss. Tested in inductive switching test circuit shown in figure 21, but with a Silicon Carbide diode.

⑤  $E_{on2}$  is the clamped inductive turn-on energy that includes a commutating diode reverse recovery current in the IGBT turn-on switching loss. (See Figures 21, 22.)

⑥  $E_{off}$  is the clamped inductive turn-off energy measured in accordance with JEDEC standard JESD24-1. (See Figures 21, 23.)

⑦  $R_G$  is external gate resistance, not including  $R_{Gint}$  nor gate driver impedance. (MIC4452)

Microsemi reserves the right to change, without notice, the specifications and information contained herein.

# TYPICAL PERFORMANCE CURVES

APT30GN60BD\_SDQ2(G)

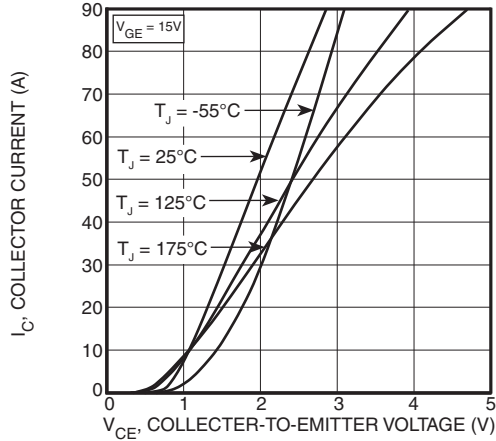

FIGURE 1, Output Characteristics ( $T_J = 25^\circ\text{C}$ )

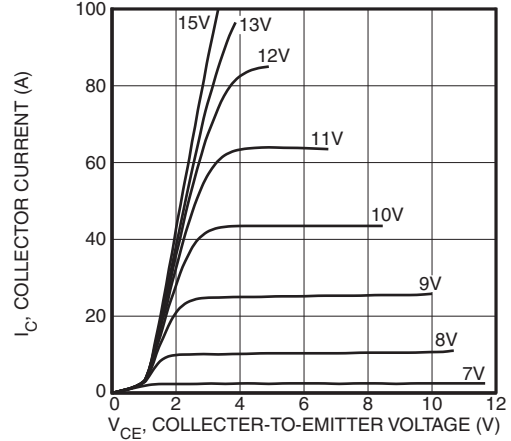

FIGURE 2, Output Characteristics ( $T_J = 125^\circ\text{C}$ )

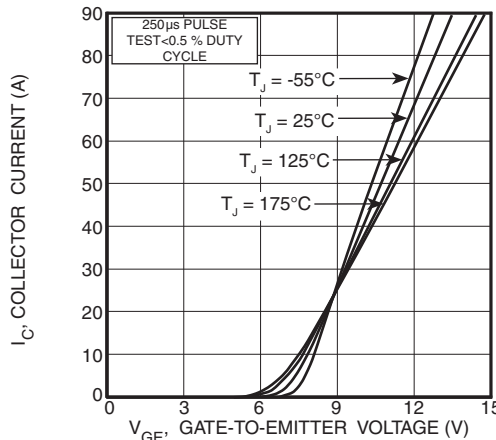

FIGURE 3, Transfer Characteristics

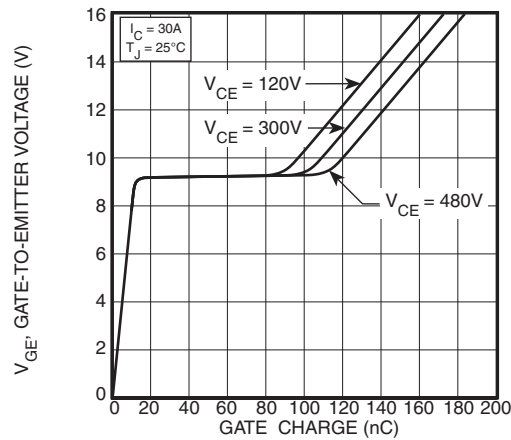

FIGURE 4, Gate Charge

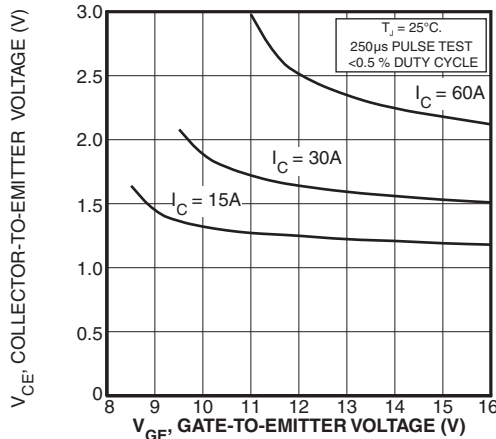

FIGURE 5, On State Voltage vs Gate-to-Emitter Voltage

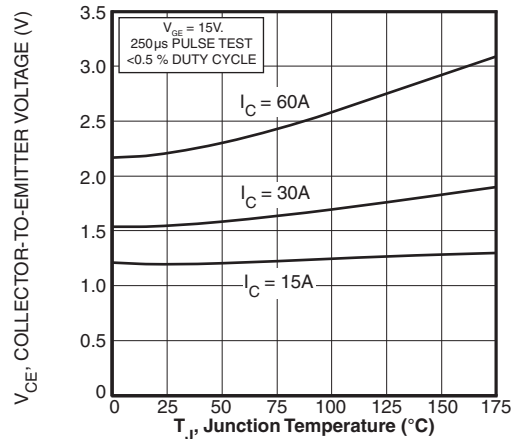

FIGURE 6, On State Voltage vs Junction Temperature

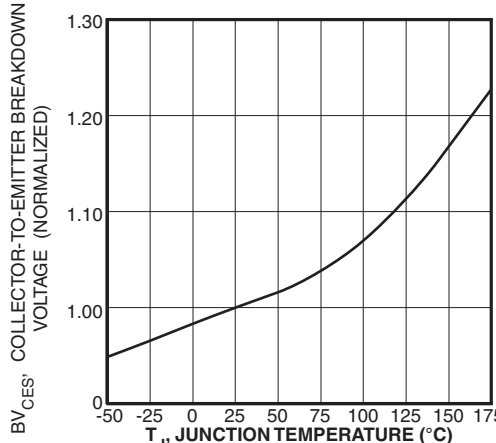

FIGURE 7, Breakdown Voltage vs. Junction Temperature

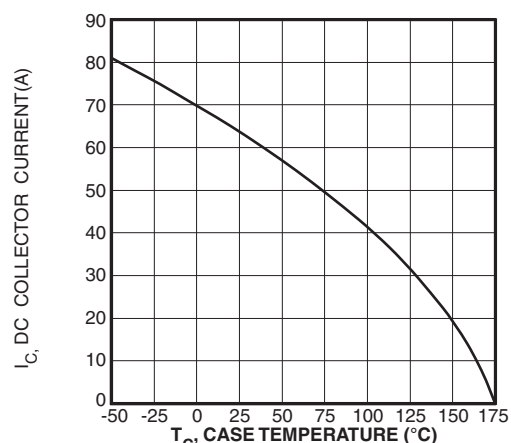

FIGURE 8, DC Collector Current vs Case Temperature

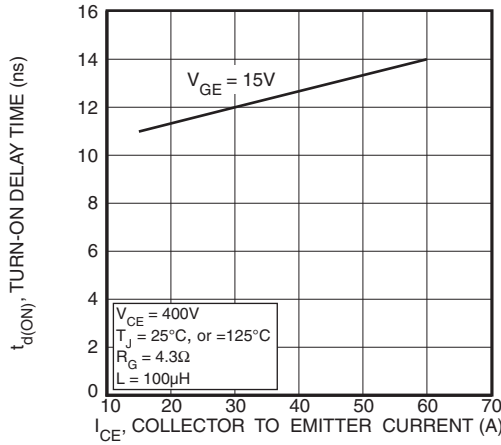

FIGURE 9, Turn-On Delay Time vs Collector Current

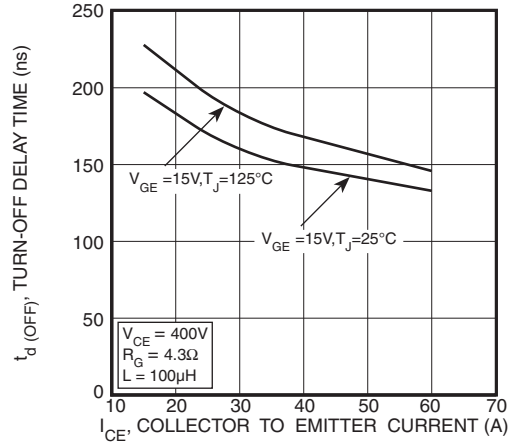

FIGURE 10, Turn-Off Delay Time vs Collector Current

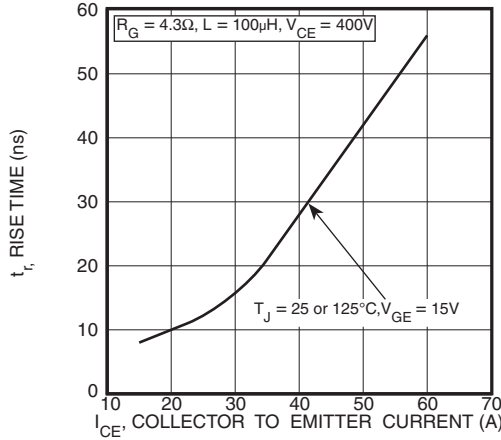

FIGURE 11, Current Rise Time vs Collector Current

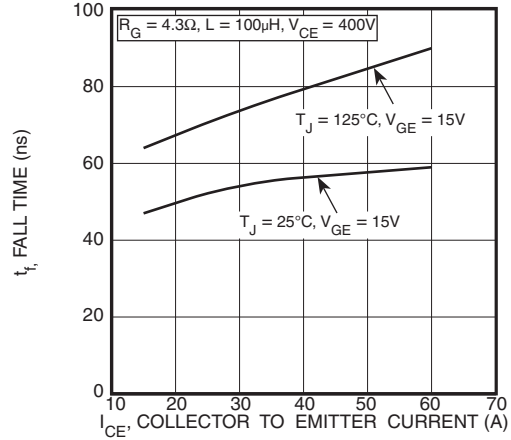

FIGURE 12, Current Fall Time vs Collector Current

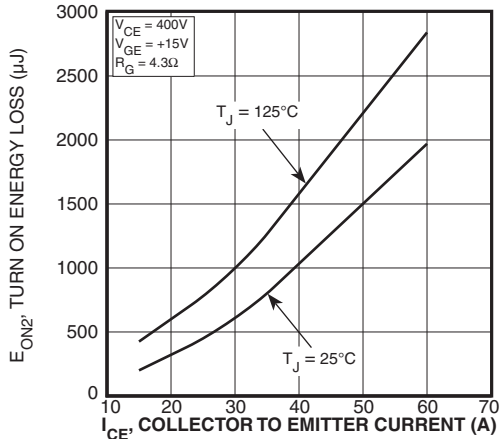

FIGURE 13, Turn-On Energy Loss vs Collector Current

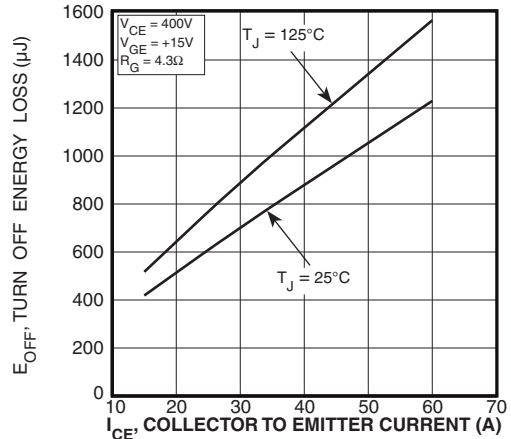

FIGURE 14, Turn Off Energy Loss vs Collector Current

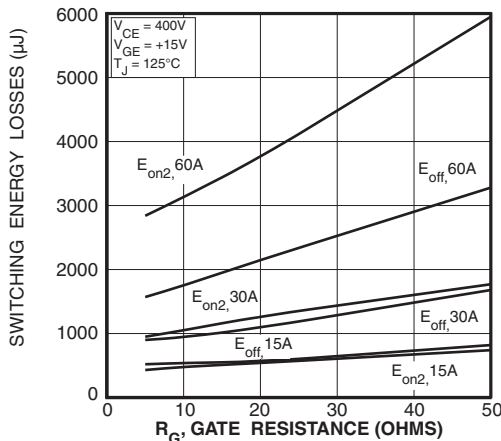

FIGURE 15, Switching Energy Losses vs. Gate Resistance

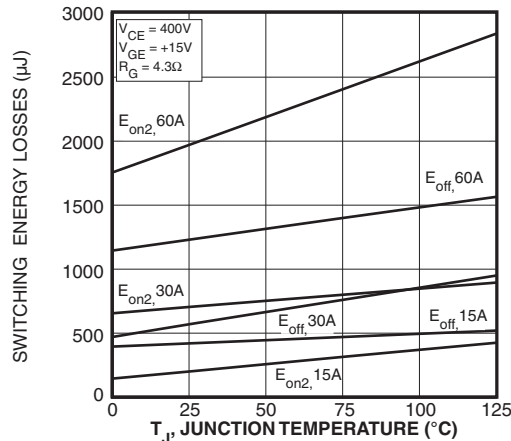

FIGURE 16, Switching Energy Losses vs Junction Temperature

### TYPICAL PERFORMANCE CURVES

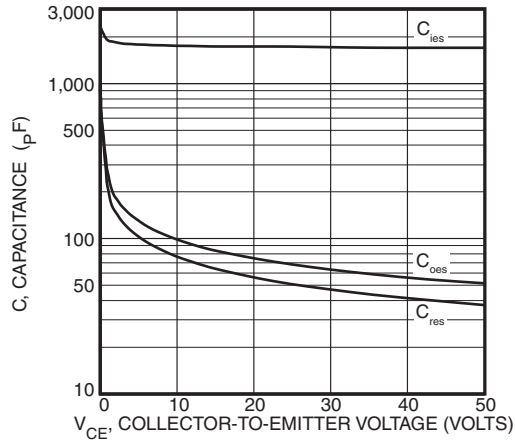

Figure 17, Capacitance vs Collector-To-Emitter Voltage

### APT30GN60BD\_SDQ2(G)

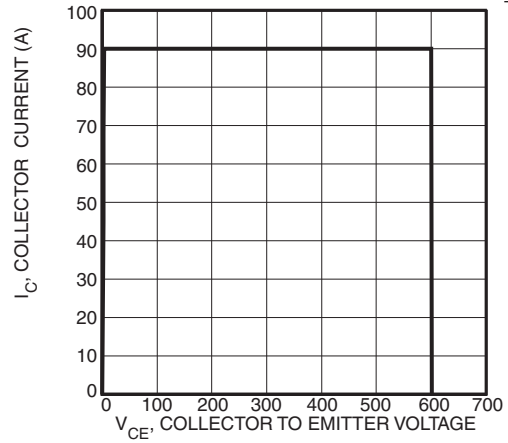

Figure 18, Minimum Switching Safe Operating Area

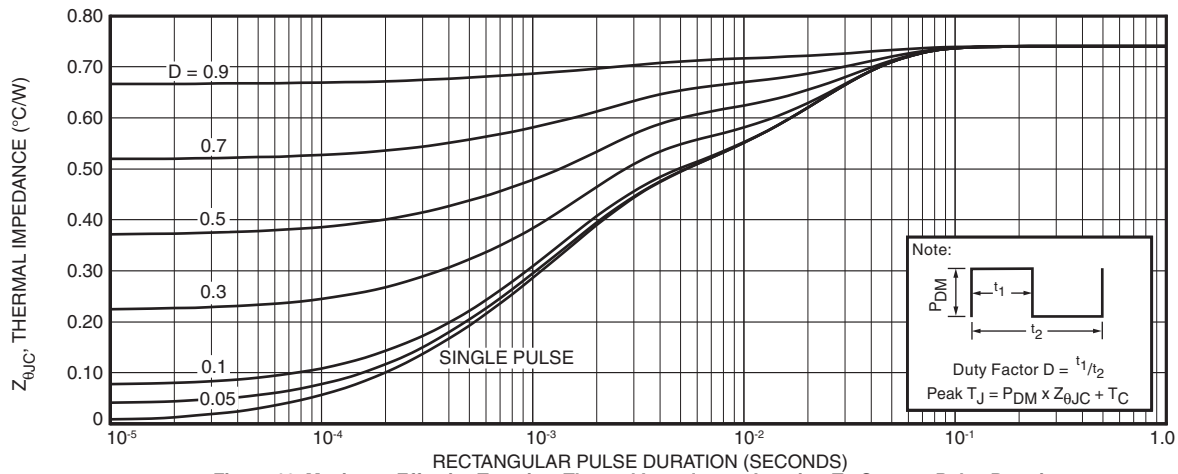

Figure 19, Maximum Effective Transient Thermal Impedance, Junction-To-Case vs Pulse Duration

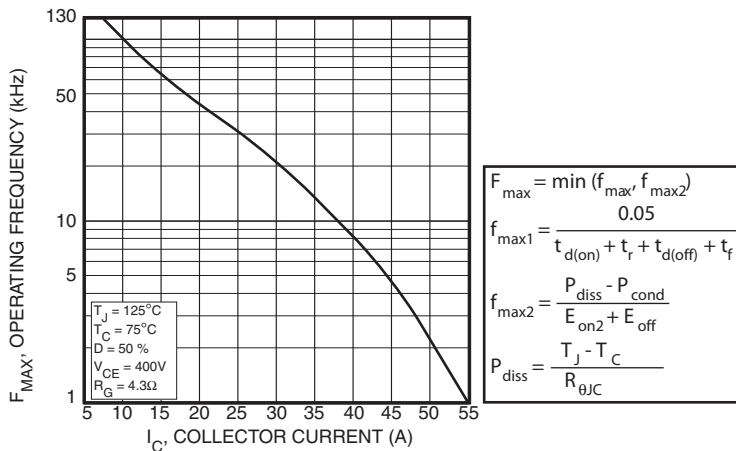

Figure 20, Operating Frequency vs Collector Current

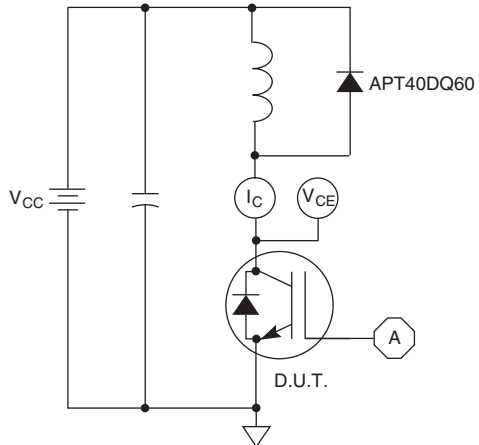

Figure 21, Inductive Switching Test Circuit

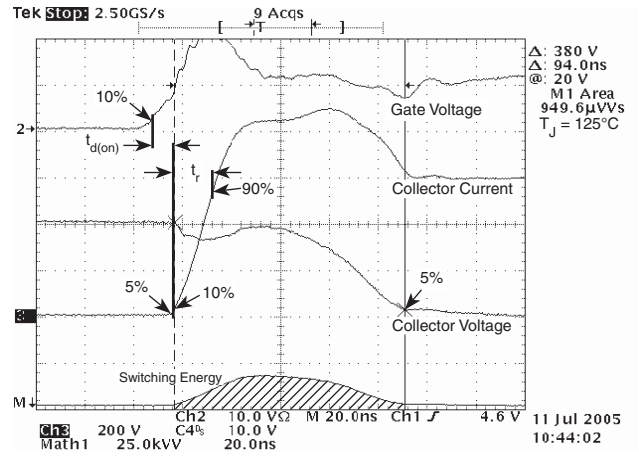

Figure 22, Turn-on Switching Waveforms and Definitions

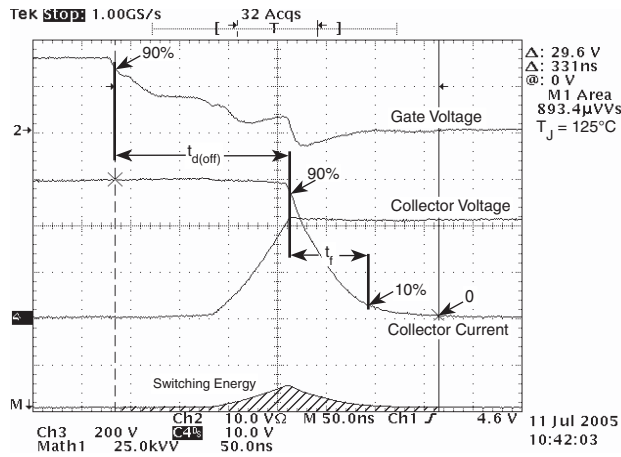

Figure 23, Turn-off Switching Waveforms and Definitions

# ULTRAFAST SOFT RECOVERY ANTI-PARALLEL DIODE

## MAXIMUM RATINGS

All Ratings:  $T_C = 25^\circ\text{C}$  unless otherwise specified.

Symbol	Characteristic / Test Conditions	APT30GN60BD_SDQ2(G)		UNIT
$I_{F(AV)}$	Maximum Average Forward Current ( $T_C = 111^\circ\text{C}$ , Duty Cycle = 0.5)		40	Amps
$I_{F(RMS)}$	RMS Forward Current (Square wave, 50% duty)		63	
$I_{FSM}$	Non-Repetitive Forward Surge Current ( $T_J = 45^\circ\text{C}$ , 8.3ms)		320	

## STATIC ELECTRICAL CHARACTERISTICS

Symbol	Characteristic / Test Conditions	MIN	TYP	MAX	UNIT
$V_F$	Forward Voltage		$I_F = 30\text{A}$	1.85	Volts
			$I_F = 60\text{A}$	2.27	
			$I_F = 30\text{A}, T_J = 125^\circ\text{C}$	1.5	

## DYNAMIC CHARACTERISTICS

Symbol	Characteristic	Test Conditions	MIN	TYP	MAX	UNIT
$t_{rr}$	Reverse Recovery Time	$I_F = 1\text{A}, di_F/dt = -100\text{A}/\mu\text{s}, V_R = 30\text{V}, T_J = 25^\circ\text{C}$	-	22		ns
$t_{rr}$	Reverse Recovery Time	$I_F = 40\text{A}, di_F/dt = -200\text{A}/\mu\text{s}, V_R = 400\text{V}, T_C = 25^\circ\text{C}$	-	25		
$Q_{rr}$	Reverse Recovery Charge		-	35		nC
$I_{RRM}$	Maximum Reverse Recovery Current		-	3	-	Amps
$t_{rr}$	Reverse Recovery Time	$I_F = 40\text{A}, di_F/dt = -200\text{A}/\mu\text{s}, V_R = 400\text{V}, T_C = 125^\circ\text{C}$	-	160		ns
$Q_{rr}$	Reverse Recovery Charge		-	480		nC
$I_{RRM}$	Maximum Reverse Recovery Current		-	6	-	Amps
$t_{rr}$	Reverse Recovery Time	$I_F = 40\text{A}, di_F/dt = -1000\text{A}/\mu\text{s}, V_R = 400\text{V}, T_C = 125^\circ\text{C}$	-	85		ns
$Q_{rr}$	Reverse Recovery Charge		-	920		nC
$I_{RRM}$	Maximum Reverse Recovery Current		-	20		Amps

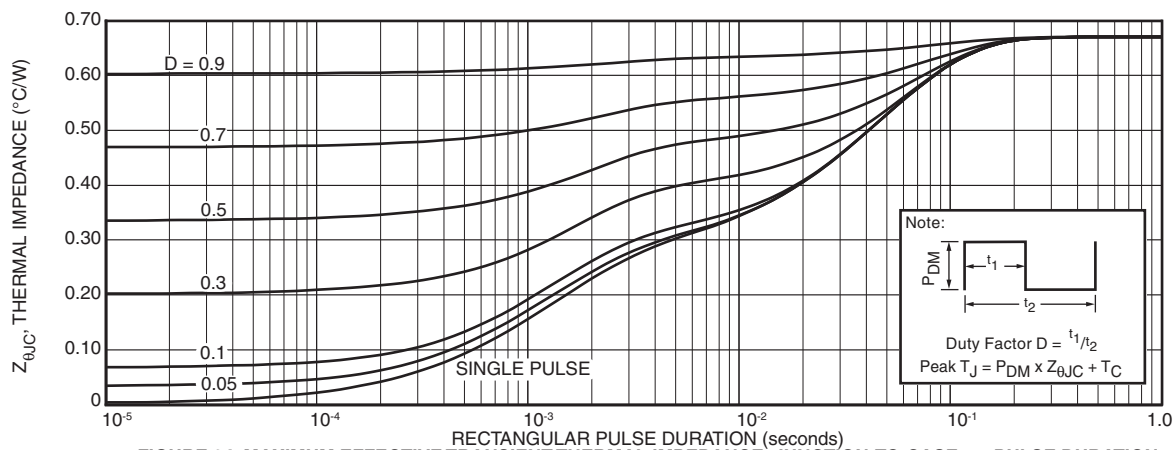

FIGURE 24. MAXIMUM EFFECTIVE TRANSIENT THERMAL IMPEDANCE, JUNCTION-TO-CASE vs. PULSE DURATION

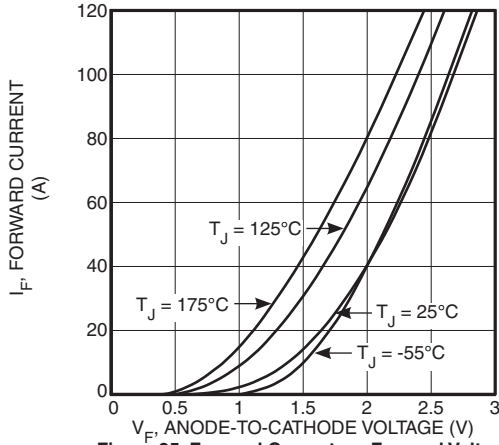

Figure 25. Forward Current vs. Forward Voltage

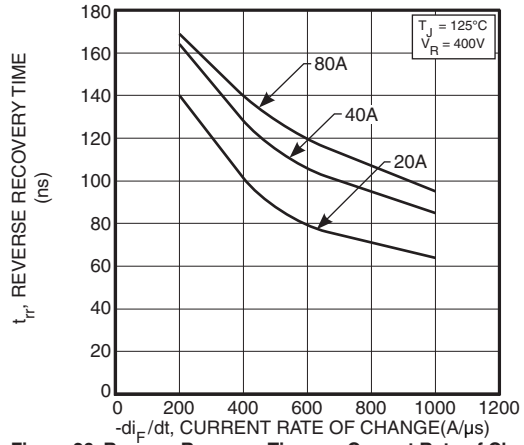

Figure 26. Reverse Recovery Time vs. Current Rate of Change

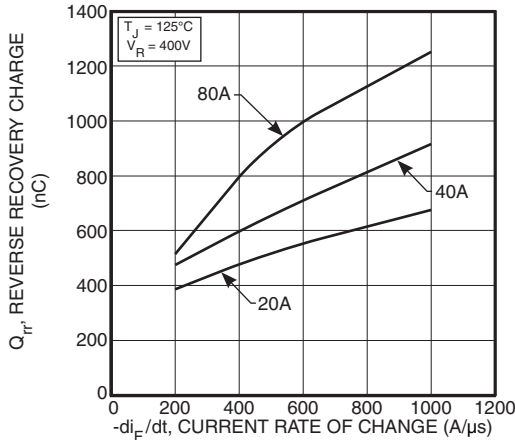

Figure 27. Reverse Recovery Charge vs. Current Rate of Change

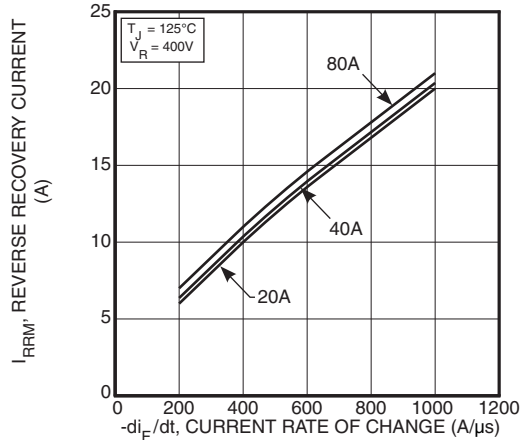

Figure 28. Reverse Recovery Current vs. Current Rate of Change

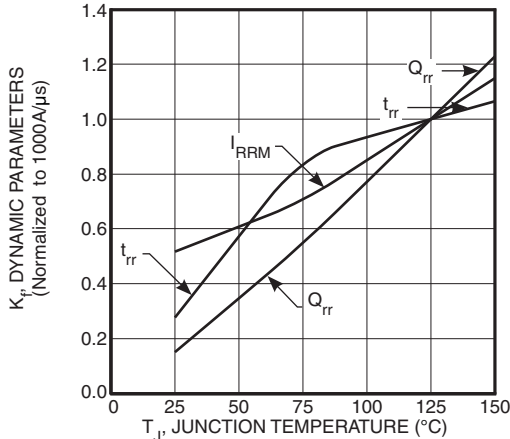

Figure 29. Dynamic Parameters vs. Junction Temperature

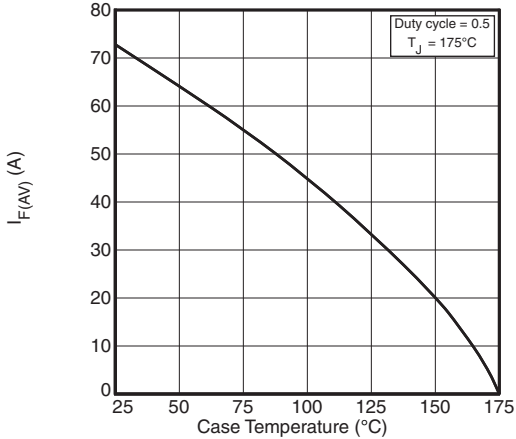

Figure 30. Maximum Average Forward Current vs. Case Temperature

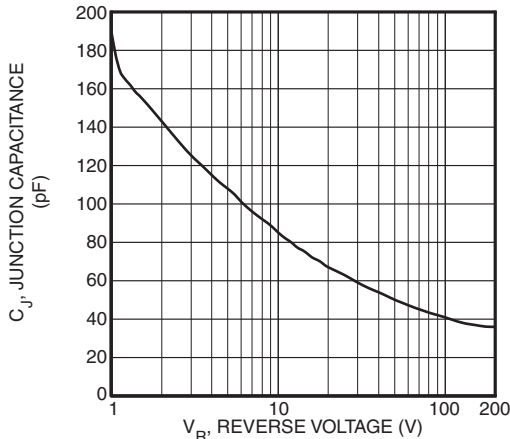

Figure 31. Junction Capacitance vs. Reverse Voltage



# TYPICAL PERFORMANCE CURVES

APT30GN60BD\_SDQ2(G)

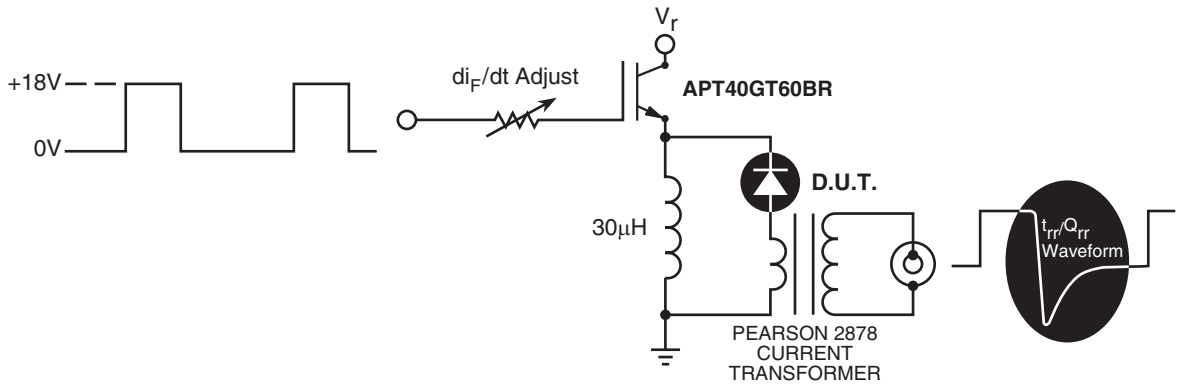

Figure 32. Diode Test Circuit

- 1  $I_F$  - Forward Conduction Current
- 2  $di_F/dt$  - Rate of Diode Current Change Through Zero Crossing.
- 3  $I_{RRM}$  - Maximum Reverse Recovery Current.
- 4  $t_{rr}$  - Reverse Recovery Time, measured from zero crossing where diode current goes from positive to negative, to the point at which the straight line through  $I_{RRM}$  and  $0.25 \cdot I_{RRM}$  passes through zero.
- 5  $Q_{rr}$  - Area Under the Curve Defined by  $I_{RRM}$  and  $t_{rr}$ .

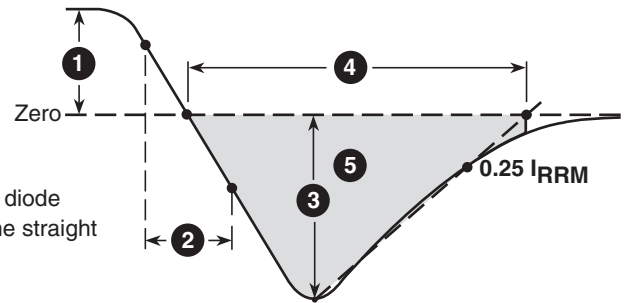
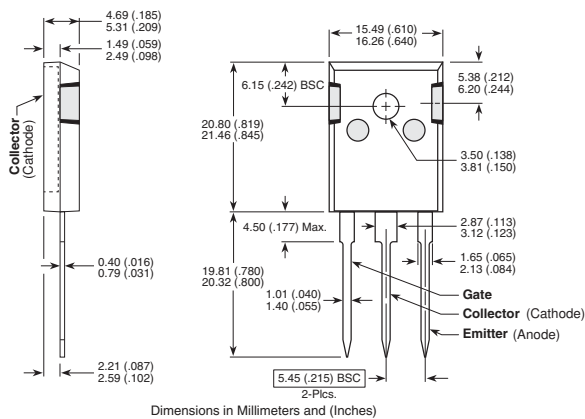

Figure 33. Diode Reverse Recovery Waveform and Definitions

## TO-247 Package Outline

e1 SAC: Tin, Silver, Copper



## D<sup>3</sup>PAK Package Outline

e3 SAC: Tin, Silver, Copper

